



MICRO CONTROL SYSTEMS

Magnum & MicroMag Field Replacement Parts

www.mcscontrols.com



Magnum & MicroMag Parts

MCS PART #	ITEM	MCS PART #	ITEM
25-011	6.3 Amp 250vac Fuse	41-038-4	4pos 5.0mm
25-018	500ma 250vac Fuse	41-038-6	6pos 5.0mm
25-019	2ma 250vac Fuse	92-023	#6 1" pan head screws
25-023	2a 32vac fuse	92-612	1-5/8" Nylon Standoff
25-024	5a 32vac fuse	92-615	Nylon Collar Spacer
41-036-3	3pos 7.5mm	92-616	Nylon Collar Retainer
41-038-3	3pos 5.0mm	40-022	Jumper



Magnum Board Terminal Blocks

11pcs 41-036-3

2pcs 4 - 41-038-4
2pcs 4 - 41-038-3
1pc 4 - 41-038-6

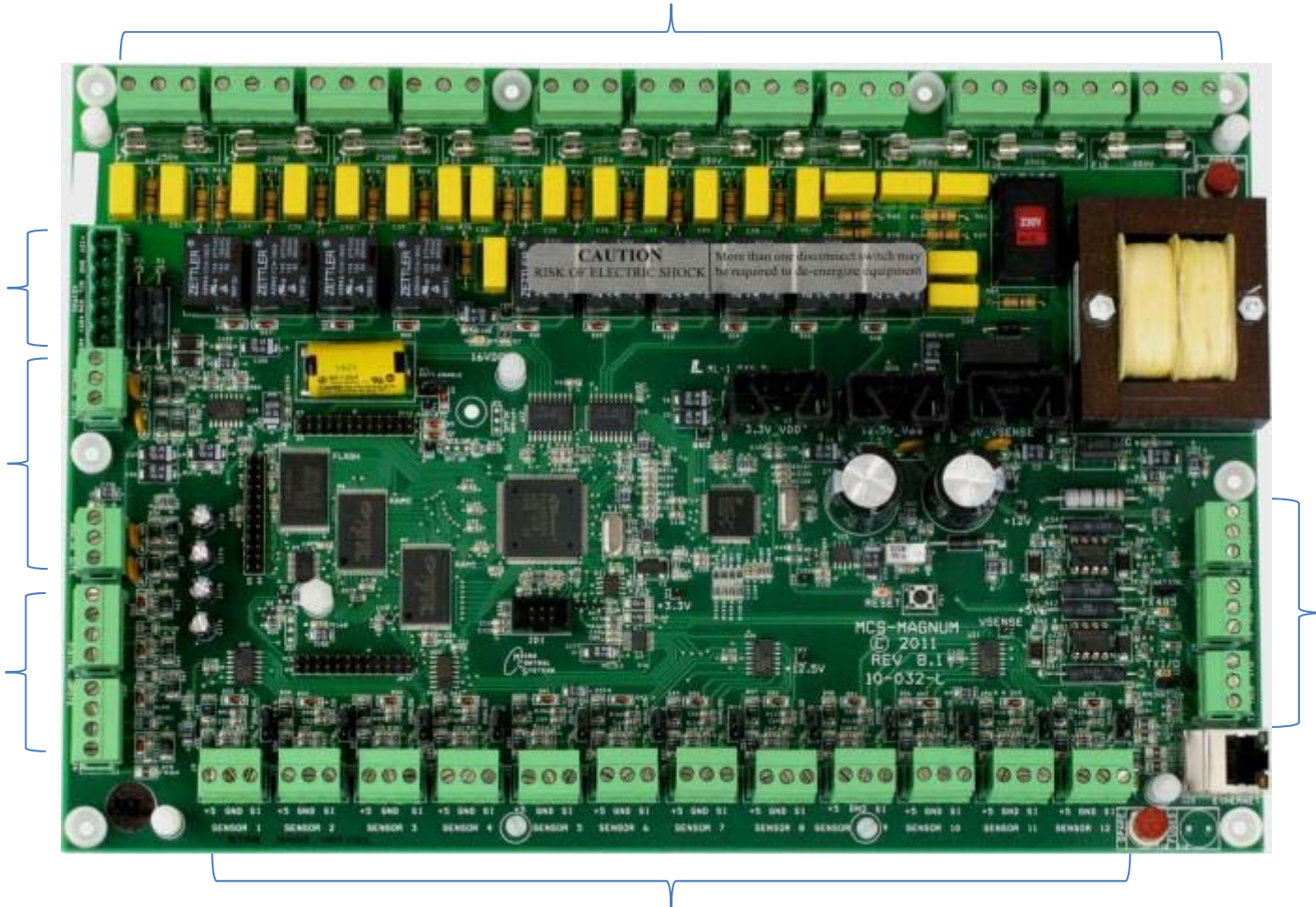

3pcs 41-038-3



File No: E169780 (115vac & 24vac)

12pcs 41-038-3



Magnum Board Fuses

10pcs 25-011

1pcs 25-018 (120/240 vac)
1pcs 25-019 (24vac)

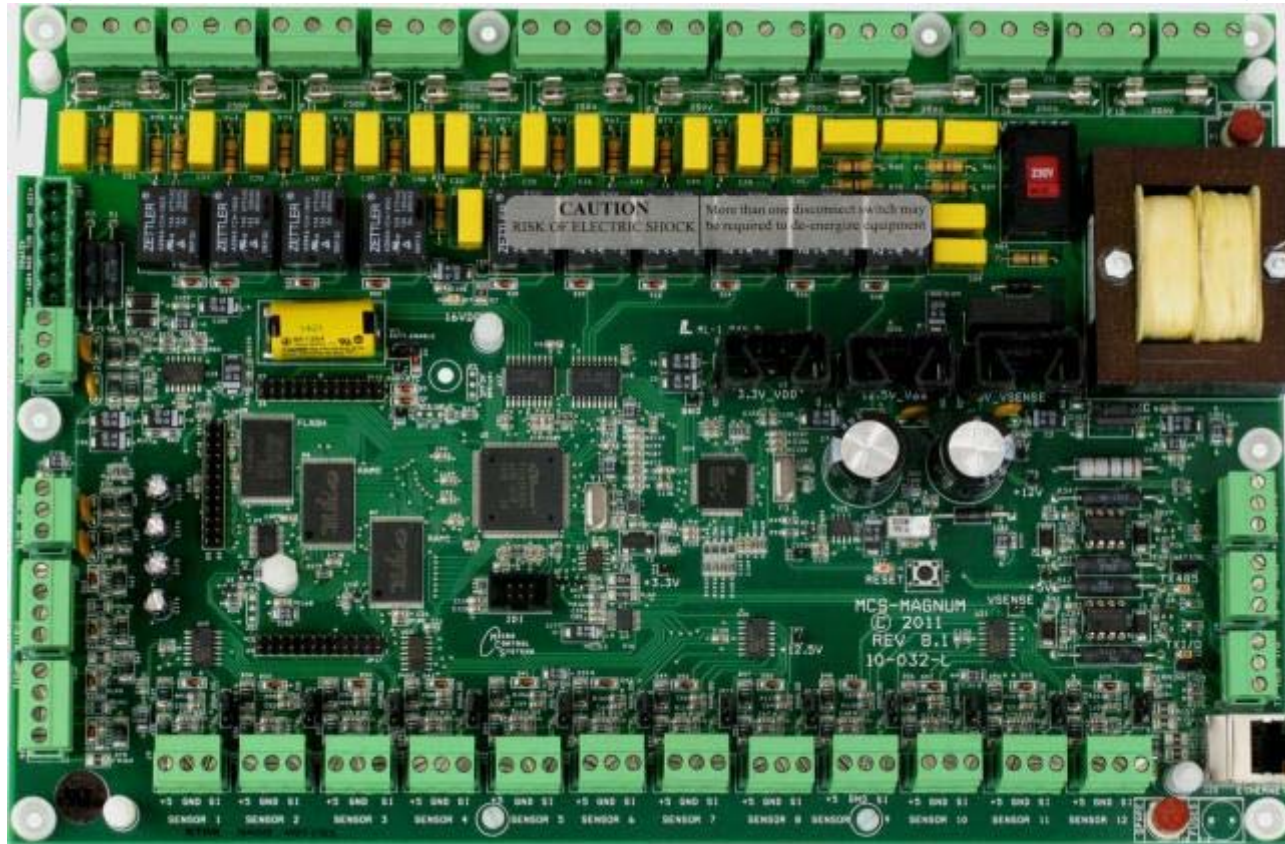

Spare

1pcs 25-018 (120/240 vac)
1pcs 25-019 (24vac)



File No: E169780 (115vac & 24vac)



Magnum Board Standoffs Mountings

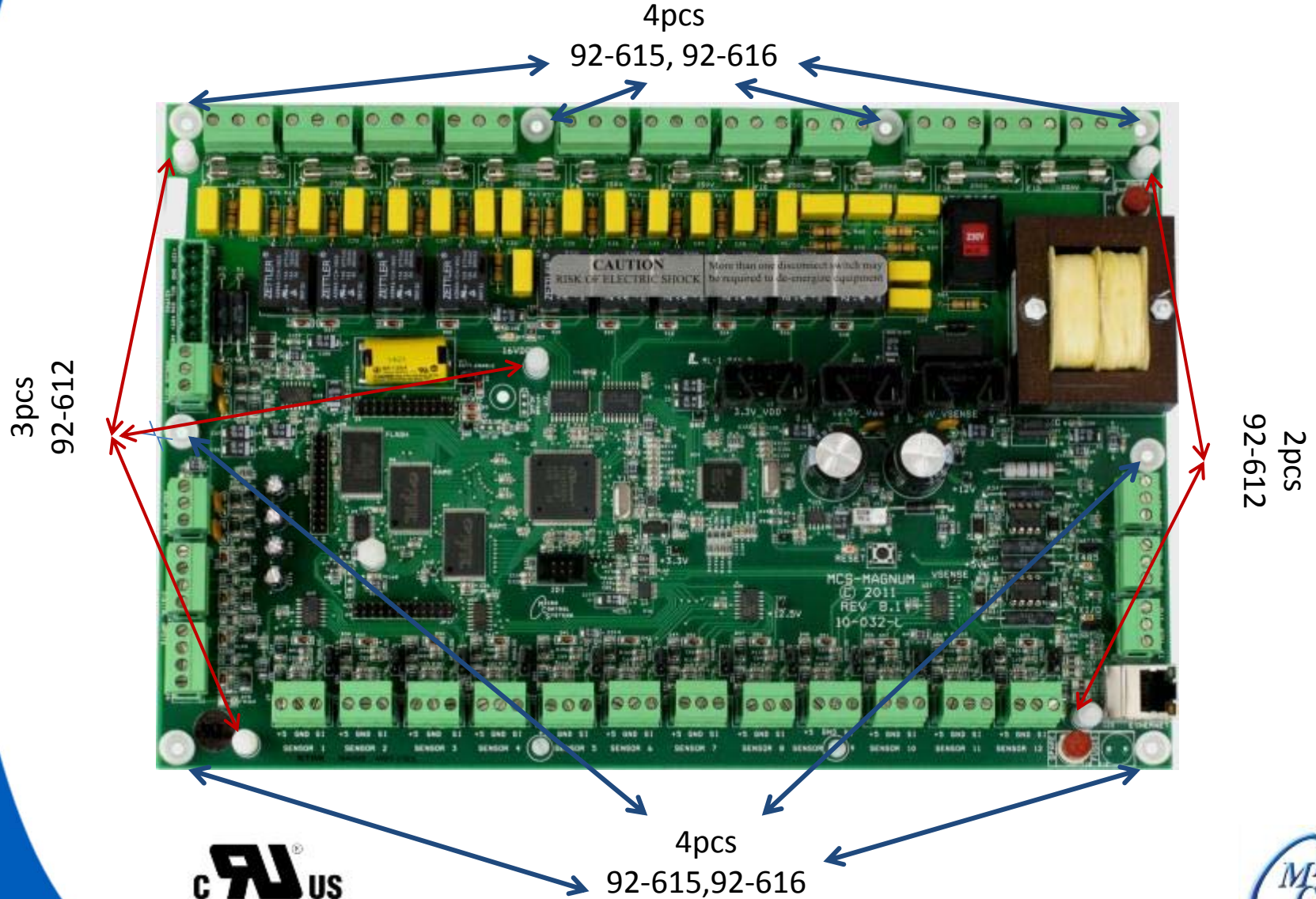

File No: E169780 (115vac & 24vac)



Magnum Board Jumpers

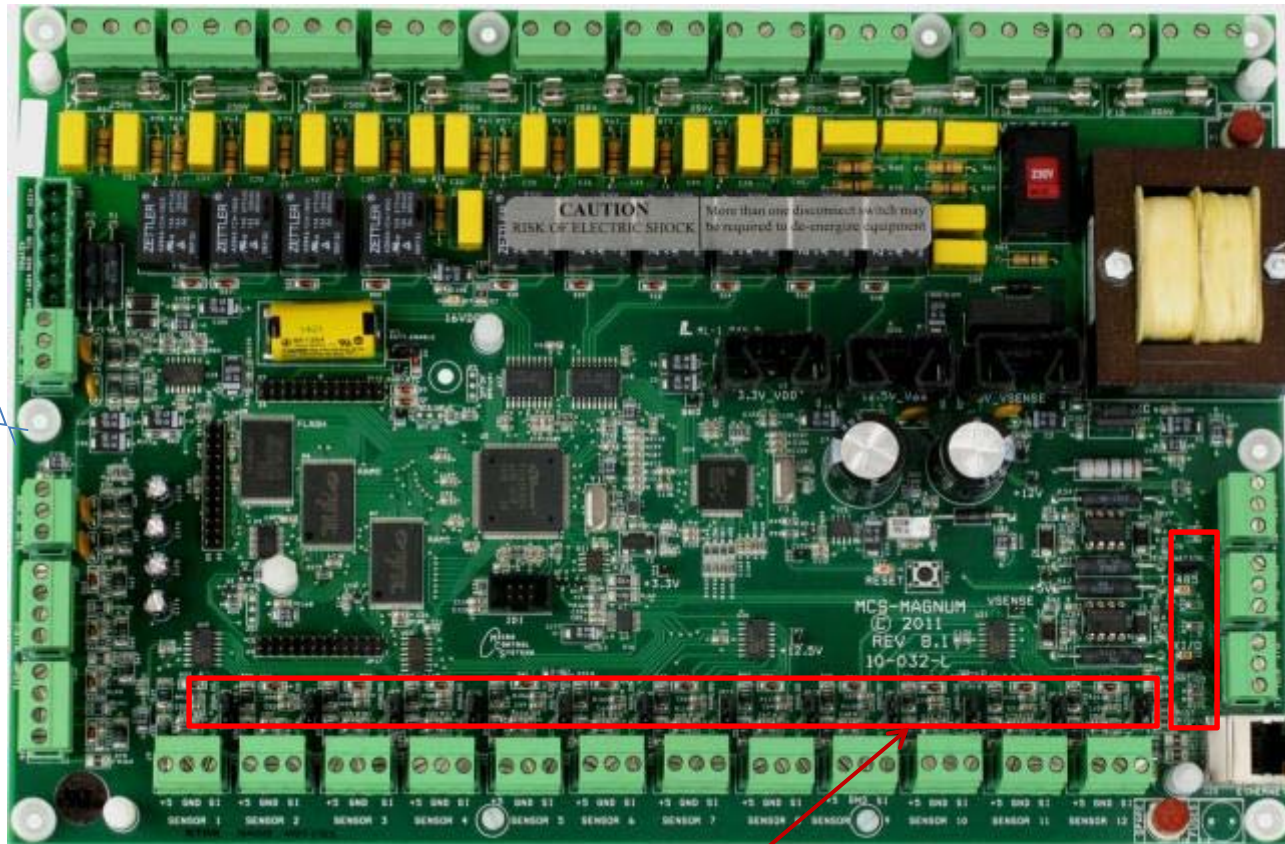

14pcs
40-022



File No: E169780 (115vac & 24vac)



MCS-R010 Terminal Blocks

6 pcs 41-036-3



5 pcs 41-036-3

1 pcs 41-038-3



File No: E169780 (115vac & 24vac)



MCS-R010 Board Fuses

5 pcs 25-011

1pcs 25-018 (120/240 vac)
1pcs 25-019 (24vac)

Spare
1pcs 25-018 (120/240 vac)
1pcs 25-019 (24vac)



5 pcs 25-011



File No: E169780 (115vac & 24vac)



MCS-RO10 Standoffs Mountings

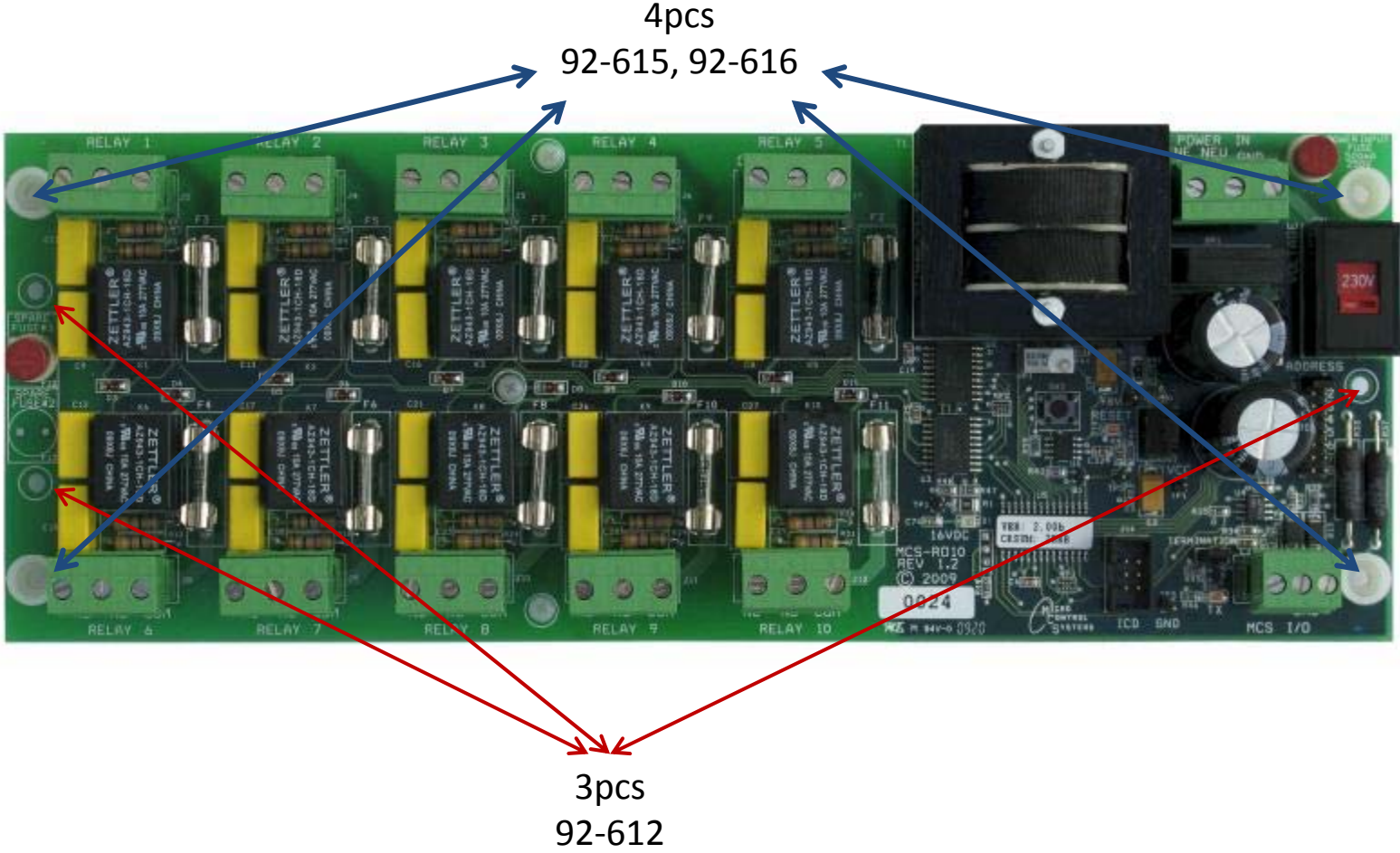

File No: E169780 (115vac & 24vac)



MCS-RO10 Jumpers



2pcs
40-022



File No: E169780 (115vac & 24vac)



MCS-SI16-AO4 Terminal Blocks

9pcs 41-038-3

1pcs 41-036-3



11pcs 41-038-3



File No: E169780 (115vac & 24vac)



MCS-SI16-A04 Board Fuses

1pcs 25-018 (120/240vac)
1pcs 25-019 (24vac)

Spare
1pcs 25-018 (120/240vac)
1pcs 25-019 (24vac)



File No: E169780 (115vac & 24vac)



MCS-SI16-A04 Board Mountings

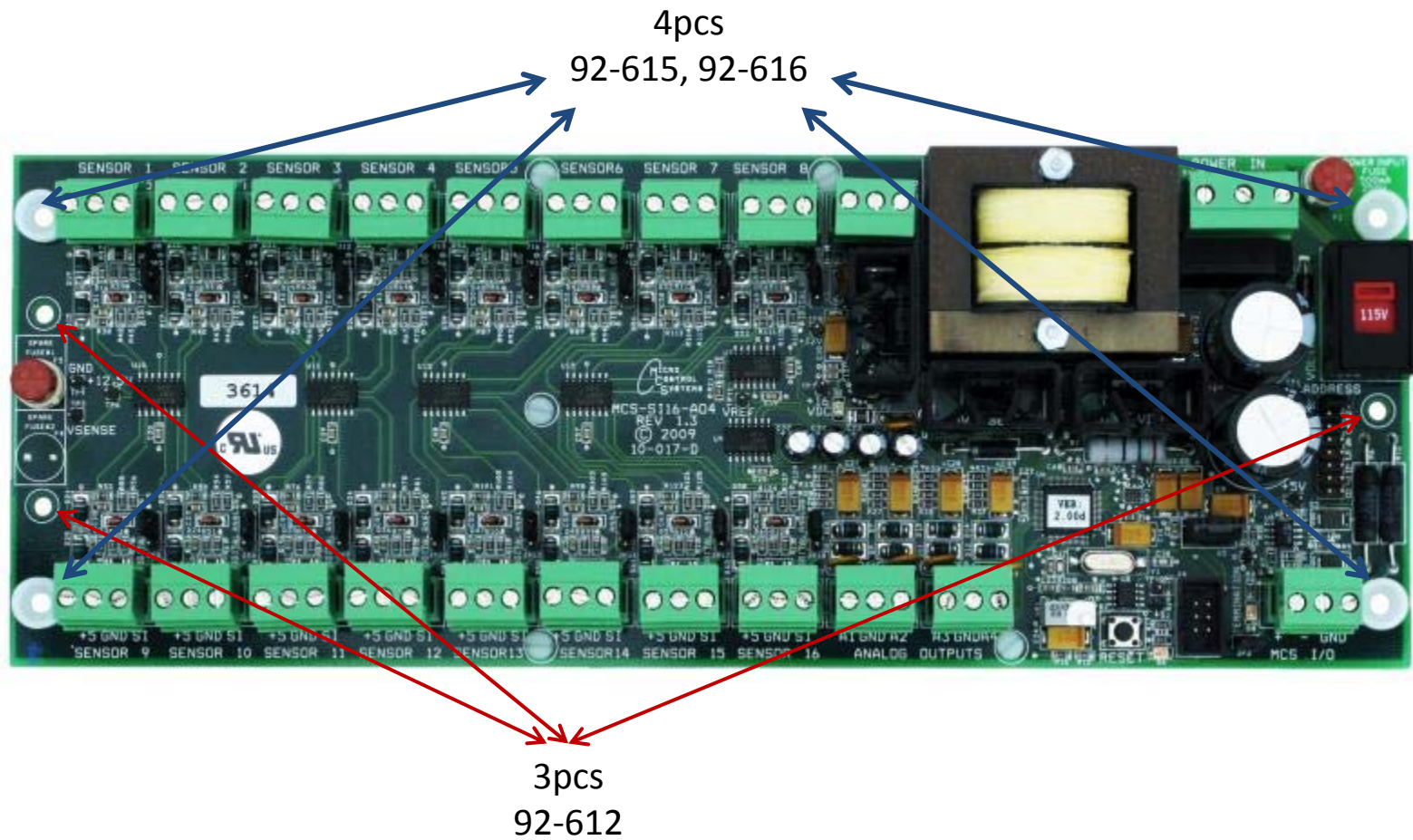

MCS-SI16-A04 Jumpers

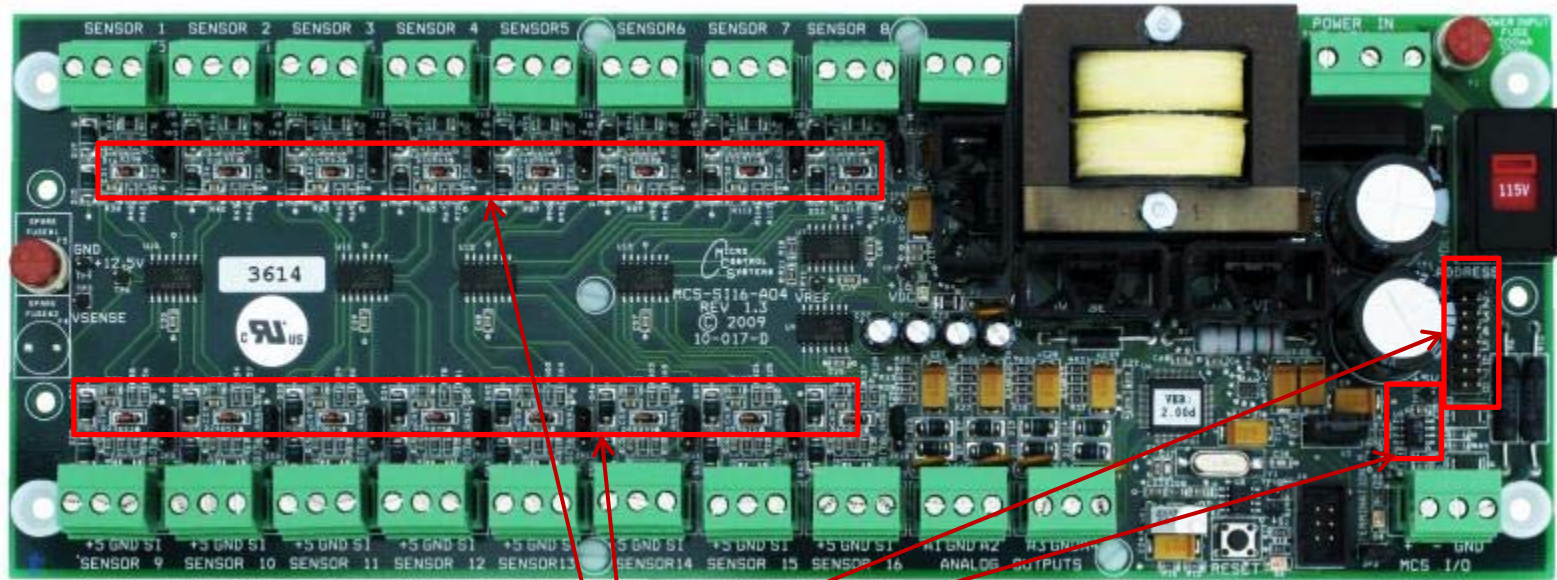

18pcs
40-022

MicroMag Terminal Blocks

3pcs 41-038-6

1pcs 41-038-3

1pcs
2pcs
4 - 41-038-3 4 - 41-038-4

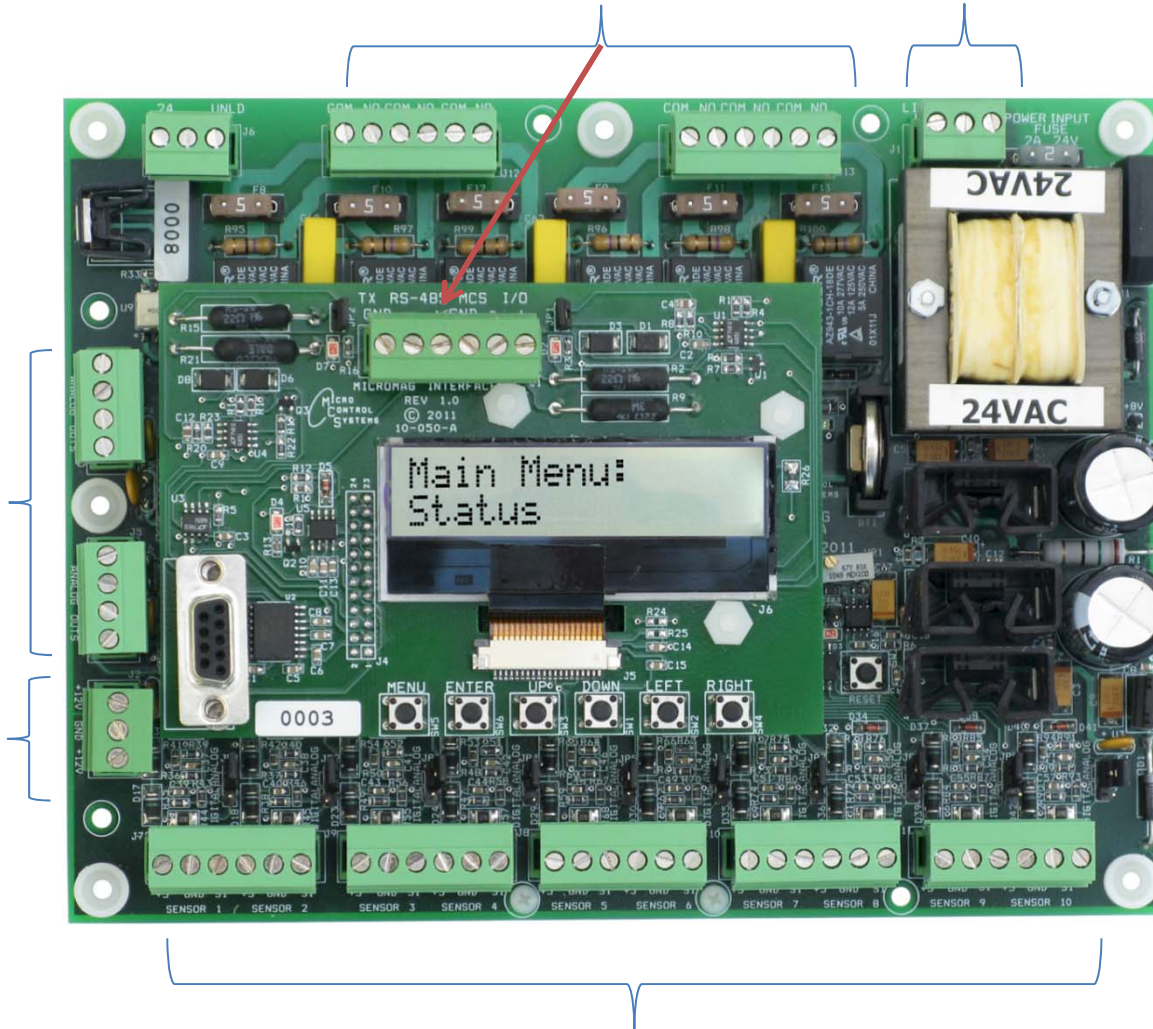

5pcs 41-038-6

MicroMag Board Fuses

6pcs 25-024

1pcs 25-023

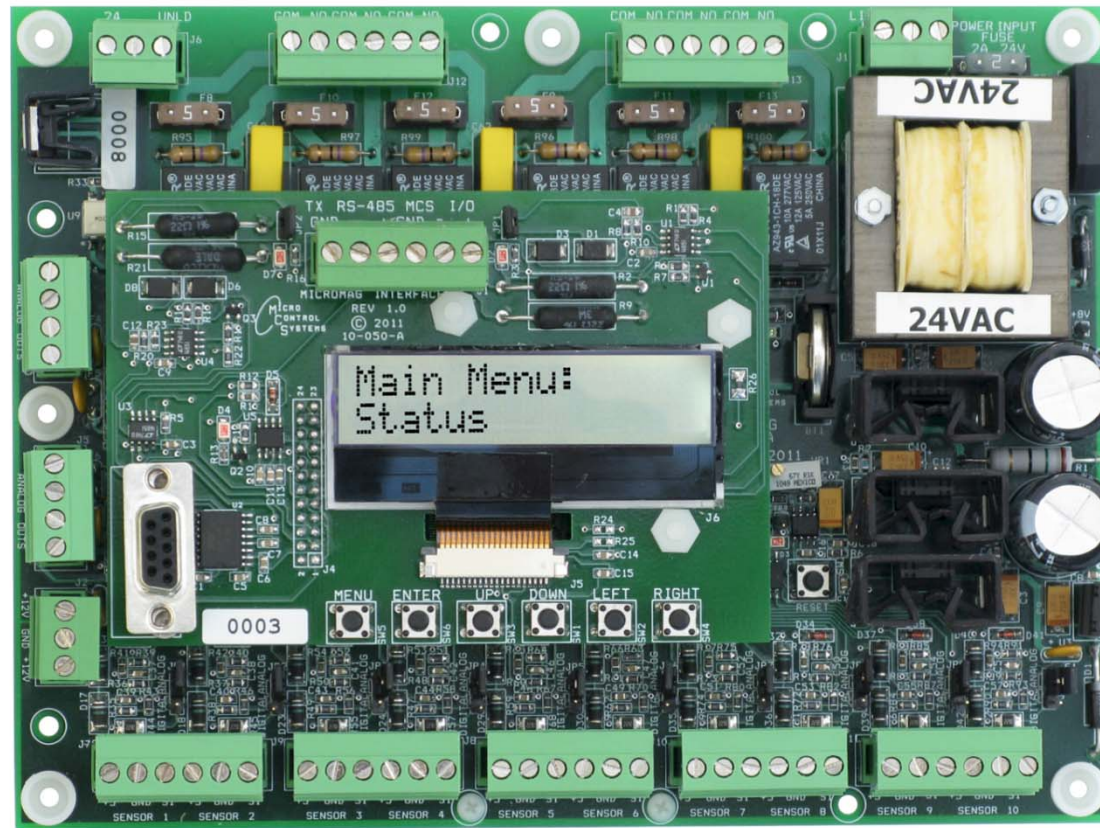

MicroMag Board Mountings

3pcs
92-615, 92-616

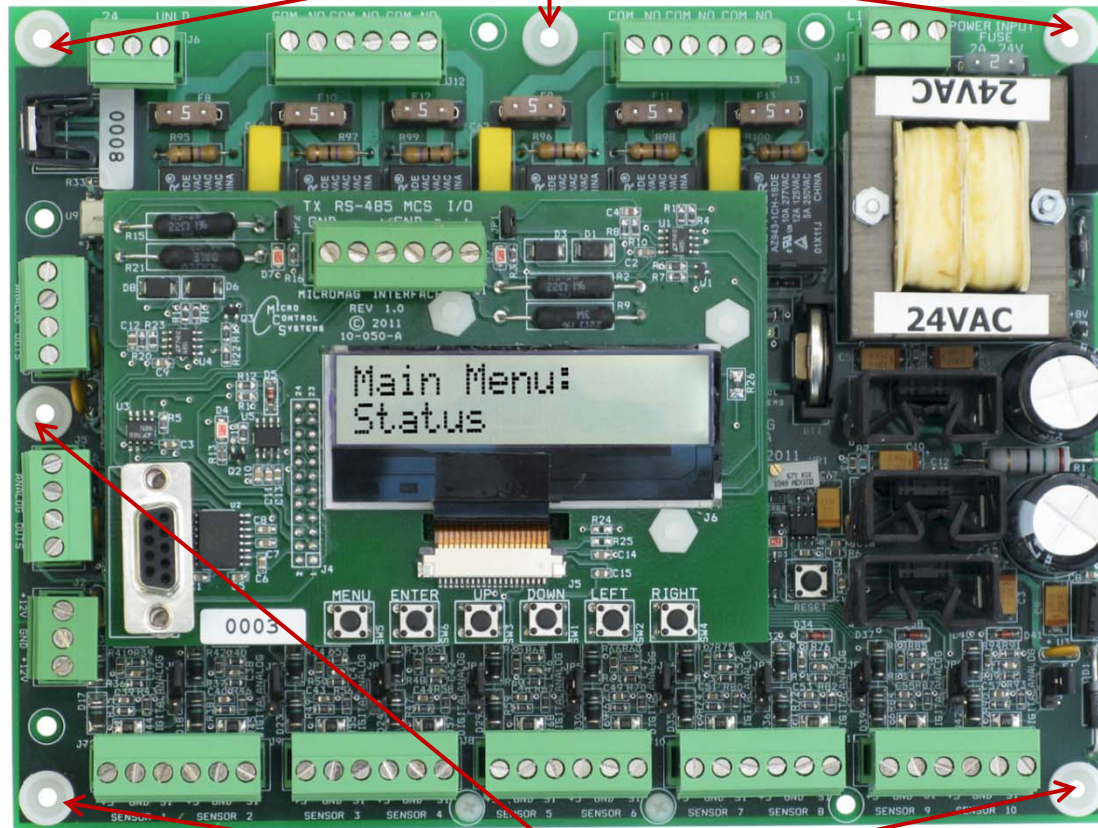

3pcs
92-615, 92-616

MicroMag Board Jumpers

2pcs
40-022

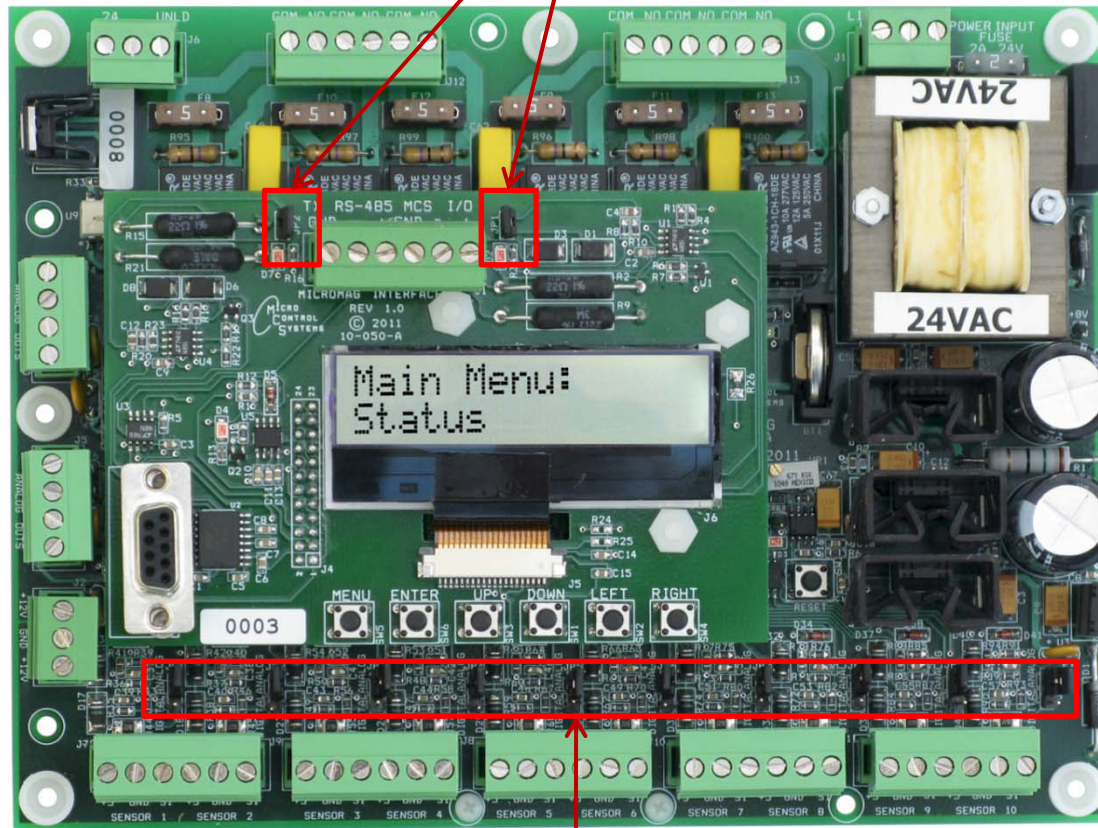

10pcs
40-022

MicroMag RO6 Terminal Blocks

1pcs 41-038-6

1pcs 41-038-3

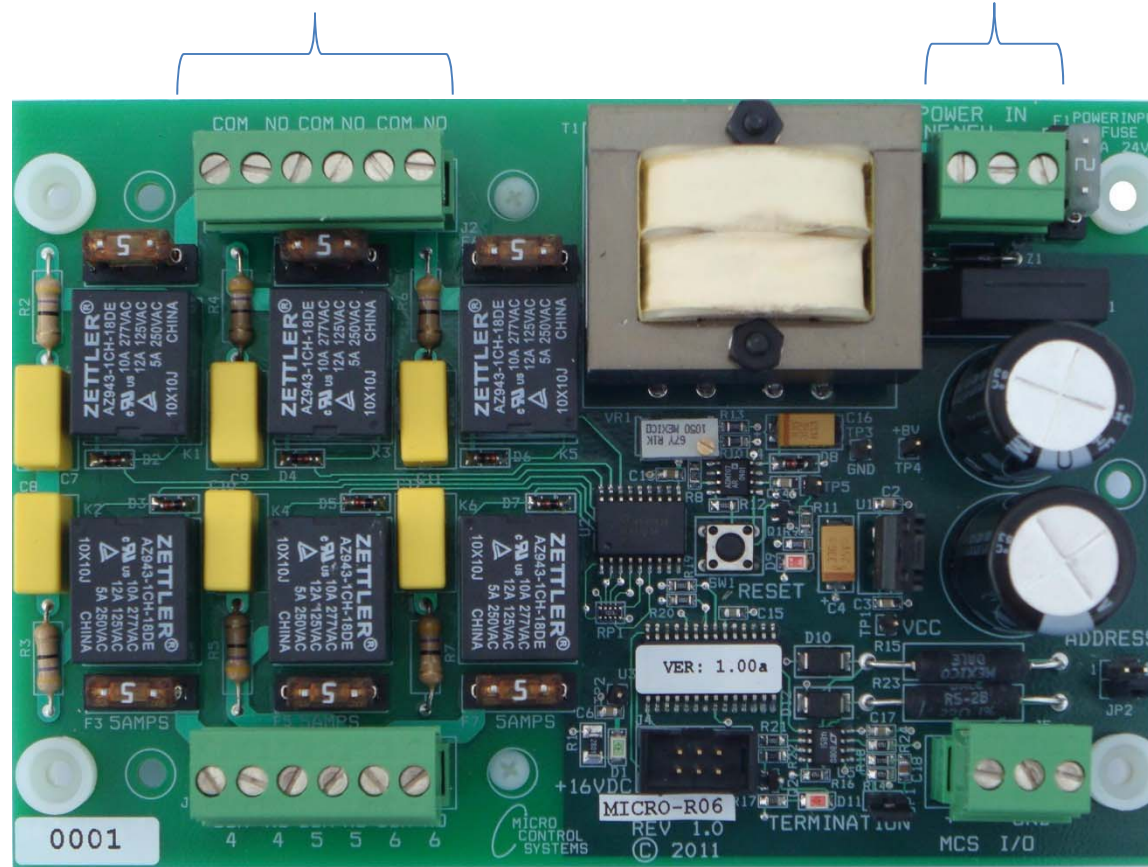

1pcs 41-038-6

1pcs 41-038-3

MicroMag R06 Board Fuses

3pcs 25-024

1pcs 25-023

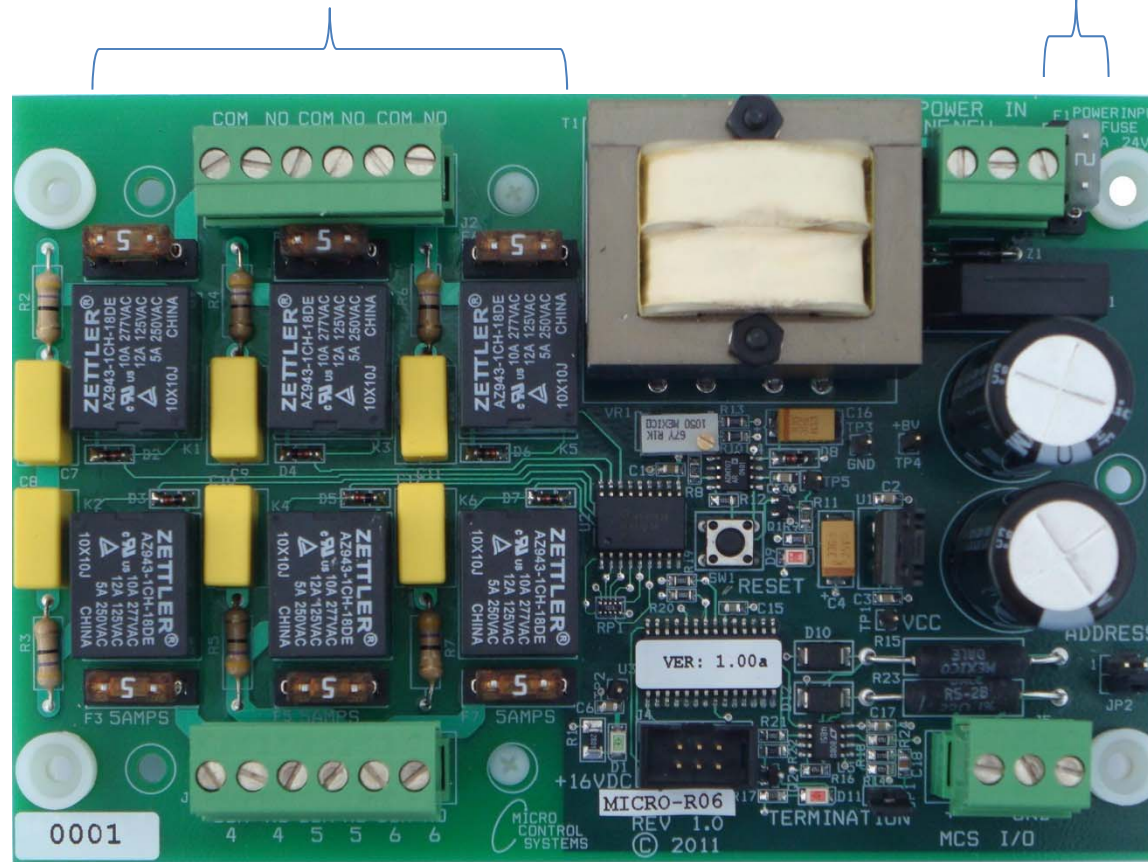

3pcs 25-024

MicroMag RO6 Mountings

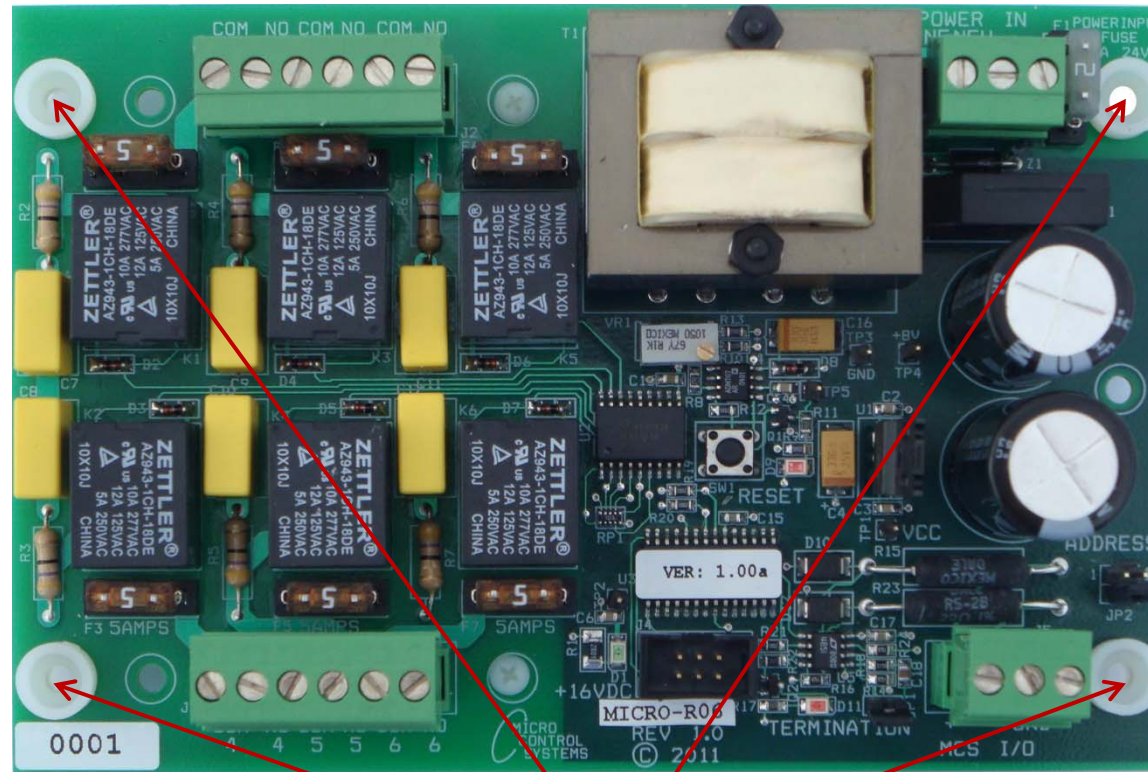

4pcs
92-615, 92-616

MicroMag RO6 Jumpers

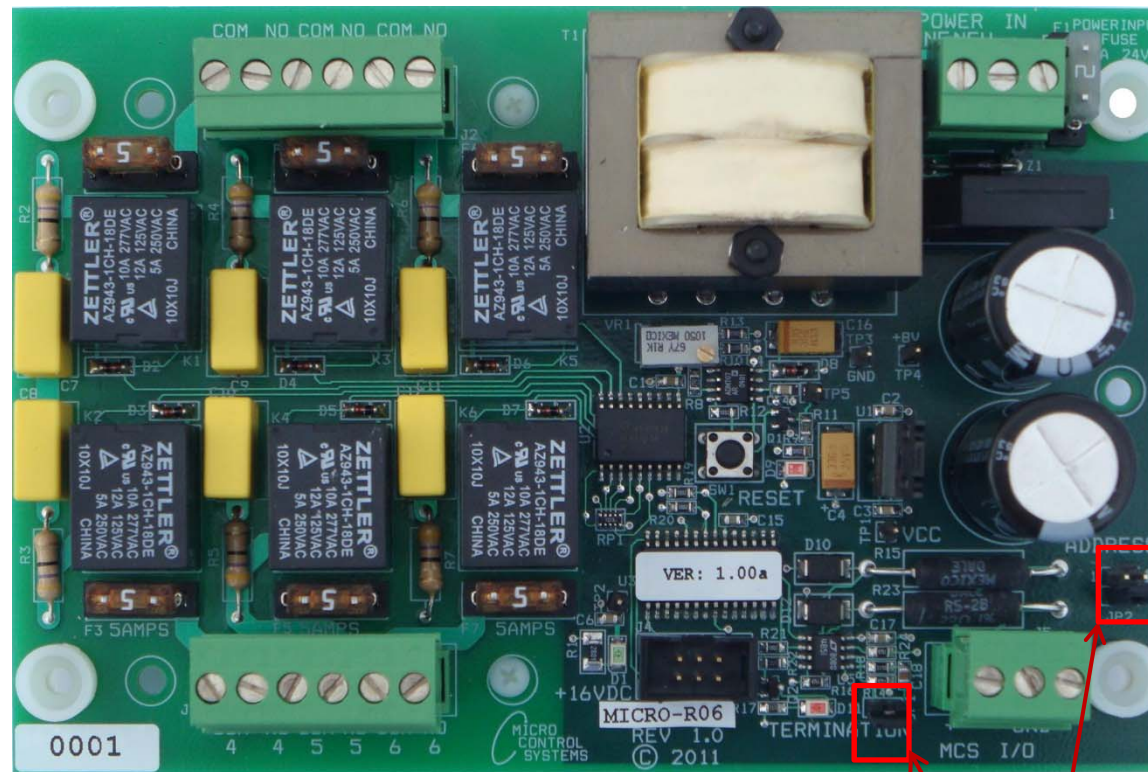

2pcs
40-022

MicroMag SI8-A04 Terminal Blocks

2pcs 41-038-6

1pcs 41-038-3

1pcs 41-038-3

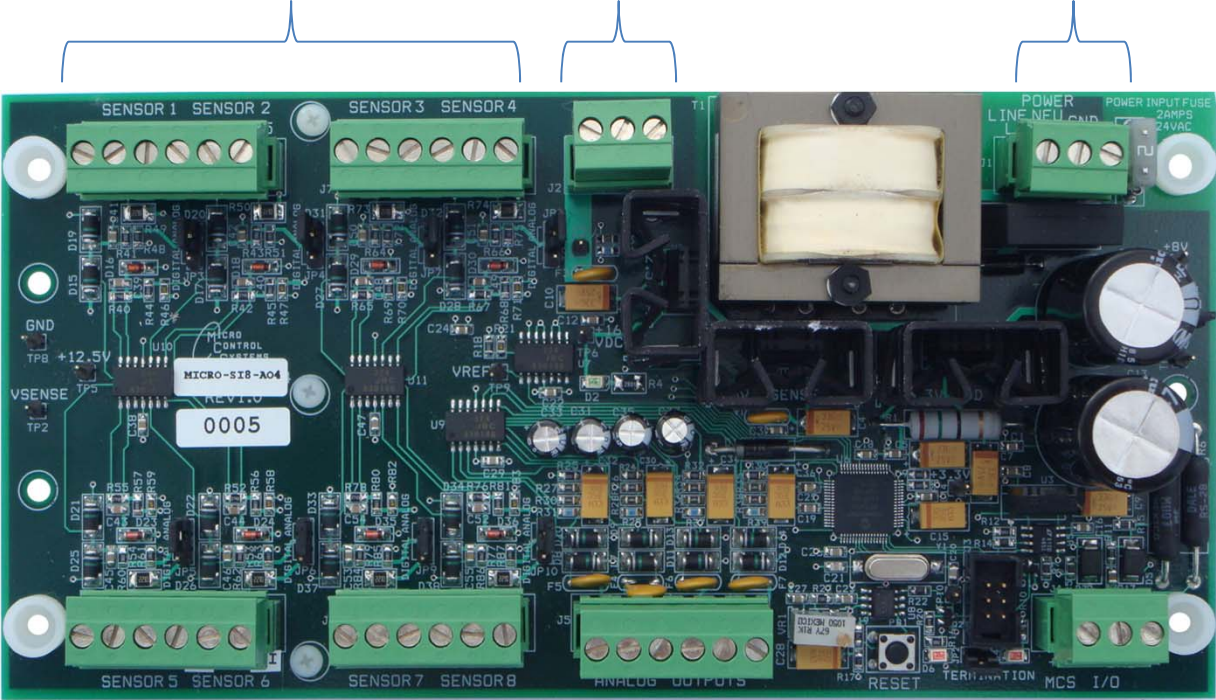

3pcs 41-038-6

1pcs 41-038-3

MicroMag SI8-A04 Board Fuses

1pcs 25-023

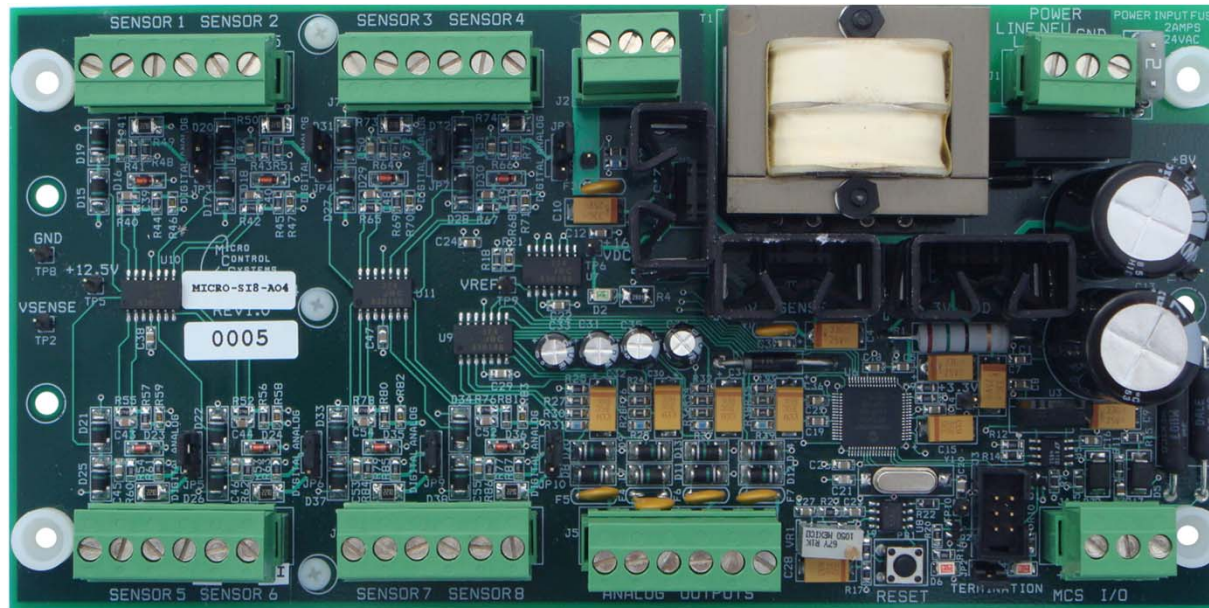

MicroMag SI8-A04 Board Mountings

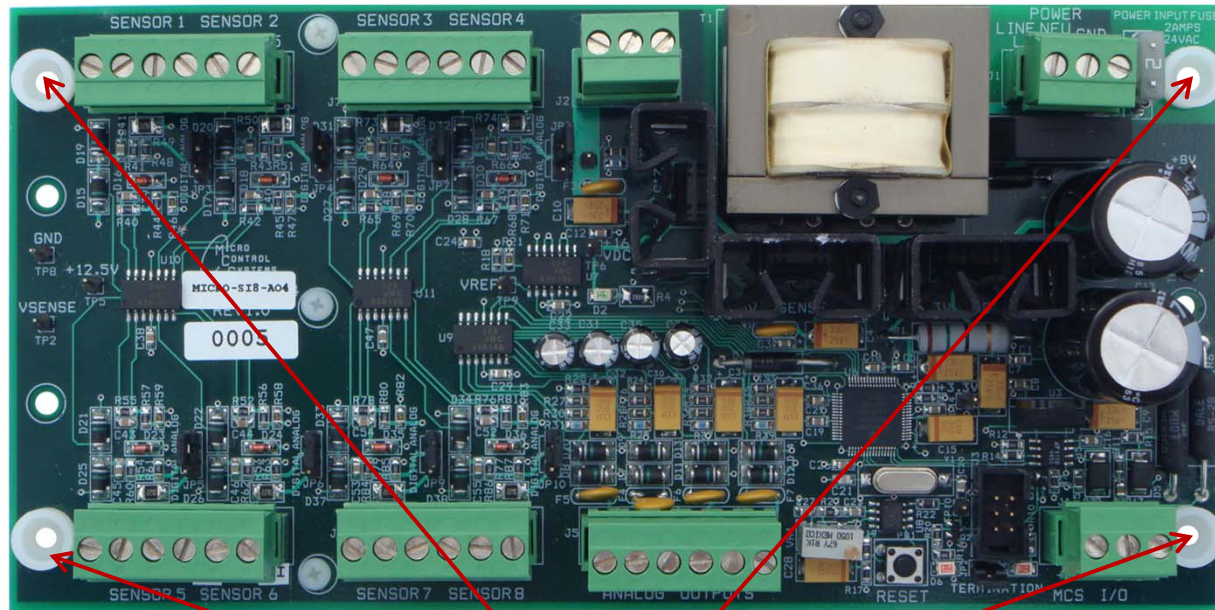

4pcs
92-615, 92-616

MicroMag SI8-A04 Jumpers

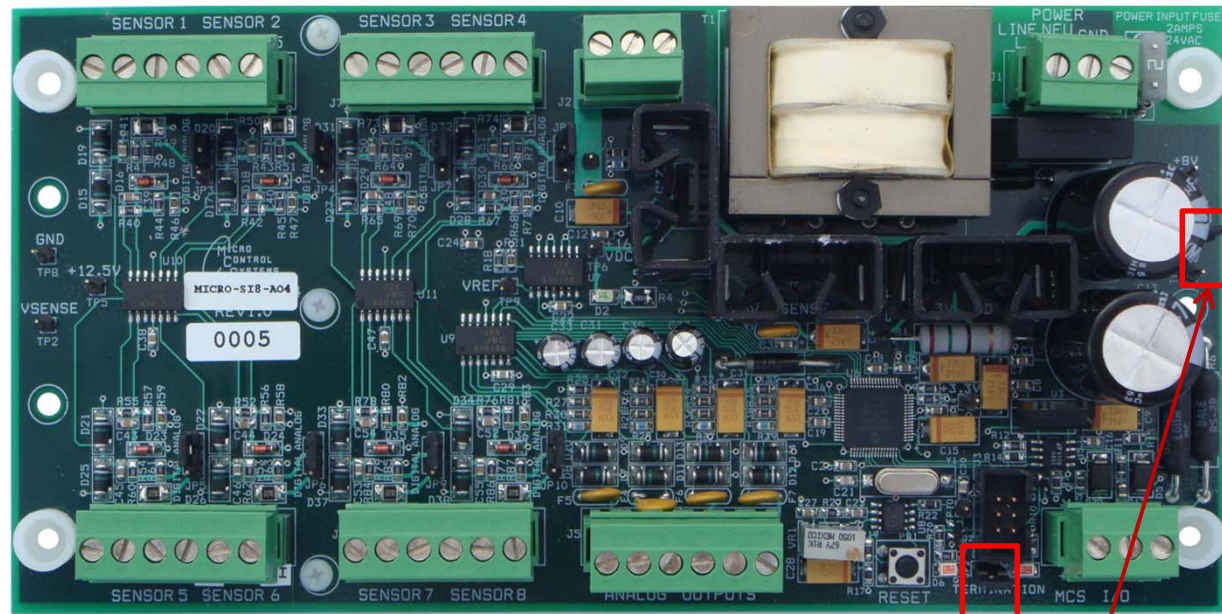

2pcs
40-022

MAGNUM/MicroMag Misc parts

MCS-PART #	LEXAN COVER	MOUNTING SCREWS
MAGNUM	14-036-1	(QTY=8) 92-023
RO10	14-034-1	(QTY=4) 92-023
SI16-A04	14-034-1	(QTY=4) 92-023
MicroMag	N/A	(QTY=6) 92-023
RO6	N/A	(QTY=4) 92-023
SI8-A04	N/A	(QTY=4) 92-023



MICRO CONTROL SYSTEMS

For additional information please contact
MCS or visit our website

www.mcscontrols.com

