



# MicroMag RTU Manual

Version 18  
Rev. 1.9 - 2023-07-20

5580 Enterprise Pkwy.  
Fort Myers, FL 33905

Office: 239-694-0089  
Fax: 239-694-0031

[www.mcscontrols.com](http://www.mcscontrols.com)



**MCS Total  
Solution  
for all your  
Control  
Needs**

The MicroMag is a rugged microprocessor based controller designed for the hostile environment of the HVAC/R industry. It is designed to be the primary manager of the package it is controlling.



**Energy Efficient and RoHS Compliant**

The MCS Commitment is to provide practical solutions for the industries needs and to be both a leader and partner in the effective use of microprocessor controls.

Micro Control Systems, Inc.  
5580 Enterprise Parkway  
Fort Myers, Florida 33905  
PH:(239) 694-0089 FAX:(239) 694-0031  
[www.mcscontrols.com](http://www.mcscontrols.com)

All information contained within this document is considered to be proprietary information of Micro Control Systems, Inc. No information or data from this document shall be published, used, reproduced, transmitted, or disclosed to others outside your organization without the prior expressed written consent of Micro Control Systems, Inc. This document and the information contained herein shall be treated as proprietary. Reasonable provisions shall be provided to ensure that this information remains proprietary by your employees, agents, and other personnel that may have access to this document.

Copyright ©2023

# Table of Contents

<b>Chapter - 1. MicroMag Hardware</b>	7
1.1. MicroMag - Hardware Rev. 7.0 and greater- Firmware V18.00 and up	7
1.2. MicroMag without Cover	8
1.3. MicroMag with Cover	8
1.4. MicroMag-12-Nema 4	8
<b>Chapter - 2. MicroMag Optional Expansion Boards</b>	9
2.1. MCS-SI-BASE and MCS-SI-EXT	9
2.2. MCS-RO-BASE and MCS-RO-EXT	9
2.3. MCS-IO-BASE and MCS-IO-EXT	10
<b>Chapter - 3. AUTHORIZATION FUNCTION</b>	11
3.1. Authorized via the Keypad/LCD	12
3.2. Authorized via MCS-CONNECT	12
<b>Chapter - 4. MicroMag Keypad</b>	13
4.1. Main Menu Status	13
4.2. Service Tools	14
4.3. Viewing Alarms And Events	18
4.4. Lockout - Clear	18
4.5. Changing Values of a Setpoint	19
4.6. Viewing the Current Status of the Unit	20
4.6.1. DEFAULT LCD DISPLAY	20
<b>Chapter - 5. MicroMag Communications Options</b>	21
5.1. MicroMag's using MCS-CONNECT - MCS-USB-RS485	21
5.2. Multiple MicroMag's using MCS-CONNECT - RS485 and MCS-Touchscreen	22
5.3. Multiple MicroMag's, over Internet using MCS-Connect & MCS-ETHERNET-RS485	23
<b>Chapter - 6. MCS-CONNECT Software Support</b>	24
<b>Chapter - 7. MCS-CONNECT Screens</b>	25
7.1. RTU STATUS	25
7.2. RTU RELAY OUTPUTS	26
7.3. RTU ANALOG OUTPUTS	26
7.4. RTU SENSOR INPUTS	27
7.5. RTU CONTROL STATES	28
7.6. RTU RESET/CLEAR	30
7.7. RTU ALARMS	30
7.8. List of Alarms Generated by MicroMag	31
7.9. RTU SCHEDULES	32
7.10. RTU INFORMATION SCREEN	32
<b>Chapter - 8. EXV Control</b>	33
8.1. EXV STATES	33
8.2. EXV LOGIC	34
8.2.1. EXV TARGET (Setpoint #132)	34
8.2.2. EXV ADJUST (Delay) (Setpoint #133)	34
8.2.3. EXV LOW SUPERHEAT (Time) (Setpoint #134)	34
8.2.4. EXV MOP (Maximum operating pressure) TARGET (Setpoint #135)	34
<b>Chapter - 9. MCS-CONNECT - GRAPHICS</b>	35
9.1. Graphics Screen	35
9.2. Changing the Graphics	36
9.2.1. Graphics File Update	37
<b>Chapter - 10. ALARMS</b>	38
<b>Chapter - 11. Graph Capabilities of MicroMag and MCS-CONNECT</b>	40
11.1. Graph Setup Tabs	42
11.1.1. Graph Setup Button	42
11.1.1.1. Interval and Y AXIS SETUP	42

11.1.2	Refresh Data Button .....	43
11.1.3	Save History Button .....	43
11.1.4	Print Graph .....	43
<b>Chapter - 12.</b>	<b>Diagnostic Save ‘EASY BUTTON’ .....</b>	<b>44</b>
12.1.	Diagnostic Save.....	44
<b>Chapter - 13.</b>	<b>MCS-RTU MODES OF OPERATIONS .....</b>	<b>45</b>
13.1.	MicroMag Scheduling.....	45
13.2.	MicroMag Occupied Mode.....	45
13.3.	MicroMag Unoccupied Mode.....	45
13.4.	MicroMag Ventilation Mode .....	46
13.5.	MicroMag OFF Mode.....	46
13.6.	MicroMag Proof of Flow.....	46
13.7.	MicroMag Dirty Filter Status .....	46
13.8.	MicroMag Smoke Detector .....	46
13.9.	MicroMag Air to Air Heat Pump Operation.....	47
13.10.	MicroMag Warning Notification.....	47
13.11.	MicroMag Alarm Notification.....	47
13.12.	MicroMag Lockout Alarm Information.....	48
13.13.	MicroMag Zone Temperature/Humidity Mode .....	48
13.14.	MicroMag Duct Static Pressure Control .....	48
13.15.	MicroMag BMS Support .....	48
13.16.	MicroMag Keypad/Display.....	49
13.17.	MicroMag Data Trending .....	49
13.18.	MicroMag Cooling Mode.....	49
13.19.	MicroMag Heating Mode .....	50
13.20.	MicroMag Dehumidification Mode .....	50
<b>Chapter - 14.</b>	<b>MCS-CONFIG .....</b>	<b>51</b>
14.1.	General Options .....	51
14.1.1	DEFAULT LCD DISPLAY .....	52
14.1.2	SETUP EXPANSION BOARDS / THERMOSTAT.....	52
14.1.3	DAYLIGHT SAVING TIME .....	52
14.2.	MicroMag MCS-Config .....	53
14.2.1	General Info .....	53
14.2.2	Ventilation Info .....	54
14.2.3	Cooling Info.....	55
14.2.4	Heating Info .....	56
<b>Chapter - 15.</b>	<b>CONTROL OPERATIONS .....</b>	<b>57</b>
15.1.	Control Modes .....	57
15.2.	Power up .....	57
15.3.	Determine Building mode .....	57
15.3.1	From MicroMag Display:.....	57
15.3.2	From your laptop using MCS-CONNECT: .....	57
15.4.	Determine Unit mode.....	57
15.4.1	OFF.....	57
15.4.2	Cooling Mode.....	57
15.4.3	Heating Mode .....	58
15.4.4	Vent Mode.....	58
15.4.5	Dehumidification Mode .....	58
15.5.	Combustion Module Control.....	58
15.5.1	Ignition .....	59
15.5.2	Warm up .....	59
15.5.3	Heating .....	59
15.6.	Override Button .....	59
15.7.	Resets .....	59
15.7.1	MAX RESET (Setpoint #99).....	59
15.7.2	MAX CALC RESET (Setpoint #109).....	59
15.7.3	USER RESET (Setpoint #110).....	59

15.8.	Modbus RTU .....	59
15.9.	Network inputs to MicroMag .....	60
15.10.	MicroMag BMS protocols settings .....	60
15.11.	Modbus RTU .....	60
<b>Chapter - 16.</b>	<b>MicroMag States .....</b>	<b>61</b>
16.1.	Economizer States .....	61
16.2.	Evaporator Fan State .....	61
16.3.	Pump States .....	62
16.4.	Cooling States .....	62
16.5.	Condenser States .....	63
16.6.	Heating States .....	63
16.7.	Reheat States .....	64
16.8.	Exhaust States .....	64
16.9.	RTU Algo States .....	65
16.10.	Chiller States .....	65
16.11.	Compressor States .....	66
<b>Chapter - 17.</b>	<b>BMS COMMUNICATION .....</b>	<b>67</b>
17.1.	BACnet Properties .....	67
17.2.	MICROMAG PROTOCOLS .....	67
17.2.1	BACNET PROTOCOL DEVICE ID .....	68
17.2.2	Network inputs to MicroMag .....	68
17.3.	BMS Sensor Input Points .....	69
17.4.	BMS Relay Output Points .....	70
17.5.	BMS Analog Output Points .....	71
17.6.	BACnet MS/TP BMS Setpoints .....	72
17.7.	BACnet MS/TP Unit Control Information .....	76
17.8.	BACnet Compressor States .....	77
17.9.	BMS Writable Network Points Information .....	79
17.10.	BMS Points Writable Setpoint Points Grid Information .....	79
17.11.	BMS SI Information .....	79
17.12.	BMS RO Information - MCS-BMS-GATEWAY .....	80
17.13.	BMS AO Information - MCS-BMS-GATEWAY .....	81
17.14.	BMS Unit Control - MCS-BMS-GATEWAY .....	81
17.15.	BMS Compressor/Condenser Points - MCS-BMS-GATEWAY .....	82
17.16.	Writeable Network Points- MCS-BMS-GATEWAY .....	84
<b>Chapter - 18.</b>	<b>BMS STATE LIST .....</b>	<b>85</b>
18.1.	CHILLER_ALGO_STATE_LIST .....	85
18.2.	BACNET_MSV_OCCUPATION_MODE MSV:1 .....	85
18.3.	BACNET_MSV_NETWORK_RUN_STOP MSV:2 .....	86
18.4.	BACNET_MSV_EVAPORATOR_STATE MSV:10 .....	86
18.5.	BACNET_MSV_COOLING / PRECOOLING STATES .....	87
18.6.	COMPRESSOR STATES .....	88
18.7.	CONDENSER STATES .....	89
18.8.	HEATING / IGNITION STATES - RTU ONLY .....	90
18.9.	REHEAT STATE - RTU ONLY .....	91
18.10.	ECONOMIZER STATE .....	91
18.11.	EXHAUST STATE .....	92
18.12.	EXV STATES .....	93
<b>Chapter - 19.</b>	<b>BMS COMMUNICATION PROTOCOLS .....</b>	<b>94</b>
18.13.	Reading Alarm Points For MicroMag .....	94
<b>Chapter - 20.</b>	<b>MICROMAG BMS ALARMS .....</b>	<b>96</b>
20.1.	MICROMAG ALARMS DETAILS REFERENCE NUMBERS .....	98
<b>Chapter - 21.</b>	<b>TROUBLESHOOTING QUICK REFERENCE .....</b>	<b>107</b>
<b>Chapter - 22.</b>	<b>MicroMag RTU Setpoints .....</b>	<b>109</b>
22.1.	Setpoint Types .....	110
22.1.1	SETPOINT .....	110

22.1.2	LOCKOUT.....	110
22.1.3	ALARM.....	110
22.1.4	Time.....	111
22.1.5	Target.....	111
22.1.6	Delay.....	111
22.1.7	Minimum Capacity .....	111
22.1.8	Warning.....	112
22.1.9	Enable.....	112
22.2.	Window/Safety extension .....	112
22.2.1	Time and seconds to ignore for setpoints.....	112
<b>Chapter - 23.</b>	<b>Displaying Setpoints</b> .....	<b>113</b>
23.1.	Keypad/Display.....	113
23.2.	MCS-CONNECT.....	113
23.3.	CALCULATION MADE IN SETPOINTS IN MICROMAG FIRMWARE .....	114
23.4.	RTU SETPOINTS.....	115
<b>Chapter - 24.</b>	<b>COOLING SETPOINTS</b> .....	<b>143</b>
24.1.	List of Cooling setpoints .....	143
<b>Chapter - 25.</b>	<b>HEATING, REHEAT &amp; CONDENSER SETPOINTS</b> .....	<b>145</b>
25.1.	List of SETPOINTS.....	145
25.2.	Revision Page .....	146

# Chapter - 1. MicroMag Hardware

The MicroMag is available as 12vdc system supported by a MCS-RO-Base, MCS-RO-Ext, MCS-SI-Base, MCS-SI-Ext expansion boards The system can support the following:

- Triac Output for a Digital Scroll
- up to 42 Sensor Inputs either Analog or Digital
- Up to 26 Relay Outputs fused at 5 Amps
- Up to 12 Analog Outputs (0/10 VDC or 10/0 VDC)

## 1.1. MicroMag - Hardware Rev. 7.0 and greater- Firmware V18.00 and up

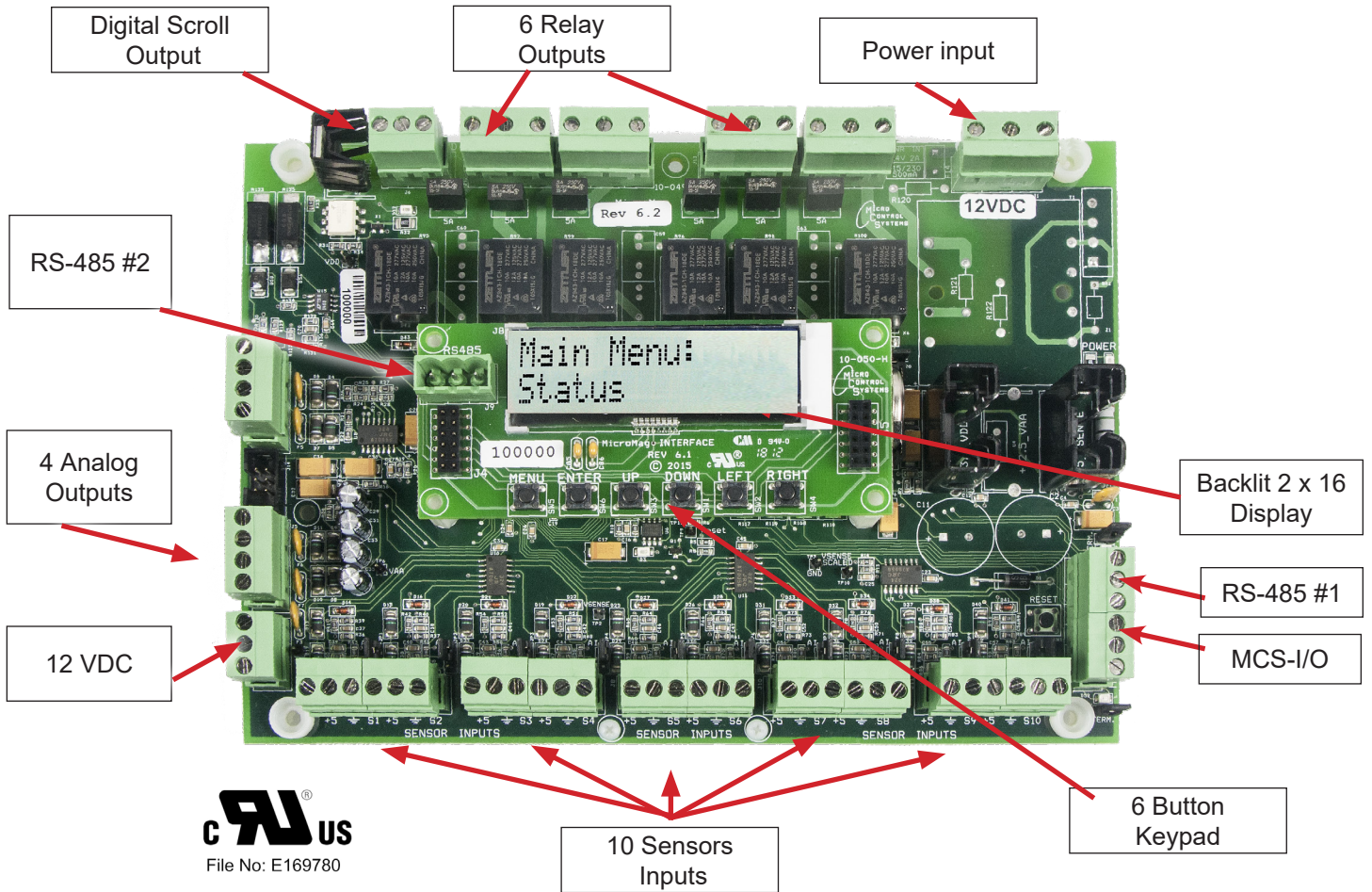

- Four Layer Printed Circuit Board with Power & Ground Plane for Noise Protection
- Six Relay Outputs, Fused @ 5 amps, Common & Normally Open Terminals Provided
- Ten Sensor Inputs (Analog or Digital) +5 VDC Power, Polyfuse Protected
- Four Analog Outputs provided, 0 to 10 VDC or 10 to 0 VDC, Polyfuse Protected
- +12 VDC provided for sensors where required, Polyfuse Protected
- Two RS 485 ports for BACnet MSTP or Modbus RTU built in Communications
- MCS-I/O communications port to communicate to other I/O boards on this system
- A built in Boot Loader that allows MCS-CONNECT to load Firmware and Config's
- Program Flash = 512K, Aux Flash = 24K, Ram = 52K, DMA Ram = 4K, E<sup>2</sup> = 64K

## 1.2. MicroMag without Cover

Rev. 6.1 - available 12vdc

8.50”l, 6.00”w, 2.10”h

Operating Temp. .... -4°F to +158°F (-20°C to +70°C)  
 Sensor Inputs (SI)..... 10 inputs 0-5vdc (10-bit A/D)  
 Relay Outputs (RO) .... 6 outputs 5. 0amps @ 24 vac  
 Analog Outputs (AO) .. 4 outputs 0-10vdc  
 MCS-I/O Comm Port... 1 @ 38,400 baud  
 RS-485 Comm Port .... 2 @ 19,200 to 115,200 baud  
 Real Time Clock..... Battery backed  
 Input power ..... 12vdc  
 Power Detection ..... Automatic power fail reset  
 Keypad/LCD  
 Display ..... 2 x 16 Backlit on I<sup>2</sup>C Bus  
 Keypad Layout..... 6 keys (Menu, Enter, 4 direction)

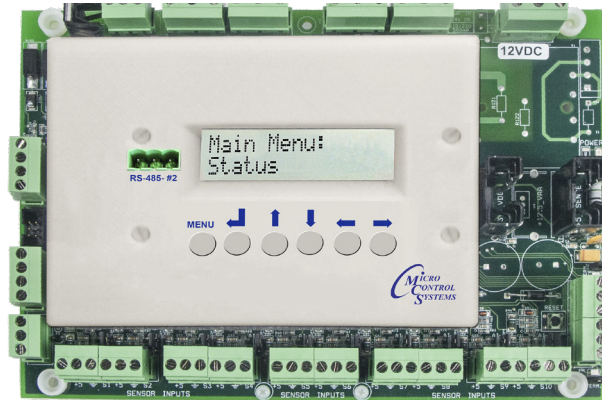
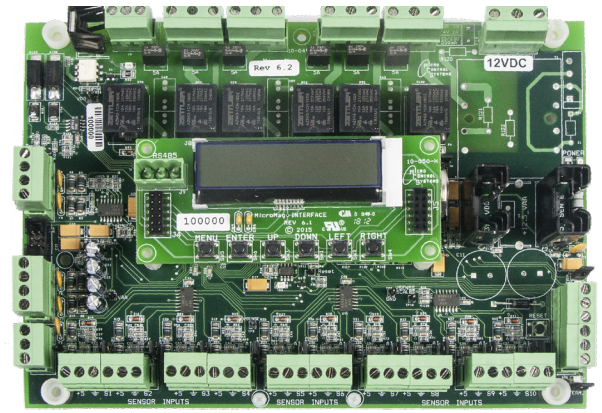

## 1.3. MicroMag with Cover

Comes with a Cover as shown in the photo on right. The cover is designed to mount on front of the circuit board or it can be mounted on the faceplate of your enclosure as shown below.



## 1.4. MicroMag-12-Nema 4

The MicroMag-12-NEMA4 is suitable for installation, both indoor and outdoor. Utilizing a gasket for an environment seal provides the unit with a NEMA 4 rating if installed in a NEMA4 enclosure.





# Chapter - 2. MicroMag Optional Expansion Boards

## 2.1. MCS-SI-BASE and MCS-SI-EXT

The MCS-SI-BASE provides a flexible and cost effective way to allow sensor input and analog output expansion for the MicroMag. Each MCS-SI-BASE has a stand-alone microprocessor which communicates with the MicroMag over the MCS-I/O port at 38,400 baud. Because communication is over a RS-485 long distance two-wire differential network transmission system, the MCS-SI-BASE may be located up to 5,000 feet away. The MCS-SI-BASE board is powered by a 12VDC regulated power supply and has a automatic power fail reset system.

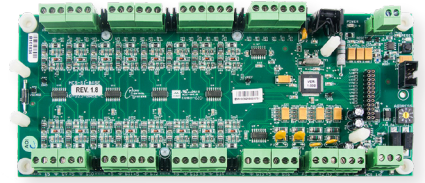

### MCS-SI-EXT

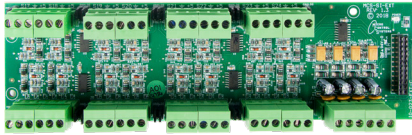

MCS-SI-EXT can be paired with a MCS-SI-BASE to double the number of inputs and outputs. MCS-SI-EXT board is powered by the MCS-SI-BASE board once it is stacked on top.

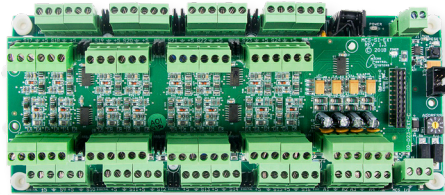

MCS-SI-EXT mounted to MCS-SI-BASE

## 2.2. MCS-RO-BASE and MCS-RO-EXT

The MCS-RO-BASE allows relay output expansion for the MicroMag. Each MCS-RO-BASE has a stand-alone microprocessor which communicates with a MicroMag over the MCS-I/O port at 38,400 baud. The MCS-RO-BASE board is powered by a 12VDC regulated power supply.

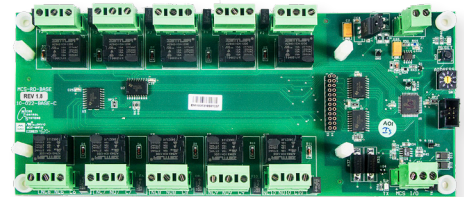

### MCS-RO-EXT

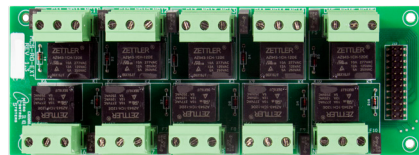

MCS-RO-EXT can be paired with a MCS-RO-BASE to double the number of inputs and outputs. MCS-SI-EXT board is powered by the MCS-RO-BASE board once it is stacked on top

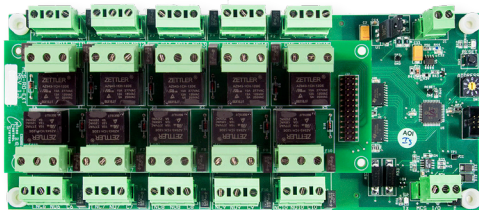

MCS-RO-EXT mounted to MCS-RO-BASE



### 2.3. MCS-IO-BASE and MCS-IO-EXT

The MCS-IO-BASE can provide sixteen extra sensors inputs, 10 relay outputs and four additional analog outputs that provide independent DC voltage outputs from 0 to 10vdc. These analog outputs are controlled by the Micromag.

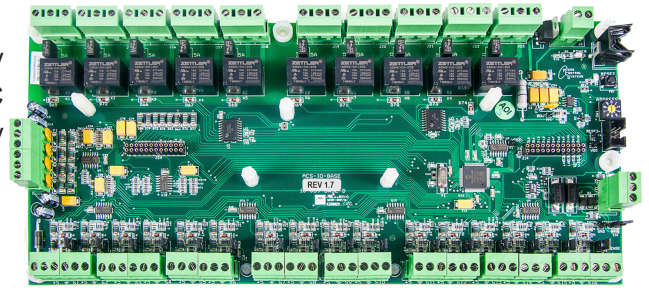

#### MCS-IO-EXT

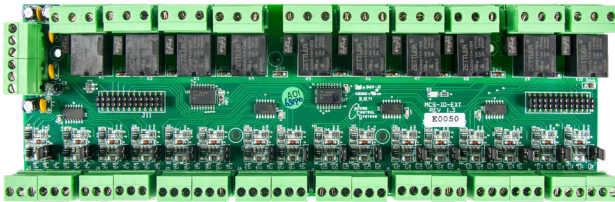

The MCS-IO-BASE allows one optional MCS-IO-EXT board to be stacked on top by using a board stacker header. Doing so will expand the number of sensors from 16 to 32, the number of analog outputs from 4 to 8, and the number of relays from 10 to 20 allowing twice the number of sensors, analog outputs, and relay outputs in the same footprint of one MCS-IO-BASE.

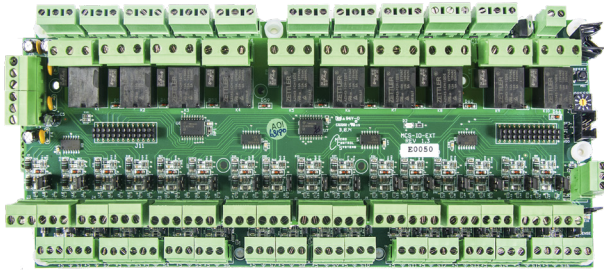

MCS-IO-EXT mounted to MCS-IO-BASE



## Chapter - 3. AUTHORIZATION FUNCTION

The authorization code is a special four-character code that enables access to the MicroMag controller. The code may consist of any valid alpha/numeric characters if the system is being accessed through MCS-CONNECT, however, the code must be numeric with values between 0 and 9 if it is to be entered through the Keypad/Display. Each MicroMag can have up to 10 different authorization codes, with four levels of authorization which provide differing levels of functionality. The authorization code and the associated level cannot be viewed or changed through the Keypad/Display or MCS-CONNECT, but only when the configuration file is opened in MCS-Config. The authorization codes should be protected and remain confidential, or unauthorized personnel may gain access to the system and perhaps cause irreparable damage.

Based upon the authorization level the following changes can be made through the Keypad/Display:

FUNCTION	VIEW	USER	SERVICE	SUPERVISOR	FACTORY	ADMIN
Sensor offsets	NO	NO	NO	YES	YES	YES
Clear alarm history	NO	NO	NO	NO	NO	YES
Clear point information	NO	NO	NO	NO	NO	YES
Date and time set	NO	NO	YES	YES	YES	YES
Day of week set	NO	NO	YES	YES	YES	YES
Change rotate SP 37 & 38	NO	NO	YES	YES	YES	YES
Change Manual/Auto settings	NO	NO	NO	YES	YES	YES
Change Setpoint values	*	*	*	*	YES	YES
Change operating schedules	NO	YES	YES	YES	YES	YES
Change holiday dates	NO	YES	YES	YES	YES	YES
Lockout Reset	**	**	**	**	YES	YES
Change RS485 network settings	NO	NO	NO	YES	YES	YES
Change Ethernet network settings	NO	YES	YES	YES	YES	YES
Transmit Software	NO	YES	YES	YES	YES	YES
Transmit/Receive Configuration	NO	NO	YES	YES	YES	YES

\* Setpoints may have individual authorization levels; you must have the proper authorization to view or edit them.

\*\*See the Setup screen of the configuration for authorization level(s) that are allowed unlimited resets per day.

Authorization passwords with level below 'Auth Level Bypass' are allowed only a limited number of resets.

Authorization passwords with level at and above 'Auth Level Bypass' are allowed unlimited lockout resets.

The image shows a configuration interface with two settings:

- Max Lockout Resets per Day:** A dropdown menu currently showing the value '6'.
- Auth Level Bypass:** A dropdown menu currently showing the value 'Supervisor Level'.

### 3.1. Authorized via the Keypad/LCD

Press 'Menu' - Use UP↑ to scroll to Password option

Press 'ENTER↵' key.

Using 'UP↑, DOWN↓', keys, to select/scroll number, press Right key → to move to next number

Press 'ENTER ↵' key to accept.

The authorization level will be displayed if a valid pin number is entered.



### 3.2. Authorized via MCS-CONNECT

1. Click on desired MicroMag in the Site Information screen.

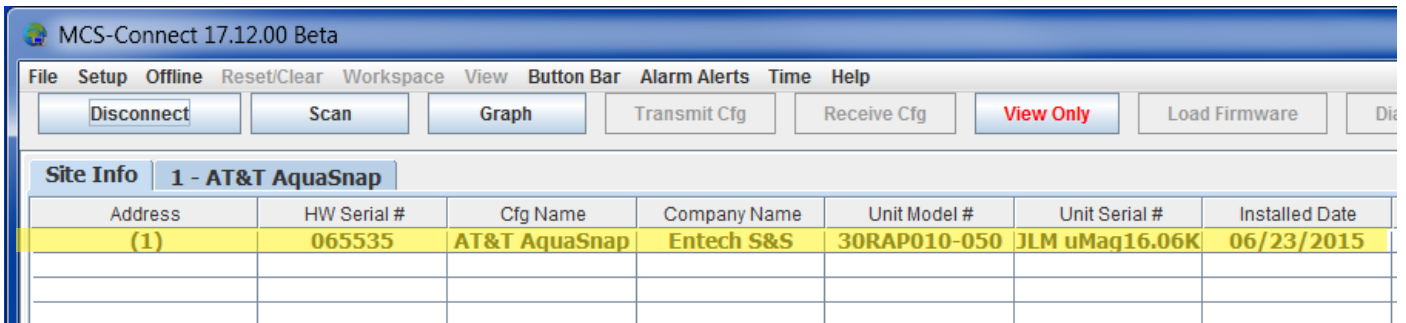

2. Click button 'VIEW ONLY' to get authorized to a higher level.

3. Enter the 4 digit password into the pop-up box and click ok (or press the enter key).

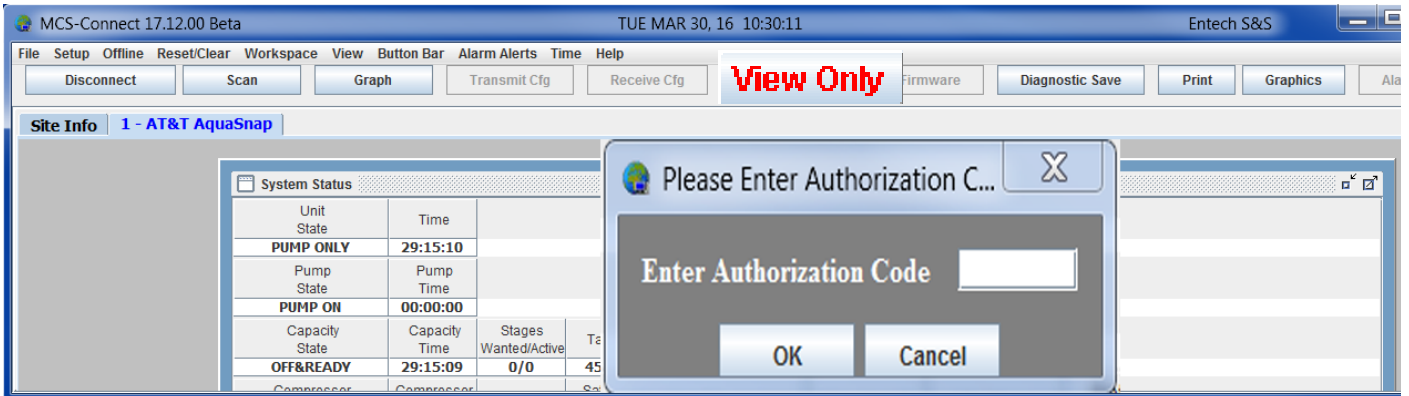

4. Depending on the authorization level, the button will change to one of the following displays, indicating if the password was accepted and what level.



# Chapter - 4. MicroMag Keypad

## 4.1. Main Menu Status

**NOTE: Scrolling Info LCD Display:**  
 When setup in the configuration file, the LCD will display the status points of the controller you are viewing every 10 seconds. After pressing a button, the scrolling will pause for 15 minutes before it continues.

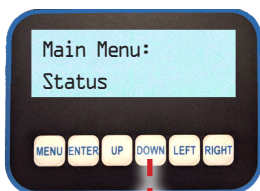

### Main Menu Status

'DOWN ↓ or UP ↑' buttons moves thru the MENU

- Outputs - RO's, AO's, Inputs - SI's, Service Tools, Setpoints,
- Alarms /Events. Lockouts -Clear, Enter Password

'MENU' button moves back to Main Menu Status display

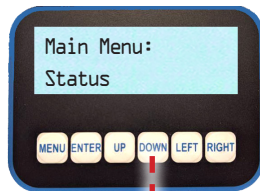
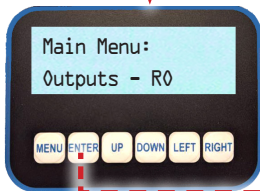

'MENU' button moves back to Main Menu Status display

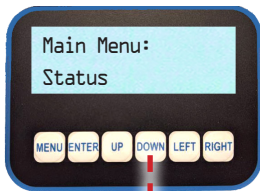
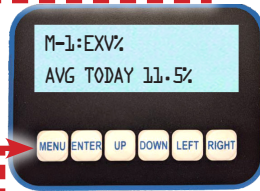
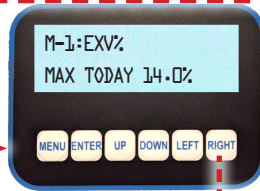
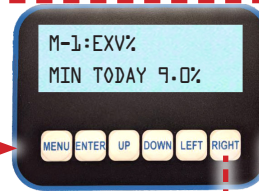
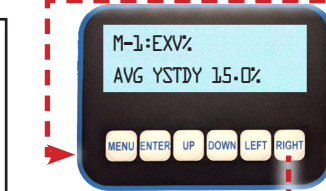
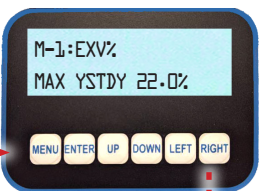
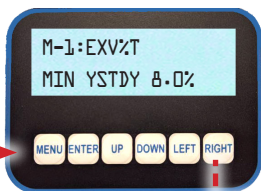
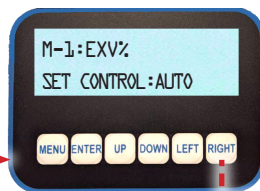
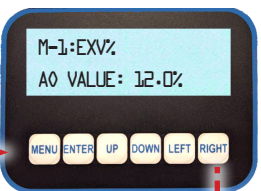
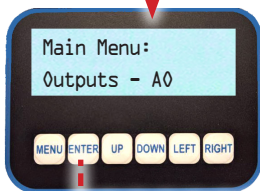

'MENU' button moves back to Main Menu Status display

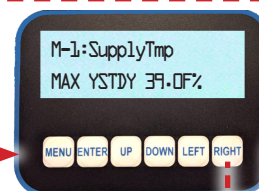
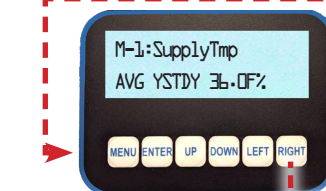
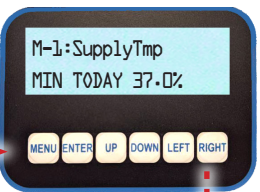
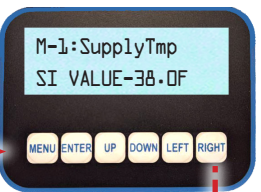
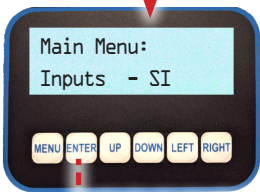

'DOWN ↓' button moves thru current SIs in configuration setup  
 RIGHT → button shows MIN/MAG/AVG values

## 4.2. Service Tools

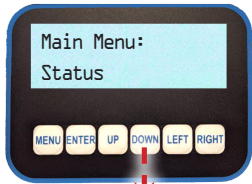

### Main Menu Status

'DOWN↓ or UP ↑' buttons moves thru the MENU

- Outputs - RO's, AO's, Inputs - SI's, Service Tools, Setpoints,
- Alarms /Events. Lockouts -Clear, Enter Password

'MENU' button moves back to Main Menu Status display

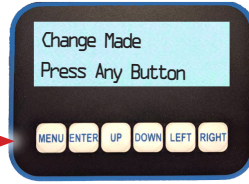
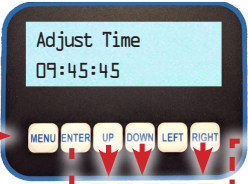
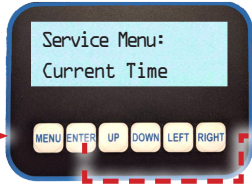
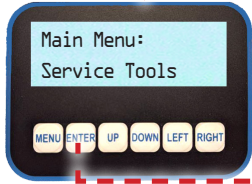

UP↑ DOWN↓ changes number  
RIGHT→ moves to minutes, seconds - ENTER ↵ saves change

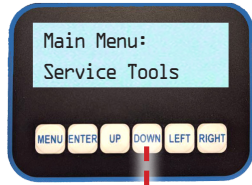

'SERVICE MENU' DOWN↓ button moves through service menu

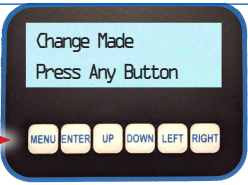
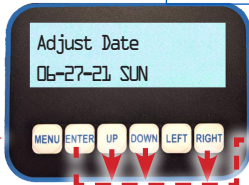
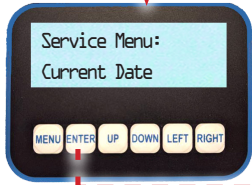

UP↑ DOWN↓ changes number  
RIGHT→ moves to minutes, seconds - ENTER ↵ saves change

NOTE: In countries and US states where Daylight Saving time is used, the setup is handled in the Configuration file as shown:

Daylight Savings Time		Spring Forward Month	March
Daylight Savings Time Active	<input checked="" type="radio"/> Yes <input type="radio"/> No	Spring Forward Begin Date	8
Daylight Savings Time DOW	Sunday	Spring Forward End Date	14
Daylight Savings Time Hour	2	Fall Back Month	November
		Fall Back Begin Date	1
		Fall Back End Date	7

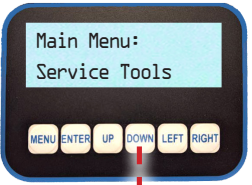

'SERVICE MENU' DOWN↓ button moves through service menu

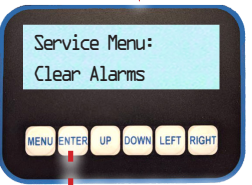

Higher Authorized needed to clear alarms  
NOTE: Alarms can only be cleared by ADMIN or MCS

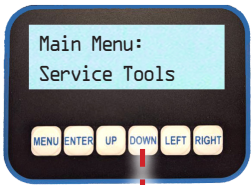

'SERVICE MENU' DOWN↓ button moves through service menu

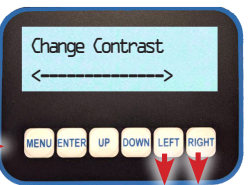

LEFT ← RIGHT → button changes contrast

**SERVICE TOOLS**

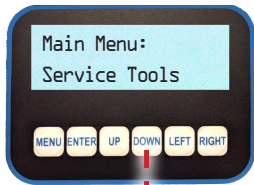

'SERVICE MENU' DOWN button moves through service menu

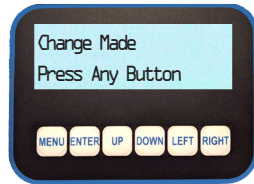
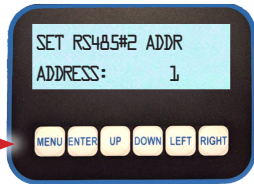
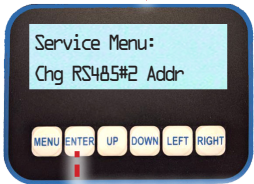

Addresses available  
• 1 to 250

Press DOWN button to change address  
ENTER saves change - Press any button to continue

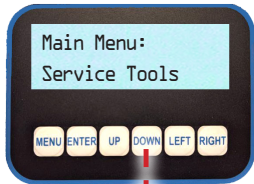

'SERVICE MENU' DOWN button moves through service menu

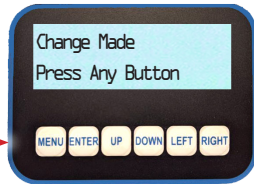
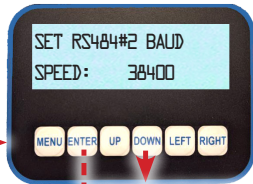
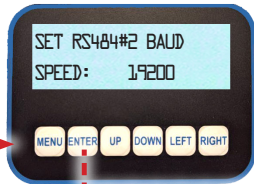
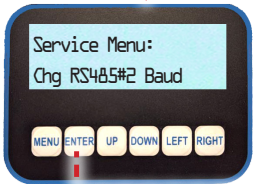

Available Baud Rates  
• 19200  
• 38400  
• 57600  
• 115200

Press DOWN button to change Baud rate  
ENTER saves change

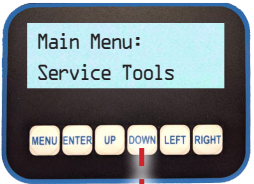

'SERVICE MENU' DOWN button moves through service menu

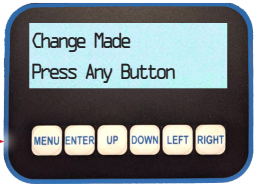
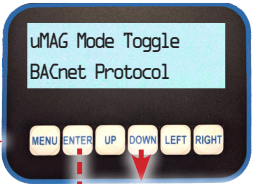

Available Protocols  
• MCS Protocol  
• Modbus RTU  
• BACnet Protocol

Press DOWN button to change Protocol  
ENTER saves change



'SERVICE MENU' DOWN button moves through service menu

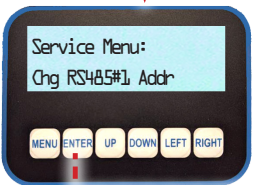

Addresses available  
• 1 to 250

Press DOWN button to change Protocol  
ENTER saves change

**SERVICE TOOLS**

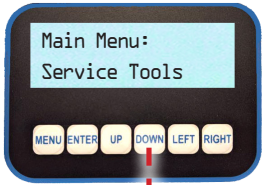

'SERVICE MENU' DOWN button moves through service menu

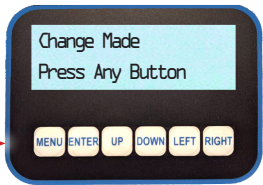
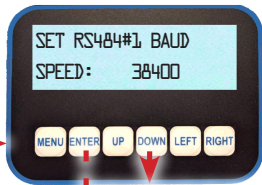
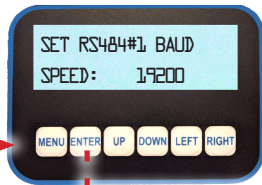
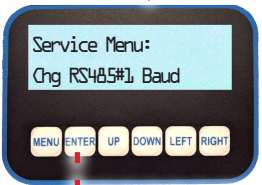

Available Baud Rates

- 19200
- 38400
- 57600
- 115200

Press DOWN button to change Baud rate  
ENTER saves change

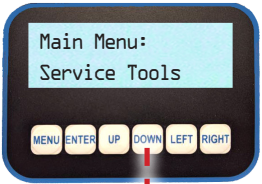

'SERVICE MENU' DOWN button moves through service menu

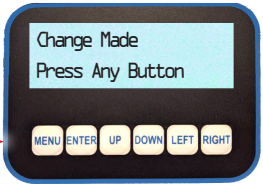
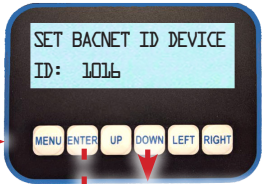
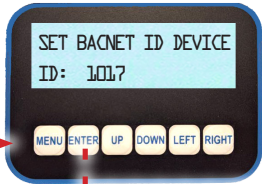
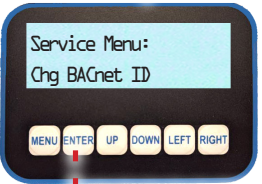

Available Device ID's

- 1 - 65535

Press DOWN button to change Baud rate  
ENTER saves change

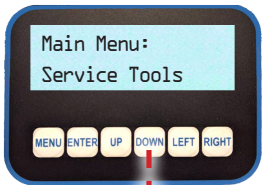

'SERVICE MENU' DOWN button moves through service menu

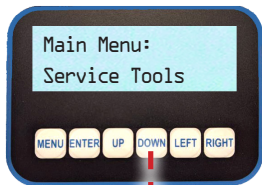
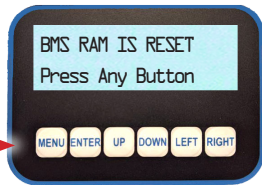
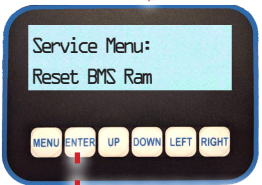

'SERVICE MENU' DOWN button moves through service menu

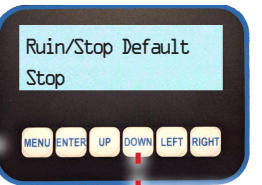
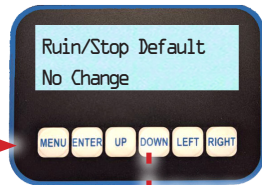
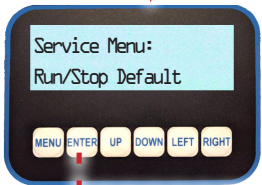

Press DOWN button to change RUN/STOP  
ENTER saves change



**SERVICE TOOLS**

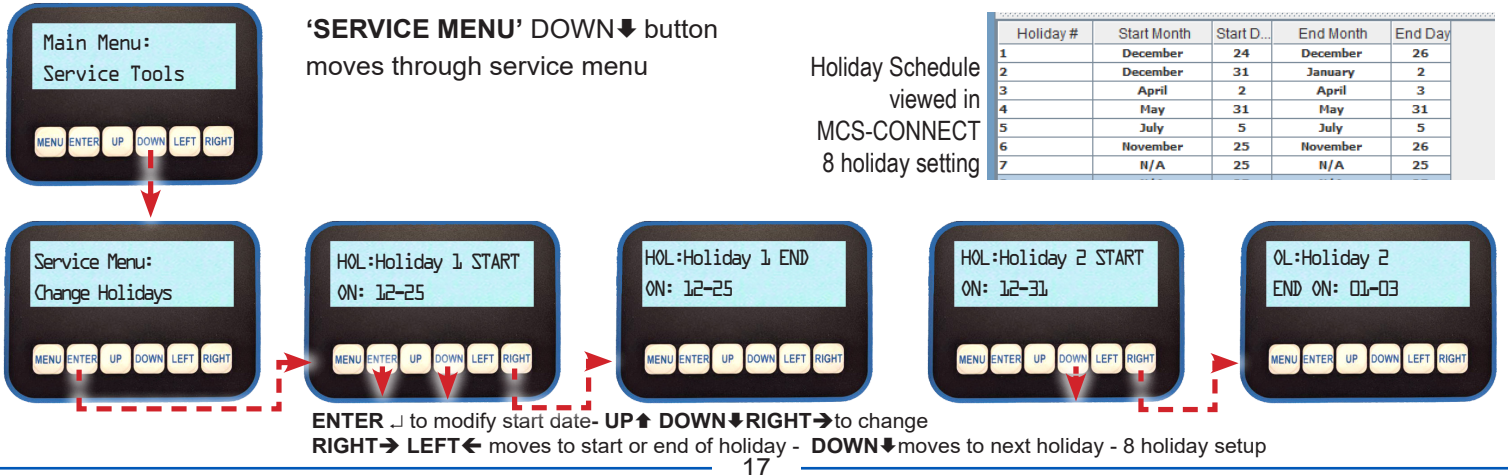
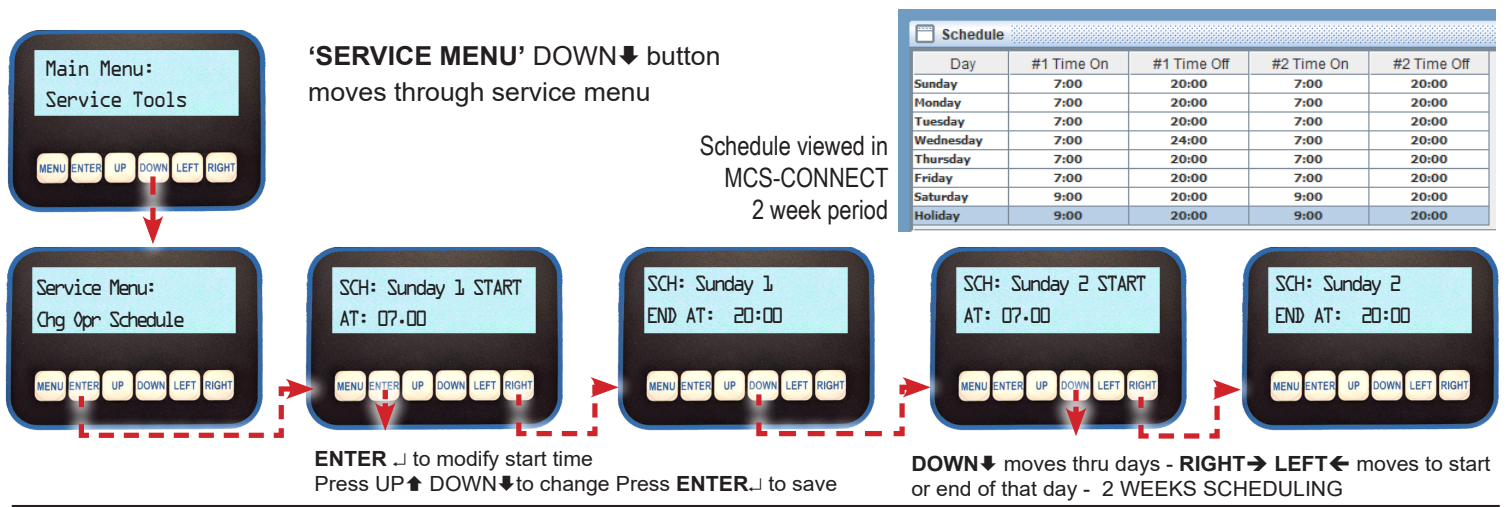
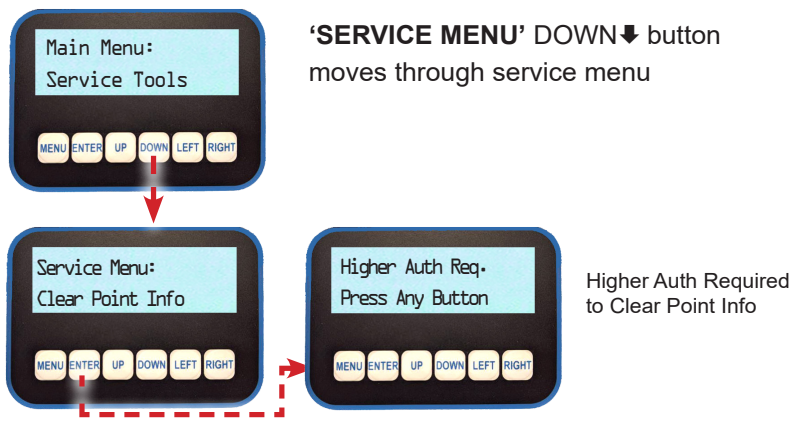
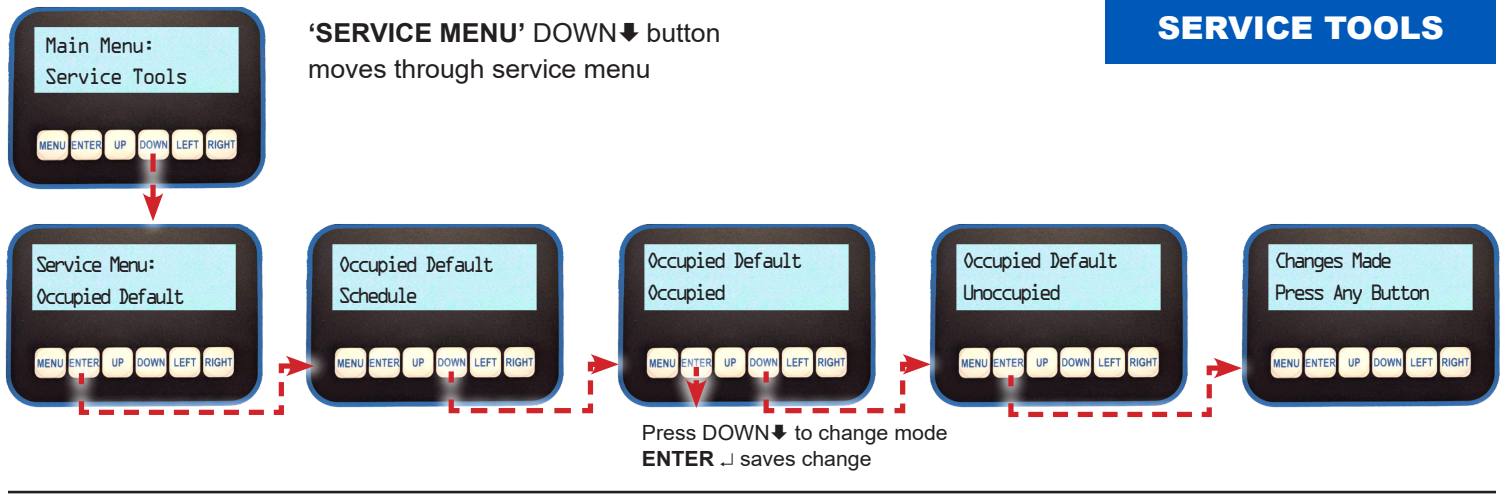

### 4.3. Viewing Alarms And Events

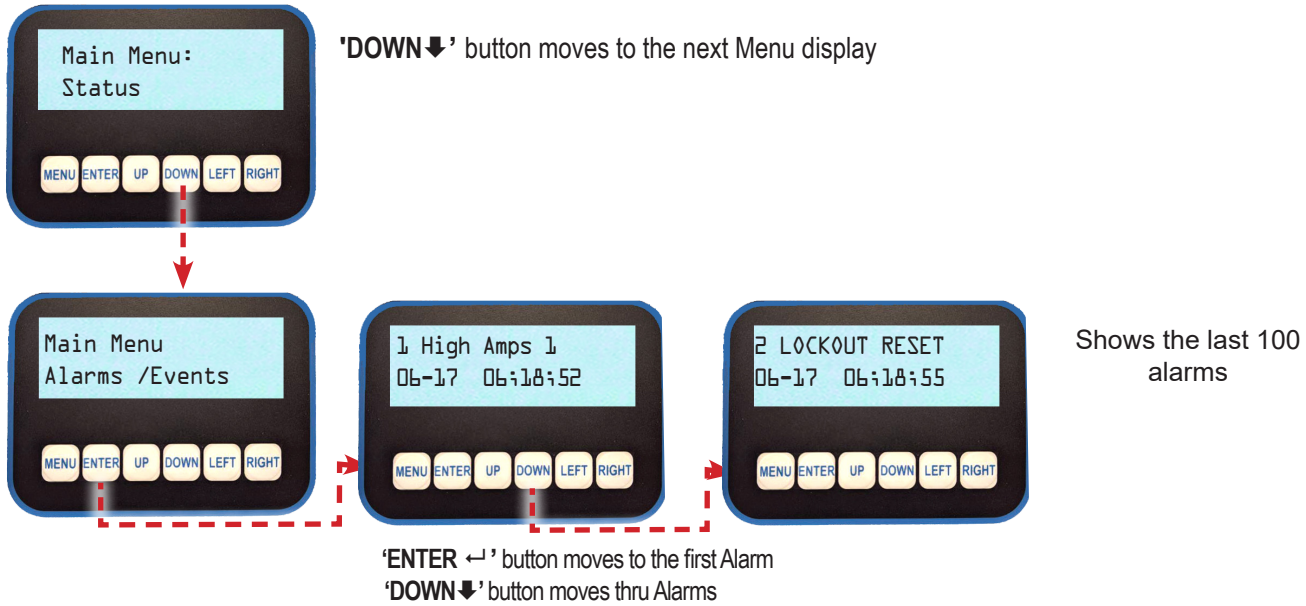

### 4.4. Lockout - Clear

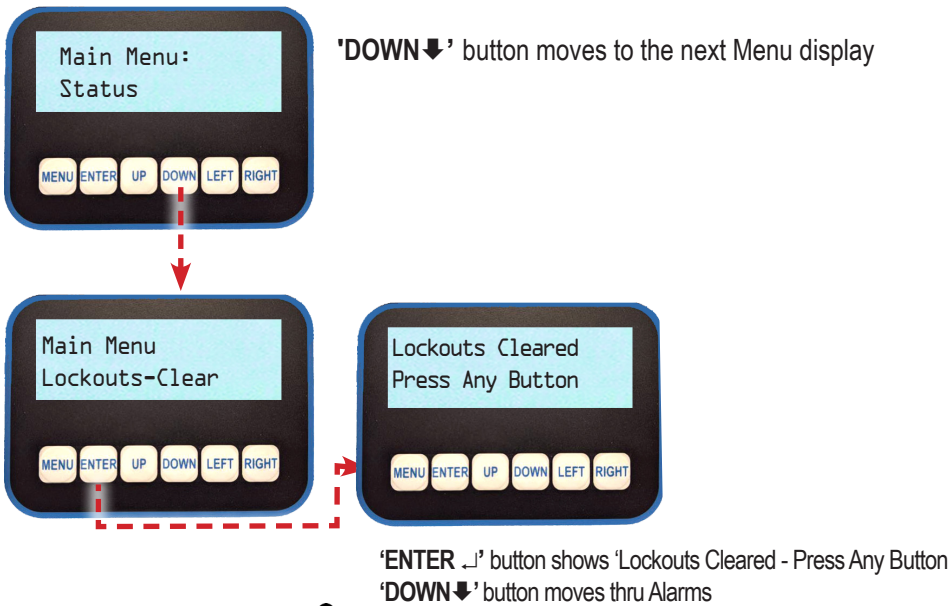

**Lockout Reset requires Factory Level Authorization or higher**

**Max Lockout Resets per day - 6**

**Authorization levels below 'Auth Level Bypass' are allowed only a limited number of resets.**

**Authorization levels at and above 'Auth Level Bypass' are allowed unlimited lockout resets.**

### 4.5. Changing Values of a Setpoint

**NOTE:** Additional changes can be made to a setpoint by pressing **RIGHT** button and moving thru the different value settings

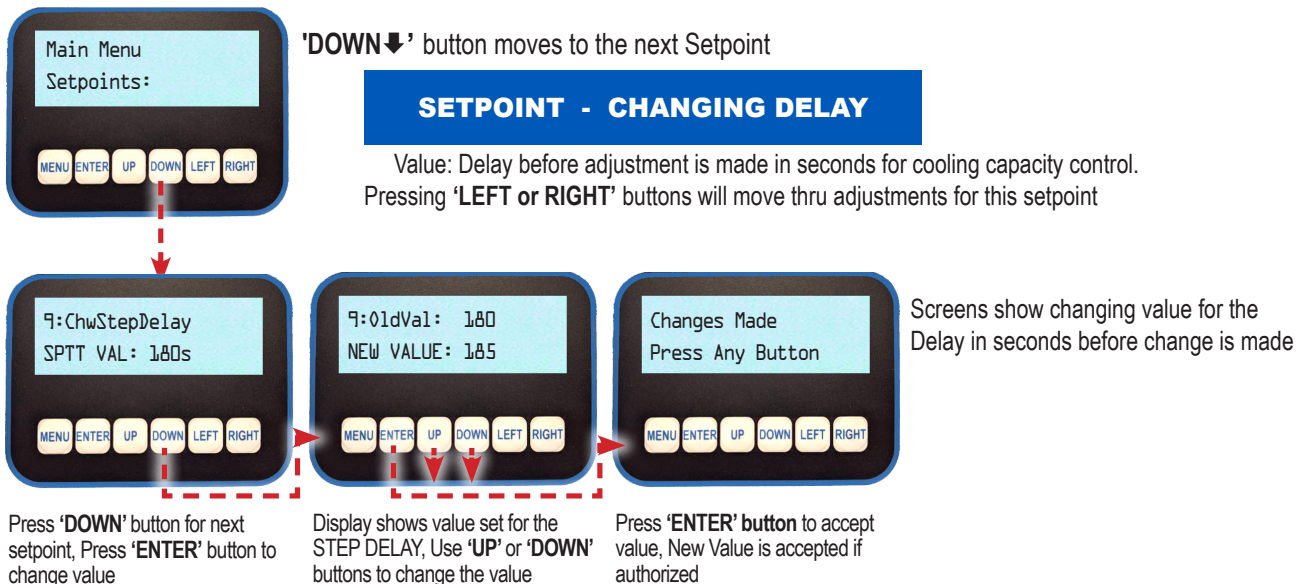
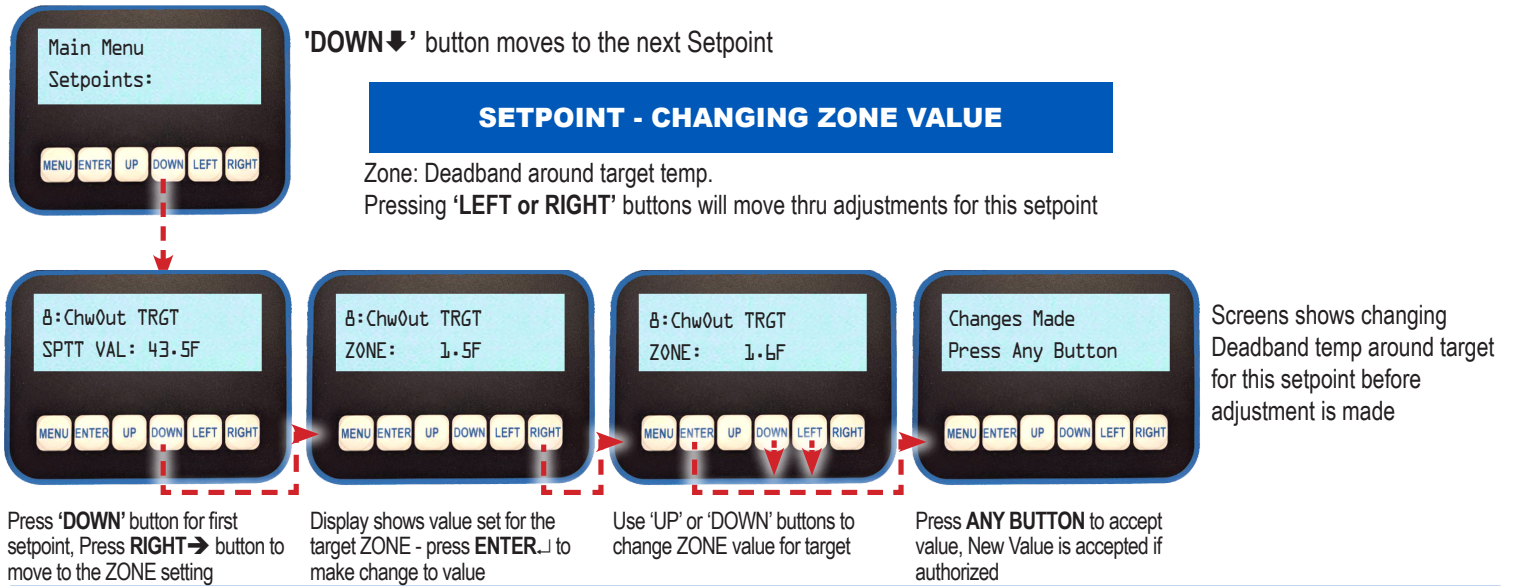
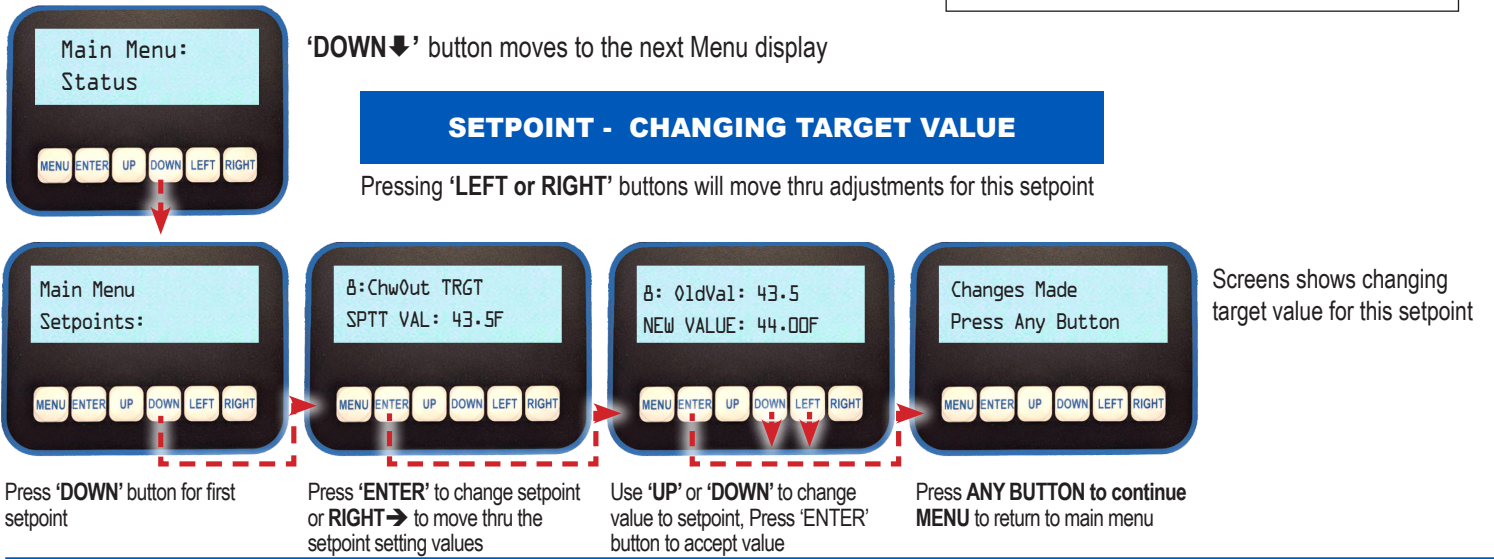

## 4.6. Viewing the Current Status of the Unit

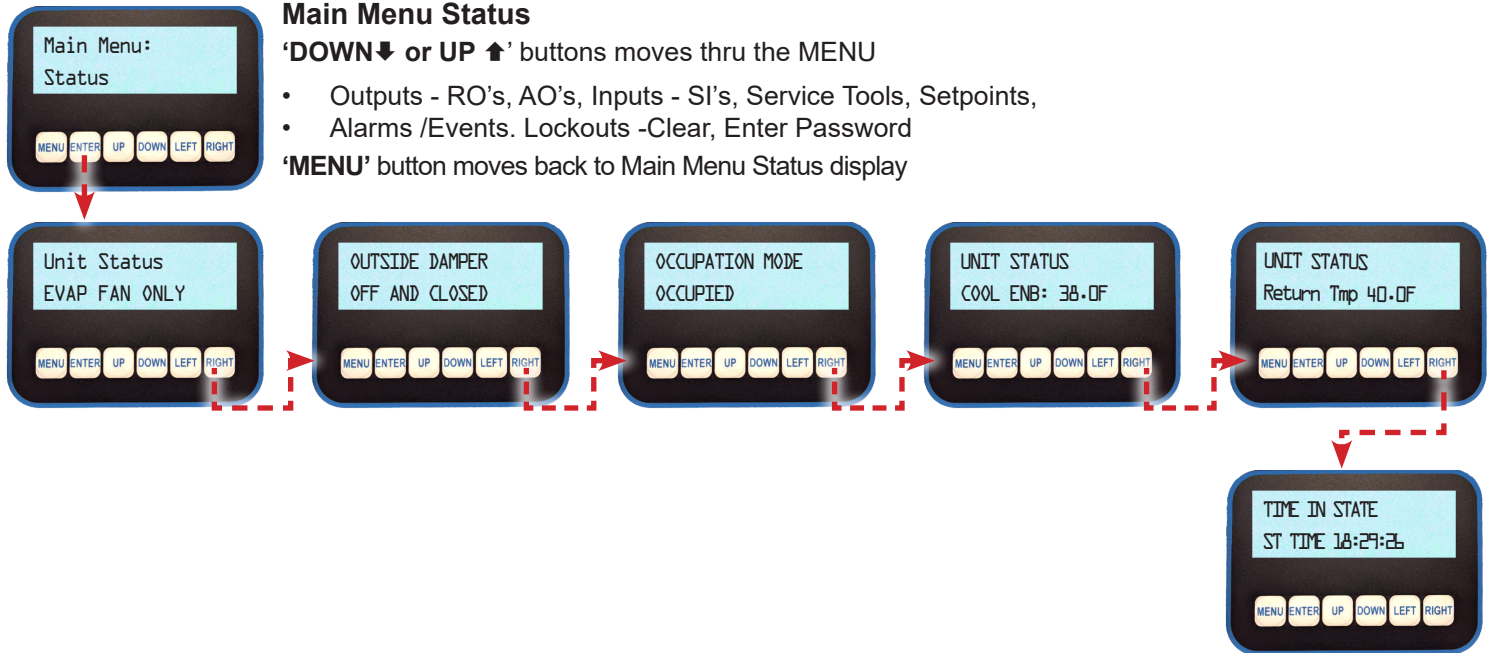

### 4.6.1 DEFAULT LCD DISPLAY

NOTE: Scrolling Info LCD Display: When setup in the configuration file, the LCD will display the status points of the controller you are viewing every 10 seconds. After pressing a button, the scrolling will pause for 15 minutes before it continues.

## Chapter - 5. MicroMag Communications Options

### 5.1. MicroMag's using MCS-CONNECT - MCS-USB-RS485

- Using MCS-USB-RS485 cable, connect Laptop to either RS485 terminal #1 or #2 as shown.
- Open MCS-CONNECT, click on Serial and scan for MicroMag(s).

Site Info		1 - 2COMP/2CKT							
Address	HW Serial #	Cfg Name	Company Name	Unit Model #	Unit Serial #	Installed Date	Cfg Vers	Firmware Vers	Cfg Date
(1)	065535	2COMP/2CKT	SKM,SHARJ...	APMR-6201...	AS0000149...	07/19/2020	18	SKM 18.000e	06/04/2021

- Select tab for a unit to see details of that MicroMag

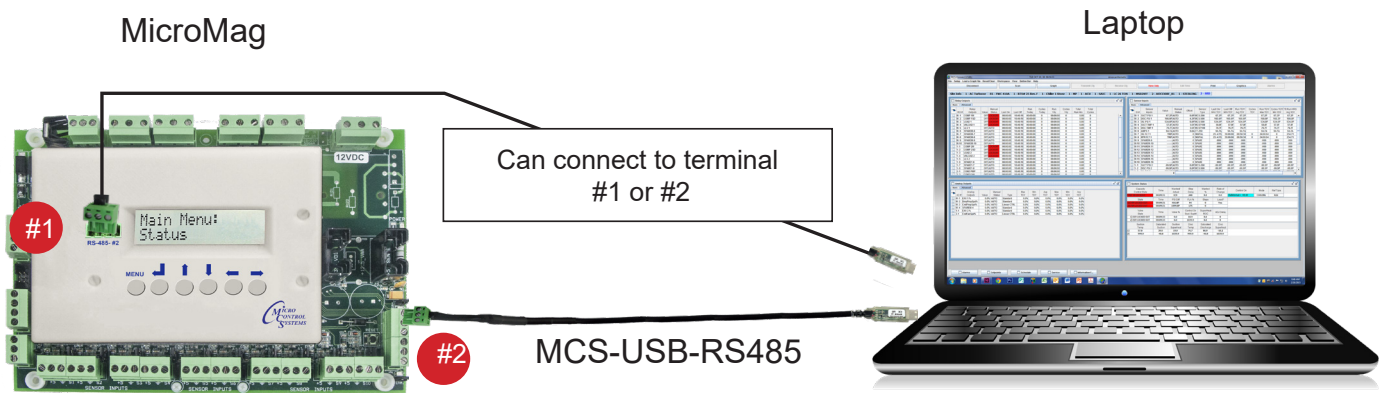

## 5.2. Multiple MicroMag's using MCS-CONNECT - RS485 and MCS-Touchscreen

- Uses MicroMag RS-485 #2 communications terminal
- Two wire shielded cable wired in straight line (NO STAR)
- Open MCS-CONNECT, click on Serial and scan for MicroMag(s)
- Select tab of MicroMag you want to view.

Site Info 1 - 2COMP/2CKT									
Address	HW Serial #	Cfg Name	Company Name	Unit Model #	Unit Serial #	Installed Date	Cfg Vers.	Firmware Vers.	Cfg Date
(1)	065535	2COMP/2CKT	SKM,SHARJ...	APMR-6201...	AS0000149-...	07/19/2020	18	SKM 18.00Oe	06/04/2021
(2)	065535	2COMP/2CKT	SKM,SHARJ...	APMR-6201...	AS0000149-...	07/19/2020	18	SKM 18.00Oe	06/04/2021
(3)	065535	2COMP/2CKT	SKM,SHARJ...	APMR-6201...	AS0000149-...	07/19/2020	18	SKM 18.00Oe	06/04/2021
(4)	065535	2COMP/2CKT	SKM,SHARJ...	APMR-6201...	AS0000149-...	07/19/2020	18	SKM 18.00Oe	06/04/2021

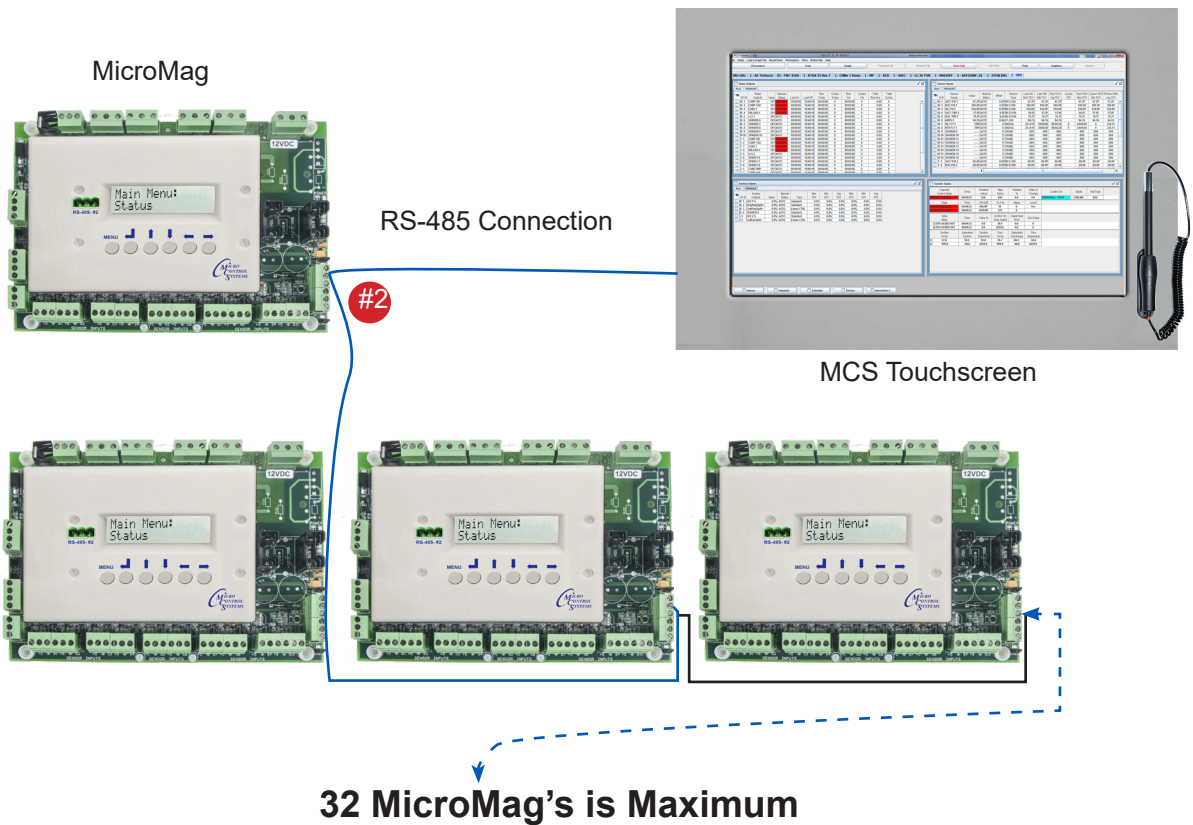

### 5.3. Multiple MicroMag's, over Internet using MCS-Connect & MCS-ETHERNET-RS485

- MCS-Connect maximum is 32 MicroMag's
- Uses MicroMag RS-485 #2 communications terminal
- Two wire shielded cable wired in straight line (NO STAR)
- At either end of RS-485 network install MCS-ETHERNET-RS485 to convert to Ethernet
- Connect to MCS-Ethernet-RS485 using MCS-Connect via IP Address
- Select the tab of MicroMag you want to view

File Setup Offline Reset/Clear Workspace View Button Bar Time Help Live Graph Extended History - Enable ALARM ALERTS-INACTIVE Analysis																					
Disconnect		Scan		Graph		Transmit Cfg		Receive Cfg		View Only		Load Firmware		Diagnostic Save		Print		Graphics		Alarms	
Site Info		1 - 2COMP/2CKT																			
Address	HW Serial #	Cfg Name	Company Name	Unit Model #	Unit Serial #	Installed Date	Cfg Vers.	Firmware Vers.	Cfg Date												
(1)	065535	2COMP/2CKT	SKM,SHARJ...	APMR-6201...	AS0000149-...	07/19/2020	18	SKM 18.000e	06/04/2021												
(2)	065535	2COMP/2CKT	SKM,SHARJ...	APMR-6201...	AS0000149-...	07/19/2020	18	SKM 18.000e	06/04/2021												

- Select tab for a unit to see details of that MicroMag

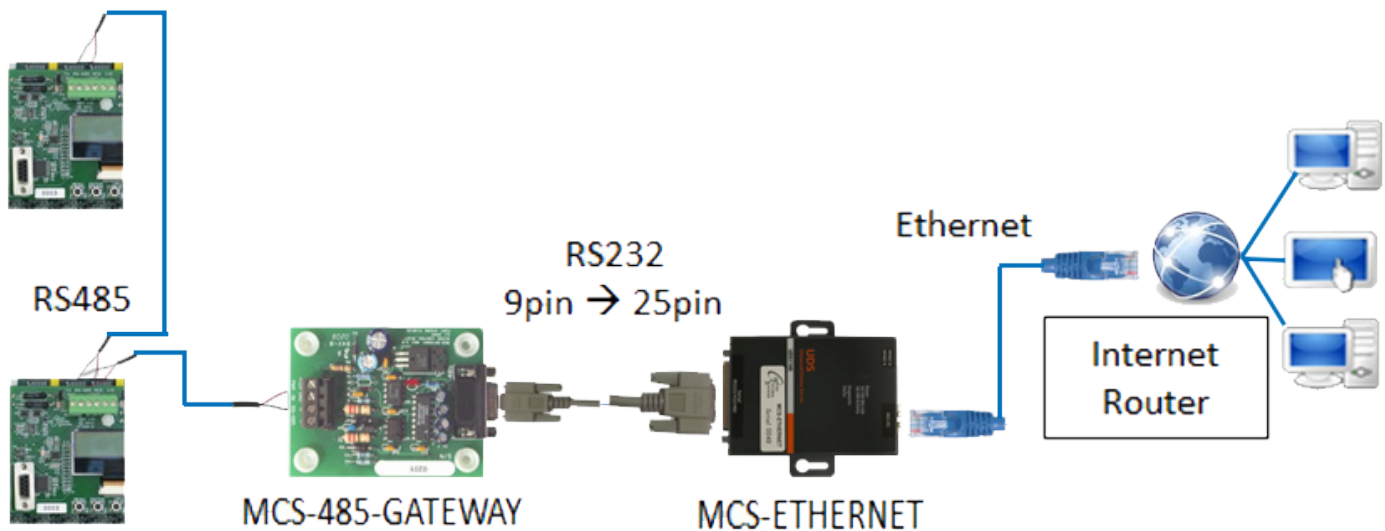

MCS-ETHERNET-RS485

- The MicroMag RS-485 port can be used to connect to the Internet using a MCS-ETHERNET-RS485 and internet static IP address

## Chapter - 6. MCS-CONNECT Software Support

MCS-Connect provides both local and remote communications to the MicroMag independent of software type. Local communications is through an RS 485 connection. This program displays the status of the controller, and changes can be made to the system with proper authorization. Configuration files can be transmitted to or received from a MicroMag unit. The MicroMag automatically performs history logging and this program allows the data to be presented in a useful graph form.

### Requirements for PC Software

To install and run the MCS-Connect program we suggest the following system requirements:

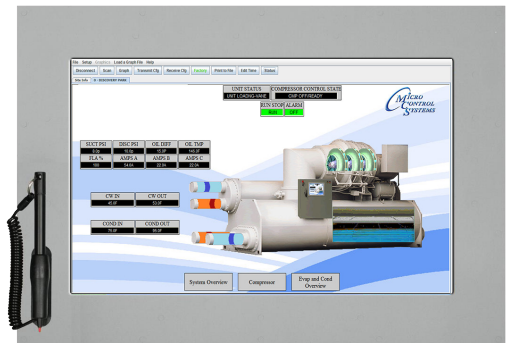

### Minimum System Required to Run Program

- PC with a Pentium2-class or higher processor or MCS TOUCHSCREEN - 10.1" or 15.4"
  - Windows 7 or MCS-Linux
  - Minimum 1GB of RAM
  - Minimum 4GB Drive
- 1280 x 800 pixel or higher display
- Ethernet 10m/100m/1000
- USB port 2.0 or higher



# Chapter - 7. MCS-CONNECT Screens

## 7.1. RTU STATUS

The screenshot displays the MCS-CONNECT software interface for an RTU. At the top, there is a menu bar and a row of site tabs. The main area is divided into several data tables and control panels. Red arrows point from labels to these features:

- Available Site Tabs:** A row of tabs at the top, including "Day CPM", "84 - Cond Level", "82 - FWC 410A", "0 - Master Control", "1 - MHRC #1", "0 - Master Control", "1 - WDT TEST", "0 - Soho-Day CPM", "1 - Ocean Plaza", "0 - 2nd Indus City", "1 - SHAW PARK", and "1 - THE RUMA HOTEL".
- Relay Outputs:** A table in the top-left quadrant showing relay status, manual status, and run cycles.
- Sensor Inputs:** A table in the top-right quadrant showing sensor values, manual status, and run cycles.
- Analog Outputs:** A table in the bottom-left quadrant showing analog output values and manual status.
- Selection Tabs:** A row of tabs at the bottom, including "Alarms", "Setpoints", "Schedule", "Service", "Information F...", "Unit Status", "Heat Status", and "OA Damper ...".
- Control Status:** A table in the bottom-right quadrant showing capacity, control state, and various status indicators.

The screen shot above shows the following features:

- Across the top is a row of tabs. The first is the Site Information screen which will show you details of all the MCS controllers available to establish a connection. The remaining tabs allow you to access each unit one by one respectively.
- There are four quadrants of information displayed for each MCS controller, namely: Relay Outputs, Analog Outputs, Sensor Inputs, and Unit Status (with six sub-menus of Status, Alarms, Setpoints, Reset/Clear, Schedule, and Service). Note: these screens may not always be displayed in the same position; MCS-CONNECT will automatically adjust the screen arrangement for optimum display information.

## 7.2. RTU RELAY OUTPUTS

RO #	Relay Outputs	Value	Manual Status	Last On	Last Off	Run Today	Cycles Today	Run Ydy	Cycles Ydy	Total Run Hrs	Total Cycles	Min. Run Time
M-1	SupplyFan	OFF	AUTO	17:17:25	15:18:59	15:19:04	0	24:00:10	0	75.50	5	-1
M-2	Comp 1	OFF	LOCKOFF	15:08:00	15:13:45	00:00:00	0	00:00:00	0	0.10	1	-1
M-6	ExhaustFan(ul)	ON	AUTO	17:17:10	17:16:59	16:01:26	0	24:00:10	0	76.25	4	0
M-7	Heat 1	OFF	AUTO	00:00:00	11:40:20	00:00:00	0	00:00:00	0	0.00	0	-1
1-1	InWarmUp	OFF	AUTO	00:00:00	11:40:20	00:00:00	0	00:00:00	0	0.00	0	-1

The screenshot above shows the following features:

- RO Number – Relay's M-1 is on and 1-1 is on.
- RO Names – Are up to 10 character and selected by the OEM for each output.
- RO Value – Can be On or Off.
- RO Status – Can be Auto, Manual or Locked off.
- Last On/Off – Last time turned on and off.
- Run Hrs Tdy, Ydy, Total – Run hours for Today, Yesterday and Total.
- Cycles Tdy, Ydy, Total – Cycles for Today, Yesterday and Total.

## 7.3. RTU ANALOG OUTPUTS

AO #	Analog Outputs	Value	Manual Status	Type	Max TDY	Min TDY	Avg TDY	Max YDY	Min YDY	Avg YDY
M-1	Economizer	0.0%	AUTO	Linear CTRL	0.0%	0.0%	0.0%	0.0%	0.0%	0.0%
M-2	SupFan %	0.0%	AUTO	Linear CTRL	100.0%	0.0%	94.6%	100.0%	100.0%	100.0%
M-3	ExhFan %	0.0%	AUTO	Linear CTRL	0.0%	0.0%	0.0%	0.0%	0.0%	0.0%
M-4	Reheat	0.0%	AUTO	Standard	0.0%	0.0%	0.0%	0.0%	0.0%	0.0%
1-2	CndFanSpd1	0.0%	AUTO	Standard	0.0%	0.0%	0.0%	0.0%	0.0%	0.0%

The screenshot above shows the following features:

- AO Number – M-T is on MicroMag, it is a triac output for a digital scroll compressor.
- AO Number – M-1 is the first analog output on the MicroMag.
- AO Names – A 10 character selected by the OEM for each output.
- AO Value – The current analog output value. (0 to 10 VDC or 10 to 0 VDC)
- AO Status – Auto or Manual.
- AO Type – Can be standard, inverted.
- Min/Max & Avg – For today and yesterday.

### 7.4. RTU SENSOR INPUTS

The screenshot shows a table of sensor inputs with the following columns: SI #, Sensor Inputs, Value, Manual Status, Offset, Sensor Type, Last On/ MAX TDY, Last Off/ MIN TDY, Run TDY/ Avg TDY, Cycles TDY, Run YDY/ Max YDY, Cycles YDY/ Min YDY, Ttl Run HRS/ Avg YDY, and Total Cycles. Red arrows point from callout boxes to specific columns: 'SI Number' points to SI #; 'SI Value' points to Value; 'SI Names' points to Sensor Inputs; 'SI Status' points to Manual Status; 'SI Offset' points to Offset; 'SI Type' points to Sensor Type; 'Last On/Off or Min/Max' points to Last On/ MAX TDY and Last Off/ MIN TDY; and '(Run Tdy, Ytd & Total) or (Avg Tdy, Max Tdy & Avg)' points to Run TDY/ Avg TDY, Cycles TDY, Run YDY/ Max YDY, Cycles YDY/ Min YDY, and Total Cycles. A separate callout 'Cycles (Today, Yesterday, Total)' points to the Cycles TDY, Cycles YDY/ Min YDY, and Total Cycles columns.

SI #	Sensor Inputs	Value	Manual Status	Offset	Sensor Type	Last On/ MAX TDY	Last Off/ MIN TDY	Run TDY/ Avg TDY	Cycles TDY	Run YDY/ Max YDY	Cycles YDY/ Min YDY	Ttl Run HRS/ Avg YDY	Total Cycles
M - 1	SPACE TEMP	76.5F	AUTO	1.0F	MCST100	76.5F	76.4F	76.4F		77.1F	72.4F	75.0F	
M - 2	SPACE HUMD	72.5%	AUTO	-3.0%	HUMD	72.5%	69.5%	71.1%		76.2%	47.3%	61.4%	
M - 3	SPLY TEMP	71.7F	AUTO	0.0F	MCST100	72.2F	71.4F	71.7F		77.9F	52.8F	67.9F	
M - 4	RTN AIRTMP	76.0F	AUTO	0.0F	MCST100	76.0F	75.8F	75.8F		77.0F	70.7F	74.7F	
M - 5	DCT CO2 A	445p	AUTO	0p	MCS CO2	464p	437p	449p		736p	455p	562p	
M - 6	DCT CO2 B	328p	AUTO	0p	MCS CO2	357p	322p	330p		683p	263p	472p	
M - 7	AIR FLOW	ON	AUTO	0	DIGITAL	17:26:06	17:25:08	02:05:23	0	24:00:16	0	725.06	7
M - 8	COND Coil	146.5F	AUTO	0.0F	MCST100	150.7F	145.1F	147.7F		158.0F	85.5F	131.9F	
M - 9	RUNSTOP SW	ON	AUTO	0	DIGITAL	17:25:00	17:24:59	02:05:23	0	24:00:16	0	725.29	2
M - 10	SPLYVDFLT	OFF	AUTO	0	DIGITAL	17:24:59	17:24:59	00:00:00	0	00:00:00	0	0.00	0
1 - 1	Evap Coil	72.6F	AUTO	0.0F	MCST100	73.1F	69.5F	71.5F		77.3F	52.2F	65.4F	
1 - 2	DCT STATIC	0.20"	AUTO	0.00"	STATIC5IB	0.23"	0.18"	0.20"		0.33"	0.07"	0.20"	
1 - 3	SUCT 1 PSI	181.2P	AUTO	0.0P	TI 667	187.6P	172.3P	182.4P		207.8P	115.5P	160.7P	
1 - 4	DISC 1 PSI	275.6P	AUTO	0.0P	TI 667	345.7P	246.0P	292.8P		411.4P	232.4P	299.1P	
1 - 5	AMPS	9.2A	AUTO	0.0A	CT300d2	14.2A	8.7A	9.8A		21.8A	0.0A	9.0A	
1 - 6	SUCT 1 TMP	75.1F	AUTO	0.0F	MCST100	75.5F	74.0F	74.8F		89.0F	56.8F	67.9F	
1 - 7	DISC 1 TMP	158.4F	AUTO	0.0F	MCST100	162.3F	157.6F	159.5F		167.2F	99.7F	148.5F	
1 - 8	PHASE LOSS	OFF	AUTO	0	DIGITAL	17:24:59	17:24:59	00:00:00	0	00:00:00	0	0.02	2
2 - 1	LIQ LN PSI	279.1P	AUTO	0.0P	TI 667	350.7P	233.0P	287.7P		411.2P	222.7P	291.1P	
2 - 2	LIQ LN TMP	90.5F	AUTO	0.0F	MCST100	98.9F	90.2F	94.0F		107.4F	81.3F	94.8F	
2 - 3	HEAT WHEEL	OFF	AUTO	0	DIGITAL	17:24:59	17:24:59	00:00:00	0	00:00:00	0	0.00	0
2 - 4	HL PSI SW	OFF	AUTO	0	DIGITAL	17:24:59	17:24:59	00:00:00	0	00:00:00	0	0.02	1
2 - 5	OUT TMP B	76.7F	AUTO	0.0F	MCST100	77.6F	76.7F	77.2F		90.8F	72.9F	79.1F	
2 - 6	OUT HMD B	86.8%	AUTO	0.0%	HUMD2	87.0%	80.4%	83.3%		95.7%	54.4%	82.3%	

The screen shot above shows the following features:

- SI Number – M-1 is on MicroMag relay 1, 1-1 is on RO board 1 relay 1.
- SI Names – A 10 character selected by the OEM for each input.
- SI Value – Actual analog value or for digital On or Off.
- SI Status – Auto or Manual
- SI Offset – Value to calibrate sensor..
- SI Type – Pressure, Temperature, Amps, etc.
- Last On/Last Off or Max Tdy/Min Tdy
- Run Tdy or Avg Tdy – Depending on analog or digital sensor.
- Cycles Today/Yesterday & Total.

## 7.5. RTU CONTROL STATES

The status of the control states of the unit can be viewed from MCS-CONNECT by clicking the “Status” screen in the Unit Status quadrant. The following screen will be displayed:

Unit State	Time	Mode	Cool Enable	Heat Enable	Dehumid Enable				
DEHUMID	00:04:25	UNOCCUPIED	73.5F	66.0F	65.0%				
Evap State	Evap Time	Target	Control On		Wanted %	ADJ Delay	Rate of Change		
HOLDING IZ	10:14:14	0.20"	DCT STATIC= 0.20"		85	0	0.00"		
Cooling State	Cooling Time	Stages Wanted/Active	Target	Control On		Wanted %	ADJ Delay	Rate of Change	
LOADING AZ	00:04:25	1/1	55.0F	SUCT 1 TMP= 70.5F		18	120	0.9F	
Compressor State	Compressor Time	FLA %	Saturated Suction	Suction Superheat	Saturated Condensor	Disc Superheat	Oil Differential	Lead?	
RUNNING	00:00:10	42	65.8	5.6	81.8	37.1	54.7P	Yes	
Condensor State	Condensor Time	Stages Wanted/Active	Target	Control On		Wanted %	ADJ Delay	Rate of Change	
UNLDING BZ	00:00:12	0/0	300.0P	DISC 1 PSI= 238.6P		20	120	3.0P	
Heating State	Time	Stages Wanted/Active	Target	Control On		Wanted %	ADJ Delay	Rate of Change	
OFF&READY	81:10:06	0/1	118.0F	SPLY TEMP= 72.5F		0	0	0.1F	
Reheat State	Time	Stages Wanted/Active	Target	Control On		Wanted %	ADJ Delay	Rate of Change	
HOLDING IZ	00:00:10	0/0	73.0F	SPLY TEMP= 72.5F		0	109	0.0F	

Navigation: Status | Alarms | SetPoints | Reset/Clear | Schedule

System (unit) information is shown in this section:

- **Unit State** - State of unit.

(DEHUMID STATE, EVAP STATE, COOLING STATE, COMPRESSOR STATE, CONDENSER STATE, HEATING STATE, REHEAT STATE)

- **Time** - Time spent in current state. If the state is UNIT IN POWER UP time will count down to zero.
- **Mode** – Whether occupied or unoccupied..
- **Enable Setpoints** – These are the Setpoints values that when controlling sensor is above or below enables function.

- **Evap State** – Can be Loading Below Zone (BZ), Unloading Above Zone (AZ) or Holding In Zone (IZ). Control is on duct static pressure and we have a modulating supply fan.

- **Time** - Time spent in current state.
- **Target** – The current value of the controlling Setpoint.
- **Control On** – The controlling Setpoint and its current value.
- **Wanted %** - The current value the computer has set for the evap fan.
- **ADJ Delay** – The time in seconds until the next possible adjustment.
- **Rate of Change** - The current slope of the controlling sensor over the time specified in the Setpoint.

- **Cooling State** – Can be loading AZ (above Zone, unloading BZ (below zone) or Holding IZ (in zone).

- **Time** - Time spent in current state.
- **Stages (Wanted/Active)** – Stages wanted on and stages currently on.
- **Target** – The current target in the Setpoint.

- **Control On** – The controlling sensor and it's current value.
  - **Wanted %** - For a digital scroll this is the % capacity wanted.
  - **ADJ Delay** – This is the accumulator for the integration controlling the next capacity change.
  - **Rate of Change** - The current slope of the controlling sensor over the time specified in the Setpoint.
- **Compressor State** – Can be Off or Running.
    - **Time** - Time spent in current state
    - **FLA %** - Percent of full load amps as specified in Setpoint.
    - **Saturated Suction** – Calculated Suction Saturated Temperature.
    - **Suction Superheat** – Calculated Suction Superheat, only available if both the Suction Temperature and the Suction Pressure are used. Suction Superheat = Suction Temperature - Suction Saturated Temperature.
    - **Saturated Condenser** - Calculated Suction Saturated Temperature.
    - **Discharge Superheat** – Discharge Superheat is available only if both the Discharge Temperature and the Discharge Pressure are used. Discharge Superheat = Discharge Temperature - Discharge Saturated Temperature.
    - **Oil Differential** – Differential oil pressure is calculated if both suction pressure and discharge pressure are available.
    - **Lead** - YES will be displayed for the lead compressor in this column.
- **Heating State** – Can be Off & Ready, Loading BZ (below zone), Unloading AZ (above zone), Holding IZ (in zone).
    - **Time** - Time spent in current state.
    - **Stages (Wanted/Active)** – Stages wanted on and stages currently on.
    - **Target** – The current target in the Setpoint.
    - **Control On** – The controlling sensor and it's current value.
    - **Wanted %** - For modulating heating this is the % capacity wanted.
    - **ADJ Delay** – This is the time delay until the next capacity change.
    - **Rate of Change** - The current slope of the controlling sensor over the time specified in the Setpoint.
- **Reheat State** – This feature is used in Dehumidification to maintain the zone temperature.
    - **Time** - Time spent in current state.
    - **Stages (Wanted/Active)** – Stages wanted on and stages currently on.
    - **Target** – The current target in the Setpoint.
    - **Control On** – The controlling sensor and it's current value.
    - **Wanted %** - For modulating heating this is the % capacity wanted.
    - **ADJ Delay** – This is the time delay until the next capacity change.
    - **Rate of Change** - The current slope of the controlling sensor over the time specified in the Setpoint.

## 7.6. RTU RESET/CLEAR

The screen shot above shows the Reset and Clear features:

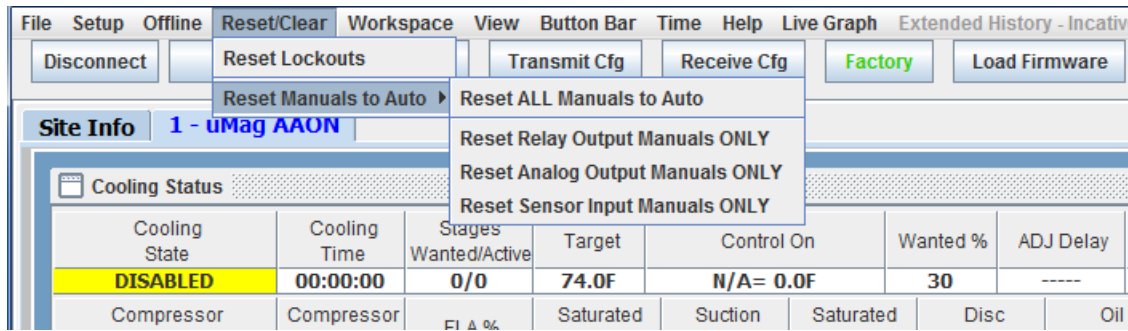

- **Reset Lockouts** – This does not require being authorized. However only a limited number of lockouts can be reset in one day without a higher authorization level.
- Reset Manuals to Auto –
  - Reset **Relay Output** Manuals ONLY
  - Reset **Analog Output** Manuals ONLY
  - Reset **Sensor Input** Manuals ONLY

## 7.7. RTU ALARMS

#	Alarm	Date	Time	Value
1	HI BLDG PSI	JUL 11	7:37:39	
2	HI BLDG PSI	JUL 10	18:07:38	
3	StptChg: 22	JUL 10	17:25:16	
4	UNIT PWR ON	JUL 10	17:24:59	
5	HI BLDG PSI	JUL 09	7:45:31	
6	StptChg: 7	JUL 03	21:39:46	
7	SI CHG @ M - 9	JUL 03	17:11:15	
8	RO CHG @ M - 1	JUL 03	17:11:10	
9	AO CHG @ M - 1	JUL 03	17:11:08	
10	AO CHG @ M - 1	JUL 03	17:09:11	
11	AO CHG @ M - 1	JUL 03	17:08:39	
12	AO CHG @ M - 1	JUL 03	17:07:42	
13	RO CHG @ M - 1	JUL 03	17:07:35	
14	SI CHG @ M - 9	JUL 03	17:02:10	
15	StptChg: 12	JUL 03	17:00:07	
16	StptChg: 12	JUL 03	16:59:57	
17	RO CHG @ M - 2	JUL 03	16:36:22	
18	AO CHG @ M - T	JUL 03	16:36:19	
19	StptChg: 14	JUL 03	16:32:12	
20	RO CHG @ M - 2	JUL 03	16:25:52	

The screen shot above shows the 1<sup>st</sup> 20 Alarms. There are a maximum of 100 of the most current.

- The alarms are numbered and the most current presented first.
- The alarms are named, this could be the name of a Setpoint or a specific alarm name.
- The alarms are date stamped.
- The alarms are time stamped.
- The alarms record a value where it's informative.

## 7.8. List of Alarms Generated by MicroMag

ALARMS CLEARED  
AO CHANGED  
AUTH CODES  
CLOGGED FILTER  
COMM TYPE BACNET  
COMM TYPE BASE  
COMM TYPE MCSIO  
COMM TYPE MODBUS  
COMPRESSOR SPEED  
CONDENSER ALARM  
CONFIG INVALID  
CONFIG TRANSMITTED  
DRAIN ALARM  
EMERGENCY STOP  
FAILED RO  
FAILED SI  
FIRE ALARM  
FREEZE TEMP  
HEATER FAULT  
HEATER FAULT  
HI AMPS ALARM  
HI DISCHARGE PSI  
HI MOTOR TEMP  
HI OIL TEMP  
HI SUPPLY TEMP  
HI SUPPLY TEMP  
HIGH BUILDING PRESSURE  
HIGH DISCH TEMP  
HIGH DUCT PRESSURE  
HIGH PSI SWITCH  
HIGH PSI SWITCH  
HIGH SUCT SUPERHEAT  
IGNITION FAULT  
KEYPAD ALARM BREAKPOINT  
LO DISC SUPERHEAT  
LO SUCT SUPERHEAT  
LOAD ALARM  
LOCKOUT RESET  
LOST IO RESTART  
LOW AMPS ALARM  
LOW DISC PSI  
LOW OIL DIFF PSI  
LOW PSI SWITCH  
LOW PSI SWITCH  
LOW SUCTION PSI  
MODBUS ANALOG CHANGED  
MODBUS CONFIGURATION CHANGED  
MODBUS CONSTANT CHANGED  
MODBUS RELAY CHANGED  
MODBUS SI CHANGED  
NETWORK OCCUPIED  
NETWORK RUN STOP  
NO COMP PROOF  
NO FLOW  
OIL LEVEL  
PHASE LOSS  
POINT INFO CLEARED  
POWER ON  
PRECOOL FREEZE TEMP  
PUMP DOWN  
REMOTE STOP  
RO CHANGED  
RTC INVALID  
SENSOR FAULT  
SETPOINT CHANGED  
SI CHANGED  
SMOKE ALARM  
THERMOSTAT COMM FAILED  
UNSAFE OIL DIFF PSI  
UNSAFE SUCTION  
USER CYCLE COUNT RESET  
VFD FAULT

### 7.9. RTU SCHEDULES

Day	#1 Time On	#1 Time Off	#2 Time On	#2 Time Off
<b>Sunday</b>	<b>8:00</b>	<b>8:00</b>	<b>8:00</b>	<b>8:00</b>
<b>Monday</b>	<b>8:00</b>	<b>18:30</b>	<b>8:00</b>	<b>18:00</b>
<b>Tuesday</b>	<b>8:00</b>	<b>18:30</b>	<b>8:00</b>	<b>18:00</b>
<b>Wednesday</b>	<b>8:00</b>	<b>18:30</b>	<b>8:00</b>	<b>18:00</b>
<b>Thursday</b>	<b>8:00</b>	<b>18:30</b>	<b>8:00</b>	<b>18:00</b>
<b>Friday</b>	<b>8:00</b>	<b>18:30</b>	<b>8:00</b>	<b>18:00</b>
<b>Saturday</b>	<b>8:00</b>	<b>8:00</b>	<b>8:00</b>	<b>8:00</b>
<b>Holiday</b>	<b>8:00</b>	<b>17:00</b>	<b>8:00</b>	<b>17:00</b>

Holiday #	Start Month	Start Day	End Month	End Day
1	December	15	December	21
2	December	15	December	21
3	December	15	December	21
4	December	15	December	21
5	December	15	December	21
6	December	15	December	21
7	December	15	December	21
8	December	15	December	21

Status	Alarms	SetPoints	Reset/Clear	Schedule
--------	--------	-----------	-------------	----------

The screen shot above shows the schedules.

- There are 2 on/off schedules per day.
- There are 7 days and 1 holiday schedule.
- There are 8 holiday dates.

### 7.10. RTU INFORMATION SCREEN

<ol style="list-style-type: none"> <li>1. The Sensor Input Value, Manual Status, Type and Offset Value can be changed by clicking on the cell.</li> <li>2. Information on Control States and the status of the system.</li> <li>3. The Sensor Input Value, Manual Status, Type and Offset Value can be changed by clicking on the cell.</li> <li>4. Information on the Schedule for this Magnum</li> <li>5. The Sensor Input Value, Manual Status, Type and Offset Value can be changed by clicking on the cell.</li> </ol>
---

The screen shot above shows the information screen acknowledging action taken.

- Information is provided.
- Confirmation is given that a function has been done.



A FULL DESCRIPTION OF ALL BUTTONS AND TABS CAN BE FOUND IN THE MCS-CONNECT MANUAL ON OUR WEB SITE AT:

<http://www.mcscontrols.com/manuals.html>



## Chapter - 8. EXV Control

### 8.1. EXV STATES

The EXV Control States show the status of the compressor's expansion valve. If the compressor has an EXV it will be displayed under the Status entry.

System Status								
Unit State	Time							
<b>PUMP ONLY</b>	<b>00:20:26</b>							
Pump State	Pump Time							
<b>PUMP ON</b>	<b>00:00:00</b>							
Capacity State	Capacity Time	Stages Wanted/Active	Target	Control On	Wanted %	ADJ Delay	Rate of Change	
<b>NO FLOW</b>	<b>00:20:48</b>	<b>0/0</b>	<b>45.0F</b>	<b>ChwOutTemp= 45.0F</b>	----	----	<b>0.0F</b>	
Compressor State	Compressor Time	FLA %	Saturated Suction	Suction Superheat	Saturated Condenser	Disc Superheat	Oil Differential	Lead?
<b>DISABLED</b>	<b>00:20:26</b>	<b>0</b>	<b>44.1</b>	<b>15.9</b>	<b>107.0</b>	<b>48.0</b>	<b>222.0P</b>	<b>Yes</b>
<b>DISABLED</b>	<b>00:20:26</b>	<b>0</b>	<b>44.1</b>	<b>15.9</b>	<b>107.0</b>	<b>48.0</b>	<b>222.0P</b>	
<b>DISABLED</b>	<b>00:20:26</b>	<b>0</b>	<b>-40.0</b>	<b>40.0</b>	<b>-40.0</b>	<b>40.0</b>	<b>0.0P</b>	
<b>DISABLED</b>	<b>00:20:26</b>	<b>0</b>	<b>-40.0</b>	<b>40.0</b>	<b>-40.0</b>	<b>40.0</b>	<b>0.0P</b>	
EXV State	Time	Valve %	Control On Suct. Supht	SuperHeat ROC	ADJ Delay			
<b>EXV CLOSED</b>	<b>00:47:25</b>	<b>0</b>	<b>15.9F</b>	<b>0.0F</b>	<b>60</b>			
<b>EXV CLOSED</b>	<b>00:47:25</b>	<b>0</b>	<b>40.0F</b>	<b>0.0F</b>	<b>60</b>			
Condenser State	Condenser Time	Stages Wanted/Active	Target	Control On	Wanted %	ADJ Delay	Rate of Change	
<b>COND OFF</b>	<b>00:47:23</b>	<b>0/0</b>	<b>300.0P</b>	<b>DISC 1 PSI= 350.0P</b>	----	<b>0</b>	<b>0.0P</b>	

- **EXV CLOSED** - The associated compressor is OFF and the valve is closed
- **EXV COMP PRE-PMPDWN** - The valve has been in a closed state and the system is now requiring the valve action.
- **EXV IS HOLDING** - Superheat is in control zone and ROC is acceptable.
- **EXV COMP STARTUP** - At startup the valve will remain in this state for the time in Setpoint #133. At that time the state will be changed to holding, at this point the valve control logic will position the valve. AT 100% This state will be entered when the valve opening reaches 100%.
- **EXV IS OPENING** - Superheat is in control zone but rising too fast, ROC less than 1.0.
- **EXV IS CLOSING** - Superheat is in the control zone and the rate of change is acceptable, ROC greater than -0.5.
- **EXV LOW SUPERHEAT** - Force a course valve adjustment.
- **EXV OPENING 4x** - Superheat is above control zone.
- **EXV OPENING 2x** - Superheat is in control zone but rising too fast, the ROC is greater than 1.0.
- **EXV LOW SUCT OPEN 1X** - State indicates that a low suction pressure condition exists.
- **EXV CLOSING 2x** - Superheat is in the control zone and the rate of change is acceptable, the ROC is less than -0.5 and greater than -1.0.
- **EXV CLOSING 4x** - Superheat is in control zone but falling too fast, ROC less than -1.0.
- **EXV MOP CLOSING** - Maximum operating pressure option is active and it is forcing the EXV to close. In this state the EXV valve's opening will be reduced.

- **EXV MOP HOLDING** - Maximum operating pressure option is active and it is forcing the EXV to hold.

## 8.2. EXV LOGIC

### 8.2.1 EXV TARGET (Setpoint #132)

#	Name	Value	Min	Max	Adjust Value	Time (SEC)	Max Time Allowed (SEC)	Lockout Delay (HRS)	Safety Down Time(MIN)	Active or Non-Active	Select Value: # decimals & print char
131	SPARE STPT	0	0	0	0	---	---	---	---	Non-Active	... Spare
132	EXV TARGET	12	6	20	0.1	---	---	---	---	Active	... TEMP
133	EXV ADJUST	60	30	90	1	---	---	---	---	Active	... SECONDS
134	EXV LO SPRHT	2	1	5	0	---	---	---	---	Active	... TEMP
135	EXV MOP TARG	175	170	350	1	---	---	---	---	Active	... PSI GAGE

- EXV control is bases on superheat. Value is the target the MicroMag Chiller will control from.
- Zone: is the dead band around the superheat target.
- Max Roc Value: The max Roc that the EXV control will allow to determine opening or closing of the EXV.
- ROC Interval: The time interval the Roc is calculated over.
- Adjust Mult/Div: Scales any calc. changes to EXV value based on controlling SI'S proximity to the target.

### 8.2.2 EXV ADJUST (Delay) (Setpoint #133)

- Determines how quickly to adjust the EXV valve percentage. The farther the superheat is from the target the quicker the step delay will work to reach setpoint.
- Min Adjust % Valve: EXV value % will not be adjusted greater than this value.
- Max Adjust Valve %: EXV valve % will not be adjusted greater than this value.
- Min Cap %: EXV min % position.
- Max Cap %: EXV max % position.
- Delay M/O: Scales calc changes to EXV step delay.

### 8.2.3 EXV LOW SUPERHEAT (Time) (Setpoint #134)

- If calculated superheat remains below the value set in this setpoint a safety trip occurs.

### 8.2.4 EXV MOP (Maximum operating pressure) TARGET (Setpoint #135)

- Value is maximum suction PSI that EXV control will allow before closing off valve.
- Zone: Dead band around target PSI.
- ROC: Setting are the same.
- Adjust M/O: Scales calculation changes to EXV % based on MOP target controlling PSI's proximity.

# Chapter - 9. MCS-CONNECT - GRAPHICS

## 9.1. Graphics Screen

MCS-Graphics is a feature available in MCS-CONNECT. The Graphics feature allows the user to view a graphical interface for your controller using the touch screen or your PC.

To get to the 'GRAPHICAL' interface follow the instructions below.

1. At MCS-CONNECT main screen click on the 'SERIAL' button to scan for your controller. On a PC you must have a MCS-USB-RS485 cable from your PC to the MicroMag RS485 port.

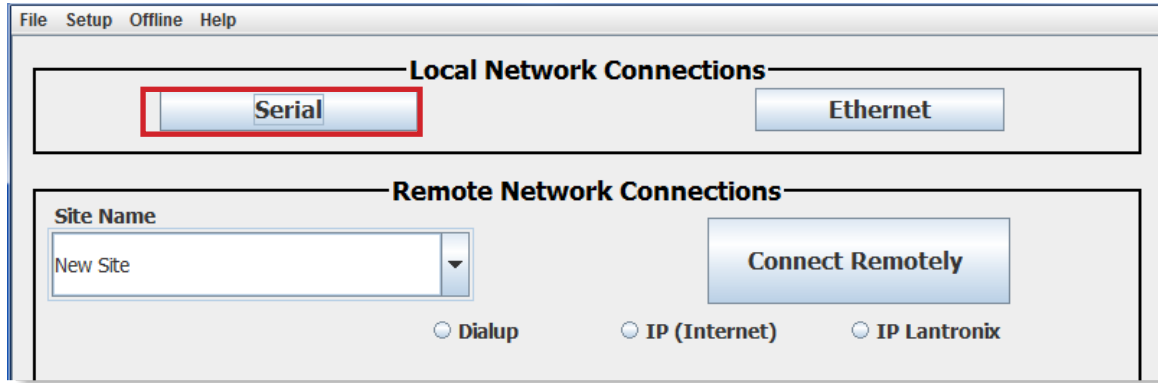

2. Scan shows 1 controller for the MicroMag controller.
3. Click on the controller to open.

The screenshot shows the 'Site Info' screen for '1 - uMag AAON'. It features a toolbar with buttons like Disconnect, Scan, Graph, Transmit Cfg, Receive Cfg, View Only, Load Firmware, Diagnostic Save, Print, Graphics, and Alarms. Below the toolbar is a table with the following data:

Address	HW Serial #	Cfg Name	Company Name	Unit Model #	Unit Serial #	Installed Date	Cfg Vers	Firmware Vers	Cfg Date
(1)	065535	uMag AAON	MCS	WJR	uMag V18C	09/12/2016	18	AAON 18.00C	02/15/2017

4. Next screen shows status screen in MCS-CONNECT for your controller.

The screenshot shows the 'Status' screen for '1 - uMag AAON'. It contains several data panels:

- Cooling Status:** Shows 'DISABLED' with a cooling time of 00:00:00 and a target of 74.0F. It lists compressor states as OFF&READY.
- Analog Outputs:** Lists AO #1 (Comp Spd 1), AO #2 (Comp Spd 2), and AO #3 (Heat Dmnd 1), all with manual status 'OFF' and 'AUTO'.
- Relay Outputs:** Lists RO #1 (Cool 1), RO #2 (Cool 2), and RO #3 (Alarm), with manual status 'OFF' and 'AUTO'.
- Sensor Inputs:** Lists 10 sensors (SI #1-10) including CHH Dmnd, StgEnbl 1, StgEnbl 2, DehumDmnd, Heat Enbl, Oia Temp, AirFlow, and S/A Temp, with various manual statuses and values.

At the bottom, there are buttons for Schedule, Service, Unit Status, Heat Status, Alarms, Setpoints, and Information F...

5. When you received your new controller, the MCS-CONFIG program has been setup to locate your graphic file.
6. If you need to change the graphics for your controller, follow the steps on the next page.

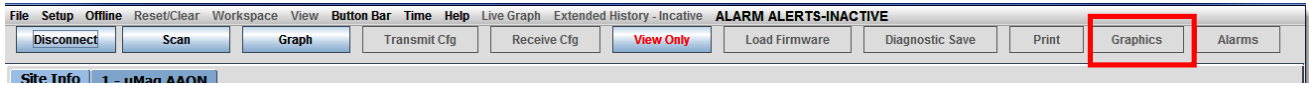

7. Click the button for 'GRAPHICS' to open the graphical interface as shown below.



## 9.2. Changing the Graphics

If you need to change the 'GRAPHICS PACKAGE' for your controller, consult with MCS SUPPORT for upgrading. Follow the steps below for changing the your graphics.

For changing the graphic package on a touchscreen, download the 'TOUCHSCREEN AND GRAPHICS MANUAL' located on our web site at:

<http://www.mcscontrols.com/manuals.html>

When you receive your new 'GRAPHIC.ZIP' file, double click to open the file and place the new file in the MCS/ GRAPHICS location on your 'C' drive on your computer.

If the graphics file is the same name as the old file, click okay to overwrite the old file.



**NOTE: YOU SHOULD ALWAYS BACKUP YOUR FILES PRIOR TO LOADING NEW GRAPHIC FILES.**

If the file name was the same you can skip the next steps and proceed to open your graphics as was explained above.

**IF NOT PROCEED TO THE NEXT STEPS ON THE FOLLOWING PAGE**

## 9.2.1 Graphics File Update

Follow the steps below to register a new graphic file for your controller.

1. At the status screen of MCS-CONNECT, click on the 'SERVICE' button at the bottom of the screen.

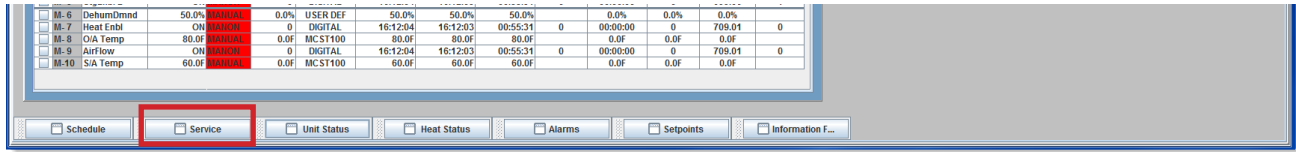

2. The service window will open, click on the Graphics tab to open.

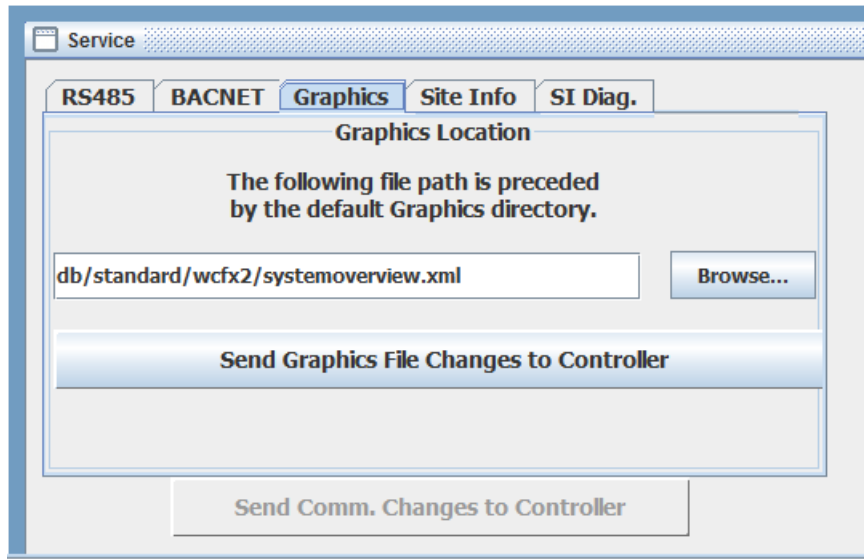

3. Click on the 'BROWSE' button to search for your graphics package. If you placed the file in the MCS/GRAPHICS sub folder, you can click on the file. The location of the file should show in the box next to browse.
4. Click '**SEND GRAPHICS FILE CHANGES TO CONTROLLER**'
5. Your controller should reboot in MCS-CONNECT, click on the '**GRAPHICS**' tab at the top to view your new graphics.

## Chapter - 10. ALARMS

- Last 100 Alarms are saved
- In print out below a LOCKOUT was created. (#21)
- The System responded with “SPLY FREEZE” Alarm & Info (#13)
- The Freeze was reset (#11)

#	Alarm	Date	Time	Additional Info
1	SI CHG @ 1 - 7	MAR 24	12:02:44	
2	SI CHG @ M - 8	MAR 24	12:02:30	
3	SI CHG @ M - 8	MAR 24	11:57:55	
4	SI 2 OFFLINE	MAR 24	11:56:13	
5	SI 1 OFFLINE	MAR 24	11:56:13	
6	RO 1 OFFLINE	MAR 24	11:56:13	
7	LCKOUT RESET	MAR 24	11:56:13	
8	SI 2 OFFLINE	MAR 24	11:56:12	
9	SI 1 OFFLINE	MAR 24	11:56:12	
10	RO 1 OFFLINE	MAR 24	11:56:12	
11	LCKOUT RESET	MAR 24	11:56:12	
12	SI CHG @ M - 2	MAR 24	11:56:11	
13	SPLY FREEZE	MAR 24	11:55:51	Info
14	SI CHG @ M - 2	MAR 24	11:55:44	
15	SI CHG @ M - 8	MAR 24	11:54:47	
16	SI CHG @ M - 8	MAR 24	11:54:04	
17	SI CHG @ M - 8	MAR 24	11:53:50	
18	SI 2 OFFLINE	MAR 24	11:53:23	
19	SI 1 OFFLINE	MAR 24	11:53:23	
20	RO 1 OFFLINE	MAR 24	11:53:23	
21	LCKOUT RESET	MAR 24	11:53:23	

- Click on 'Info'.
- Click on the tab selecting the items you want to see.
- By selecting the "SI's" you can see the freeze temperature at @ 34°F.
- You can review all other info to see effect.

**Lockout Alarm Information**

ROs	SI's	AOs	Unit	Evap	Cool & Comp.	Cond	Reheat	Heat & ModGas
Time	SPLY TEMP □	OUTDR TEMP □	OUTDR HUM...	SPACE TEMP □	AIR FLOW □	RUNSTOP S...	CLOG FILTR □	BLD STATIC □
14:05:47	34.0F	88.0F	55.0%	75.0F	ON	ON	OFF	0.01"
14:05:46	34.0F	88.0F	55.0%	75.0F	ON	ON	OFF	0.01"
14:05:45	34.0F	88.0F	55.0%	75.0F	ON	ON	OFF	0.01"
14:05:44	34.0F	88.0F	55.0%	75.0F	ON	ON	OFF	0.01"
14:05:43	34.0F	88.0F	55.0%	75.0F	ON	ON	OFF	0.01"
14:05:42	34.0F	88.0F	55.0%	75.0F	ON	ON	OFF	0.01"
14:05:41	34.0F	88.0F	55.0%	75.0F	ON	ON	OFF	0.01"
14:05:40	34.0F	88.0F	55.0%	75.0F	ON	ON	OFF	0.01"
14:05:39	34.0F	88.0F	55.0%	75.0F	ON	ON	OFF	0.01"
14:05:38	34.0F	88.0F	55.0%	75.0F	ON	ON	OFF	0.01"
14:05:37	34.0F	88.0F	55.0%	75.0F	ON	ON	OFF	0.01"
14:05:36	34.0F	88.0F	55.0%	75.0F	ON	ON	OFF	0.01"
14:05:35	34.0F	88.0F	55.0%	75.0F	ON	ON	OFF	0.01"
14:05:34	34.0F	88.0F	55.0%	75.0F	ON	ON	OFF	0.01"
14:05:33	34.0F	88.0F	55.0%	75.0F	ON	ON	OFF	0.01"

## Chapter - 11. Graph Capabilities of MicroMag and MCS-CONNECT

MCS-CONNECT has the ability to pull back both 'STATIC' and 'LIVE GRAPH' trending history for the MicroMag controller it is monitoring.

The MicroMag controller captures history of the status for all RO, AO and SI points based on the setup of your configuration file. Through MCS-Config, the user is also able to setup additional "USER LOGIC" statements to capture additional internal information for plotting.

For example, you might want to capture and 'graph' information on the Unit States, Compressor States, EXV States, Number of compressors Wanted on and Actual on, Suction and Discharge Superheat, Saturated Suction and Discharge, etc. The insert on the right shows an example of setting up EXV State.

When the GRAPH button is selected, the screen below will appear. On the MCS-8 the # of samples is 144 and can be retrieved in about 1 minute. In the MAGNUM the number of samples is 1008 and will take about 3 + minutes to pull back.

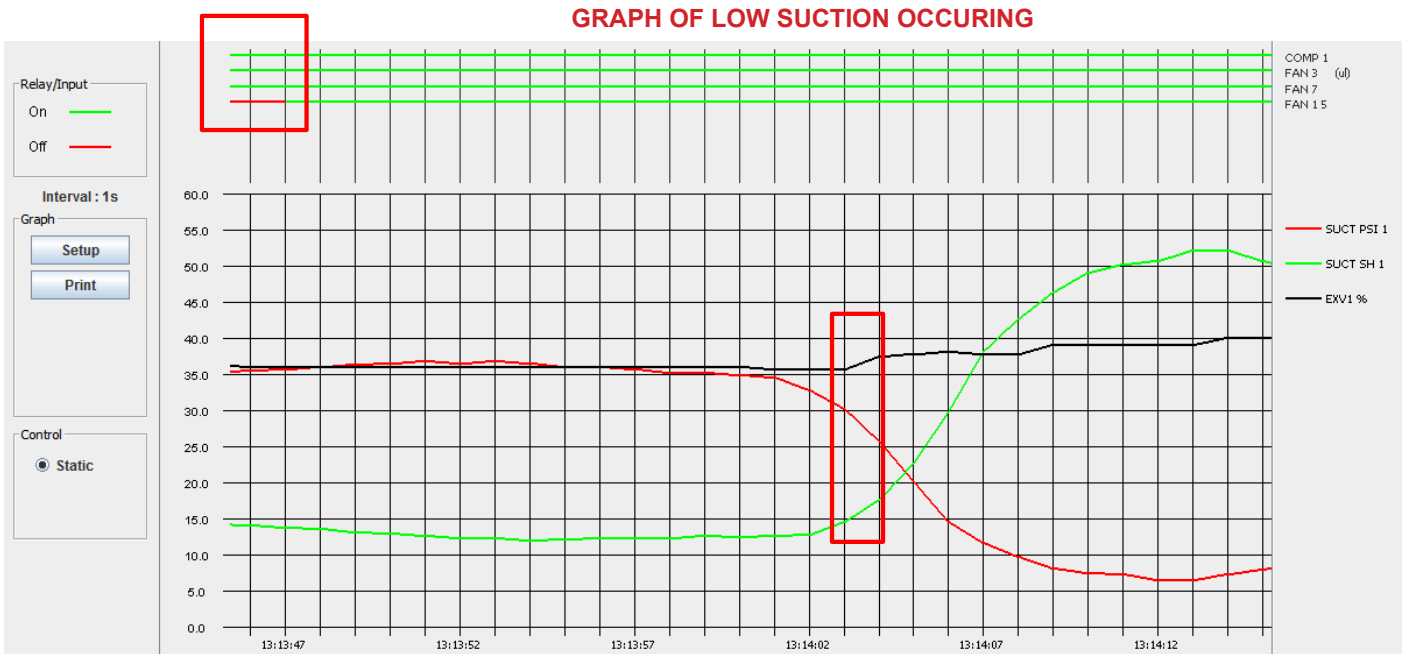
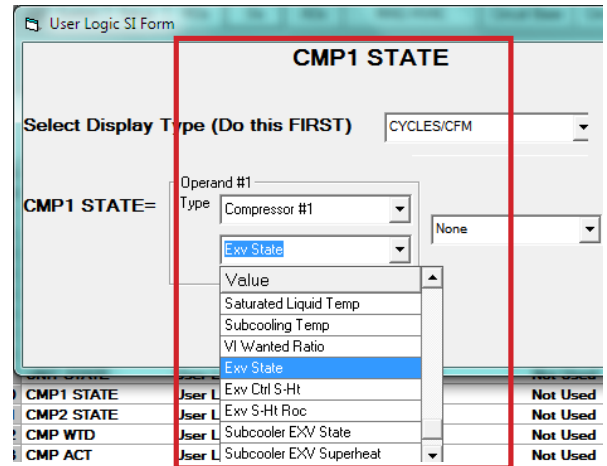

The above screen contains the following:

The Relay Outputs and the Digital Inputs are graphed across the top of the screen with line bars. The ON/OFF status coding is indicated to the left of the line bars and the name of the set points being graphed is on the right. The items being graphed can be changed in the SETUP screen.

The Analog Inputs are charted on the graph grid. The name of the points being graphed is to the right of the grid, note the color-coding. The slide bar on the bottom of grid is used to move the portion of the graph being displayed. The X-axis contains the time intervals, and Y-axis, contains the value range. Items being graphed can be changed in the SETUP function.

The following pages will show you how to setup for seeing and saving the Graph History for your unit.



All inputs & outputs are saved on an ongoing basis. There are 300 of the most current samples available when requested. The time period covered is based on the sample time selected.

The chart below provides some indication of the time span covered based on the static time selected.

SAMPLE TIME	TIME COVERED
1 SEC	0 HR 5 MIN
6 SEC	0 HR 30 MIN
30 SEC	2 HR 30 MIN
1 MIN	5 HR 0 MIN
10 MIN	2 DAY 2 HRS
30 MIN	6 DAYS 6 HRS
60 MIN	12 DAYS 12 HRS



*To pull back the current static data, from the status display in MCS-CONNECT, click the “Graph” tab.  
To pull back a ‘LIVE GRAPH’, click on the ‘LIVE GRAPH’ tab.*

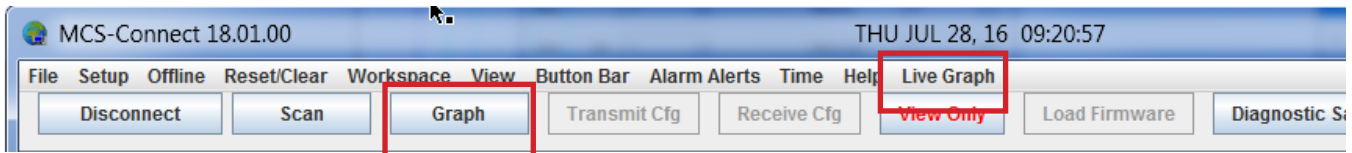

**FOR ADDITIONAL INFORMATION ON THE GRAPH CAPABILITIES OF YOUR  
MICROMAG CONTROLLER  
PLEASE REFER TO THE MCS-CONNECT MANUAL AT:**

[www.mcscontrols.com](http://www.mcscontrols.com)

## 11.1. Graph Setup Tabs

When you click on the Graph button, the screen will display the following, plus if you have a saved 'GRAPH FILE', MCS-CONNECT will begin pulling back the history for the points you have saved for that graph file. Click on 'STOP HISTORY PULLBACK' to setup a new 'GRAPH'.

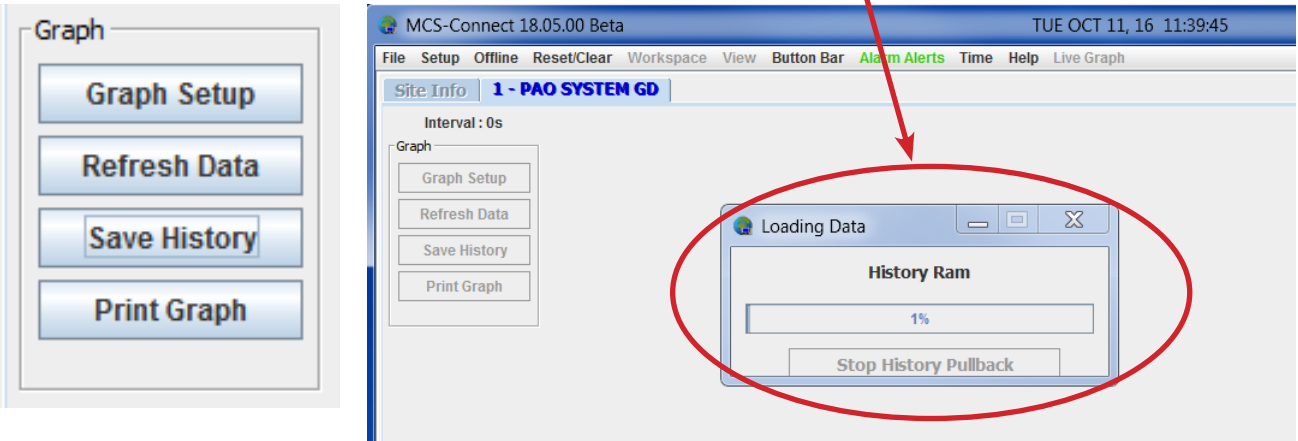

### 11.1.1 Graph Setup Button

This function allows changes to be made to the graph setup function.

When the SETUP button is clicked on, the following screen will appear. Here you will pick the points you want to graph, the 'INTERVAL(time)', and the 'Y-AXIS values'

#### 11.1.1.1 Interval and Y AXIS SETUP

1. **Interval (s)** - Sets the given amount of seconds (time) you wish to graph
2. **Y-Axis Max** - Highest point of the graph
3. **Y-Axis Min** - Lowest point of the graph

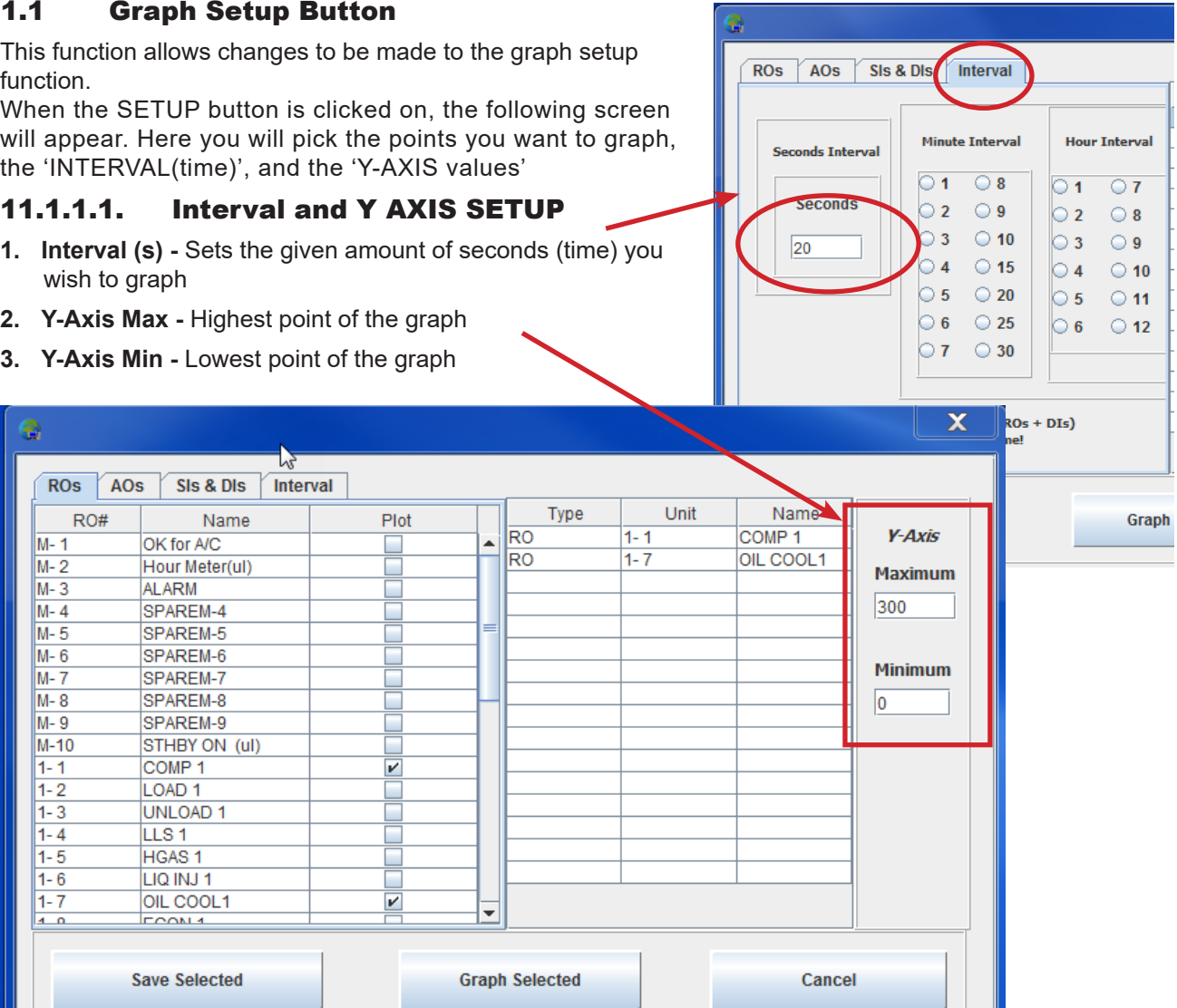

This Graph setup screen displays in tabbed pane at top of the screen: the RELAY OUTPUTS(RO), ANALOG OUTPUT(AO), SENSOR INPUT(SI's) or DIGITAL INPUT(DI's) of all the points in this configuration file.

To add a point to the list that will be graphed, move the cursor to the check box next to the point you wish to graph, and click. The name will be added to the Points to Graph list in the right screen of the popup and a check mark will appear in the box. To remove an item from the list, click on the box to remove the check mark. The item will be removed from the Points to Graph list.

When you are finished adding the points, you can click 'Save Selected', which will save all points for the controller you are viewing. If you view another MCS controller you can setup the graph points so each time you view the MCS controller your points for the graph will be loaded for that MCS controller.

Clicking 'Graph Selected' will plot the current selections in the graph.

The Y-Axis section contains the maximum and minimum setting for the Y-axis. The axis is divided proportionally between these two points divided by the # of lines specified.

**YOU ARE LIMITED TO A MAXIMUM OF EIGHT(8) DIGITALS AND EIGHT (8) ANALOGS ON A GRAPH**

Click on Interval to see the setup for the sampling times.

The Interval tab enables the interval to be changed. The time is recorded in seconds. Click on the appropriate radio buttons in minutes or hours. The Seconds History Interval Box automatically updates in seconds. (You may double click on the seconds box and put in a value as small as 2 seconds).

Save Selected- Clicking on this button will enable the current settings to be saved. If the settings are saved, they will be active when the system is again accessed.

Cancel - Clicking on this button will return control to the GRAPH screen. None of the changes that were made will be reflected on this screen. The original settings will be used.

### 11.1.2 Refresh Data Button

This function will reread the history data that is being accumulated, thus providing fresh data to be graphed.

### 11.1.3 Save History Button

This function will save the current history data with sensor names as a '.Txt' formatted file.

The standard Window SAVE AS screen will appear. Specify the name of the file and where it is to be saved. The file can be read into a spreadsheet program such as EXCEL and then graphs, charts etc can be produced using the graphing capabilities of the spreadsheet program.

The Magnum supports 1008 History Samples for all inputs & outputs.

By adding the MCS-COMPACT (which uses Flash 2G cards) to the Magnum this increases the storage history up to a year+ of run data.

### 11.1.4 Print Graph

Prints the current Graph on the screen.

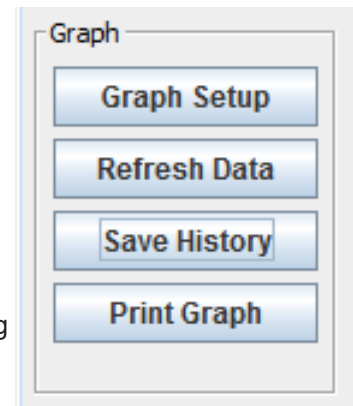

## Chapter - 12. Diagnostic Save 'EASY BUTTON'

### 12.1. Diagnostic Save

Clicking on 'DIAGNOSTIC SAVE' allows the users to save files which can be viewed in a txt program such as Notepad or better yet in Excel.

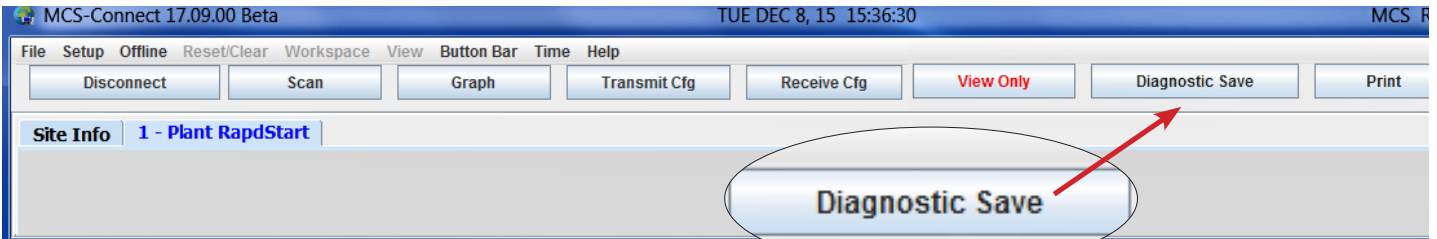

The screen on right appears alerting the user that MCS-CONNECT is ready to perform a diagnostic save of the unit that is being monitored.

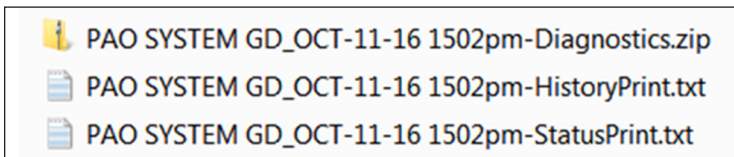
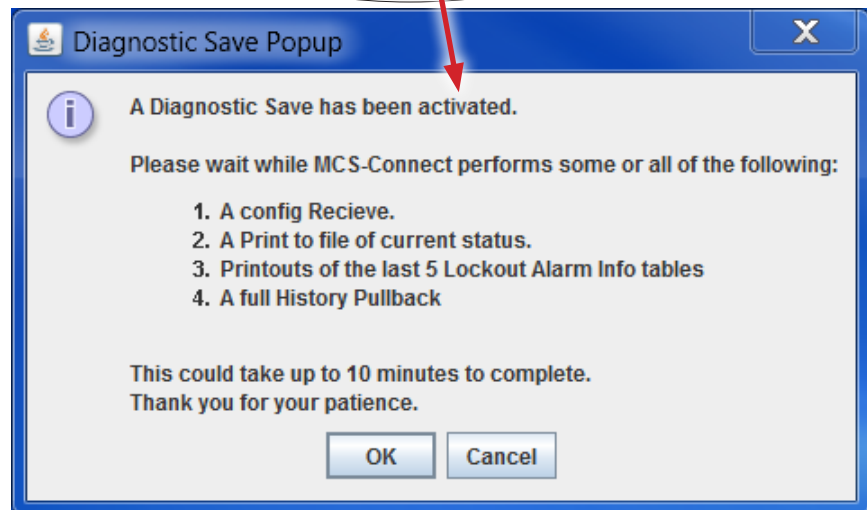

**Saves a Zip file to your computer and can Auto Email zip file to: [support@mcscontrols.com](mailto:support@mcscontrols.com)**

***'The Easy Button'***  
**for MCS-CONNECT**

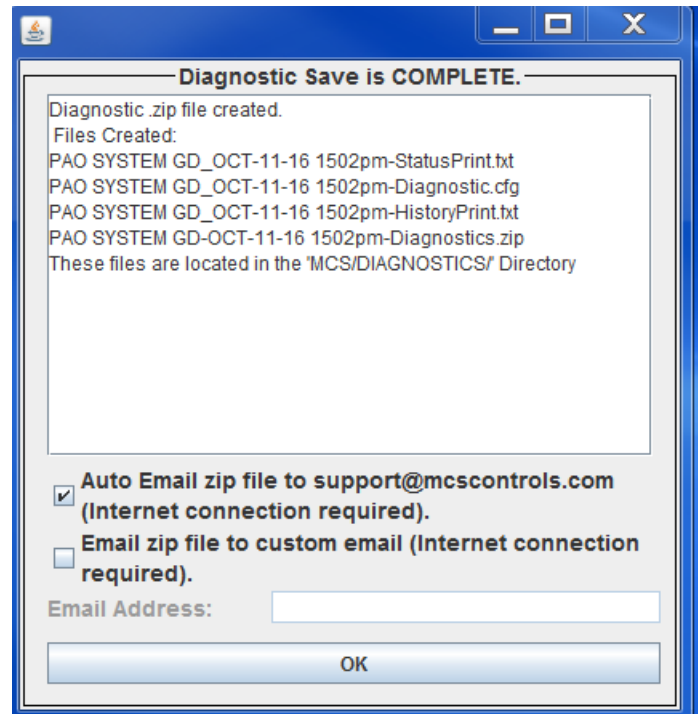

## Chapter - 13. MCS-RTU MODES OF OPERATIONS

The MicroMag RTU firmware allows support of the following HVAC modes of operations:

Mode	Description
Cooling	Types of Cooling supported are staged DX, Modulating Chilled Water & ON/OFF Chilled Water
Heating	Supports Staged Gas, Modulating Gas (using Modgas II Controller, ON/OFF Hot Water, Modulating Hot Water, Modulating SCR Electric & Heat Pump
Ventilation	Only available in occupied mode and setup for continuous supply fan and no call for Heating or Cooling
Dehumidification	Enabled based on indoor air humidity set point and requires a zone or return air humidity sensor
Off	The Unit can be OFF if in Unoccupied mode with no call for Heating, Cooling or Dehumidification

### 13.1. MicroMag Scheduling

The MicroMag software consists of the following scheduling capabilities:

Schedule Type	Description
Weekly	Two (2) Start/Stop schedules per day
Holidays	Scheduling for 8 holidays with two (2) Start/Stops

### 13.2. MicroMag Occupied Mode

The MicroMag software determines occupied mode based on four (4) possible inputs:

Sensor	Description
Schedule	Based on an internal weekly schedule or holiday schedule
Remote Input	A BMS system providing a hard wired contact closure
Override Button	An override input from a Zone sensor or from a communicating Thermostat
BMS Communications	BMS communications (BACnet, Modbus, Lontalk)

### 13.3. MicroMag Unoccupied Mode

The MicroMag software determines unoccupied mode based on the four (4) possible Occupied inputs described above. The following actions are taken:

MCS Item	Description
Night Setback	Night setback set points will be applied to the cooling and heating enable set points. If schedule control is set to ON/OFF the unit will shut off
Dehumidification Set Point	If night humidity control is requested the dehumid set points will be used
Outdoor Air Damper	Outside Air Damper remains closed unless the unit is in free cooling mode, or the damper is open during occupied
Unit Off	If no call for cooling, heating or dehumidification the unit will be off due to no demand.

### 13.4. MicroMag Ventilation Mode

The MicroMag firmware support of the Ventilation mode:

Options	Description
Occupied	The unit must be in Occupied mode
Heat	The unit must not be calling for Heating
Cooling	The unit must not be calling for Cooling
Dehumidification	The unit must not be calling for Dehumidification

### 13.5. MicroMag OFF Mode

The MicroMag firmware support of the OFF mode:

Mode	Description
Unoccupied	The unit must be in Unoccupied mode
Supply Fan	The Supply fan is OFF and outside Air Damper is closed
Exception	If night humidity control is requested

### 13.6. MicroMag Proof of Flow

The MicroMag firmware support of the Proof of Flow:

Options	Description
Proof of Flow switch	Interlock dry contact switch, optional part to order or provided by others, uses 5 vdc from MicroMag

### 13.7. MicroMag Dirty Filter Status

The MicroMag firmware support of the Dirty Filter Status:

Options	Description
Dirty Filter Status	Interlock dry contact switch, optional part to order or provided by others, uses 5 vdc from MicroMag

### 13.8. MicroMag Smoke Detector

The MicroMag firmware support of the Smoke Detector:

Options	Description
Smoke Detector	Interlock dry contact switch, provided by others, uses 5 vdc from MicroMag, shuts HVAC OFF. Generates Alarm

### 13.9. MicroMag Air to Air Heat Pump Operation

The MicroMag firmware supports Air to Air Heat Pump Operation:

Options	Description
Reversing Valve	A common relay output must be configured with the compressor to allow the system to set the compressor in either heating or cooling
Auxiliary Heating Stages	Can be the following: <ul style="list-style-type: none"> <li>• Modulating SCR Electric</li> <li>• Modulating Heat Wheel</li> <li>• Stages of Electric Heat</li> <li>• Modulating Reheat</li> <li>• Modulating or ON/OFF Combustion Modules</li> </ul>

### 13.10. MicroMag Warning Notification

The MicroMag firmware supports both Warnings and Alarms. There are adjustable set points for all functions. If the circuit trips it goes into a safety the first time. If it fails twice on the same circuit and the same failure within 2 hours the circuit locks out. A manual Lockout/Reset is required. Alarms are posted in the Alarm List.

- The last 100 Warnings/Alarms are available to view via the 2 x 16 MicroMag display.
- Alarms can be viewed via MCS-CONNECT from a PC.
- An Alarm relay out is available so alarm notification can notify someone remotely.

Options	Description
Warnings	Warnings are potential failures in which the MicroMag is taking corrective action <ul style="list-style-type: none"> <li>• Low Suction PSI (Requires Suction Pressure Transducer)</li> <li>• Hi Discharge PSI (Requires Suction Pressure Transducer)</li> <li>• Low suction Temp (Requires Suction Temp Sensor per circuit)</li> <li>• Hi Discharge Temp (Requires Discharge Temp sensor per circuit)</li> <li>• Low Amp/No Start (Requires amp sensor per circuit)</li> <li>• Information Sensor failures</li> </ul>

### 13.11. MicroMag Alarm Notification

The MicroMag firmware supports both Warnings and Alarms. There are adjustable set points for all functions. If a warning fails twice on the same circuit and same failure within 2 hours the circuit locks out. A manual Lockout/Reset is required. Critical failures go into alarm immediately.

- Alarms are posted in the Alarm List. The last 100 Alarms are available to view via the 2 x 16 MicroMag display.
- Alarms can be viewed via MCS-CONNECT from a PC.
- An Alarm relay out is available so alarm notification can notify someone remotely.

Options	Description
Alarms	<ul style="list-style-type: none"> <li>• Unsafe suction (Requires Suction Pressure Transducer)</li> <li>• All critical Sensor failures required for control.</li> <li>• Information Sensor failures</li> <li>• The 2<sup>nd</sup> time the following failures occur within 2 hours (User settable):</li> <li>• Low Suction PSI (Requires Suction Pressure Transducer)</li> <li>• Hi Discharge PSI (Requires Suction Pressure Transducer)</li> <li>• Low suction Temp (Requires Suction Temp Sensor per circuit)</li> <li>• Hi Discharge Temp (Requires Discharge Temp sensor per circuit)</li> <li>• Low Amp/No Start (Requires amp sensor per circuit)</li> </ul>

### 13.12. MicroMag Lockout Alarm Information

The MicroMag firmware supports detail information on Alarms that cause a lockout:

Options	Description
Lockout Alarm	The most current four (4) Alarms will have associated with the Alarm the last 15 seconds of all data prior to the lockout

### 13.13. MicroMag Zone Temperature/Humidity Mode

The MicroMag firmware support of the Zone Temperature/Humidity mode:

Options	Description
MCS-ZONE	Zone Temperature sensor, connects via 2 wire shielded cable to MicroMag
MCS-HUMD	Zone Temperature sensor and Humidity sensor, connects via 5 wire shielded cable to the MicroMag
MCS-HUMD-OVERRIDE	Zone Temperature sensor and Humidity sensor, connects via 5 wire shielded cable to the MicroMag. It has an override button that allows the unit to be placed in occupied mode for the time specified in the Override set point.
Target Reset	A Target Reset set point is available to reset target during unoccupied mode.

### 13.14. MicroMag Duct Static Pressure Control

The MicroMag firmware support for Duct static Pressure:

Options	Description
MCS-STATIC-5	Must have a static sensor that supplies 0 to 5 vdc signal to MicroMag based on current duct static pressure. Optional part to order or provided by others, uses 5 vdc from MicroMag
Supply Fan Control	Must have a VFD for the supply fan to allow modulating fan speed.
Dirty Filter Control	As the return air filters get dirty the system will speed up the fan to maintain a constant supply pressure.
Zone Target Control	When the zone target is reached the MicroMag will slow down the supply fan to maintain temperature.
Supply Target Control	When the supply fan slows the supply temperature will decrease. If an optional modulating supply water valve is supplied the MicroMag will slow down the chilled water supply input to maintain supply temperature.

### 13.15. MicroMag BMS Support

The MicroMag firmware supports the following BMS Systems. (Please refer to the MicroMag manual for complete details):

Options	Description
BACnet MSTP	The MicroMag supports BACnet MSTP. Currently the OEM allows writing to 18 set points.
Modbus RTU	The MicroMag supports Modbus RTU. Currently the OEM allows writing to 18 set points.
BACnet IP	Requires and MCS-BACnet Router2
Lontalk	Requires and MCS-Lontalk-Adapter



### 13.16. MicroMag Keypad/Display

The MicroMag firmware supports an on board Keypad/Display. For detailed information refer to the MicroMag Manual.

Options	Description
Keypad	The MicroMag supports an on board six (6) button Key Pad as follows: <ul style="list-style-type: none"> <li>• Menu Key</li> <li>• Enter Key</li> <li>• ↑ Up Arrow</li> <li>• ↓ Down Arrow</li> <li>• → Right Arrow</li> <li>• ← Left Arrow</li> </ul>
Display	The MicroMag support an on board 2 x 16 backlit display

### 13.17. MicroMag Data Trending

The MicroMag firmware supports the storage of ALL INPUTS & OUTPUTS for trending both Static and Dynamic.

Options	Description
Static Trending	The MicroMag supports Static Trending as follows: The most current 300 samples Selective sample time. (At Config time or real time via MCS-CONNECT Use MCS-CONNECT to retrieve the Static Trending date and plot in graph format.
Dynamic Trending	With MCS-CONNECT you can select Dynamic graphing. (Sec. by Sec.)

### 13.18. MicroMag Cooling Mode

The MicroMag firmware supports the following cooling functions:

Options	Description
Cooling with Scroll Compressors	Options are Staged DX, Modulating Chilled Water and ON/OFF Chilled Water Up to 4 stages of cooling can be defined with up to 4 steps on each stage. (Hot Gas bypass, unloaders) Anti Cycle set points, OFF to ON and ON to ON are provided. (On to ON regulates the maximum number of starts per hour the compressor can have) Cooling is enabled when the zone temperature rises above the set point plus the control zone.
Cooling without Digital Scroll Compressors	Once in cooling mode the system will modulate the cooling capacity, (by adding or removing fixed steps of cooling) to maintain the Supply Air Target set point. Chilled Water control will modulate the chilled water return liquid valve to maintain supply air temperature.
Cooling with Digital Scroll Compressors	The MicroMag has a built in Digital scroll controller to control the first Digital Scroll. Additional digital scrolls can be controlled by adding and MCS-DIGITAL-SCROLL-INTERFACE for each Digital Scroll controlled via an Analog Output from the MicroMag.

### **13.19. MicroMag Heating Mode**

The MicroMag firmware supports the following heating functions as follows:

- Direct Fire
- Mod Gas
- Hot Water/Steam Valve
- Staged/Modulating Gas
- Staged/Modulating Electric

### **13.20. MicroMag Dehumidification Mode**

The MicroMag firmware supports the following dehumidification functions as follows:

- Cool/Heat Demand
- Sup Duct Prs
- Disc PSI 1
- Disc PSI 3
- Suct PSI 2

## Chapter - 14. MCS-CONFIG

The following options are specified in MCS-Config when building the configuration for the controller.

These options are used by the MCS or an OEM to customize the system to meet the individual control requirements.

### 14.1. General Options

- Control method is based upon a control zone.
- The control temperature sensor can be either the Entering or Leaving sensor.
- Condenser control maintaining sufficient discharge superheat for good oil separation.
- Anti-cycle timers (OFF to ON and ON to ON).
- Maximum of 6 circuits per MicroMag, with selectable compressor rotation.
- Warning RO (turned on for low suction unload, high discharge unload, etc.).
- Alarm RO (turned on whenever an alarm is generated).
- Optional auto rotation for compressors.
- Low and/or high ambient temperature shut down.

### MicroMag-V18 Setup Screen

Default LCD Display	UNIT STATUS	Total Number of RO's	6	◀▶	Spare ROs
Default Display Point		Total Number of AO's	4	◀▶	Spare AOs
Display Units	Deg F / PSI	Total Number of SI's	10	◀▶	Spare SIs
Max Lockout Resets per Day	6	MCS-Thermostat <input type="radio"/> Yes <input checked="" type="radio"/> No			
Auth Level Bypass	Factory Level	Number of SI Boards			
History Sample Rate (Seconds)		120		<input checked="" type="radio"/> Auto <input type="radio"/> Zero <input type="radio"/> One <input type="radio"/> Two	

<u>Daylight Savings Time</u>			Spring Forward Month	March
Daylight Savings Time Active	<input checked="" type="radio"/> Yes <input type="radio"/> No	Reset to U.S.A Daylight Savings	Spring Forward Begin Date	8
Daylight Savings Time DOW	Sunday		Spring Forward End Date	14
Daylight Savings Time Hour	2		Fall Back Month	November
			Fall Back Begin Date	1
			Fall Back End Date	7

<u>RS485 Communication #1</u>			<u>RS485 Communication #2</u>		
MCS Protocol Address	1	◀▶	MCS Protocol Address	1	◀▶
Protocol Type	MCS		Protocol Type	MCS	
Baud Rate	19200		Baud Rate	19200	

<u>RS485 Config-Loss of BMS Communication</u>					
Network Run/Stop Default			Network Schedule Default		
<input checked="" type="radio"/> Stop	<input type="radio"/> Run	<input type="radio"/> No Change	<input type="radio"/> Unoccupied	<input type="radio"/> Occupied	<input checked="" type="radio"/> Schedule

<u>System Graphic Information</u>	
Name of Graphic file :	C://MCS/Graphics/

### 14.1.1 DEFAULT LCD DISPLAY

- Scrolling Info LCD Display: When setup in the configuration file, the LCD will continue to display the status points of the controller you are viewing. After pressing a button, the scrolling will pause for 15 minutes before it continues.

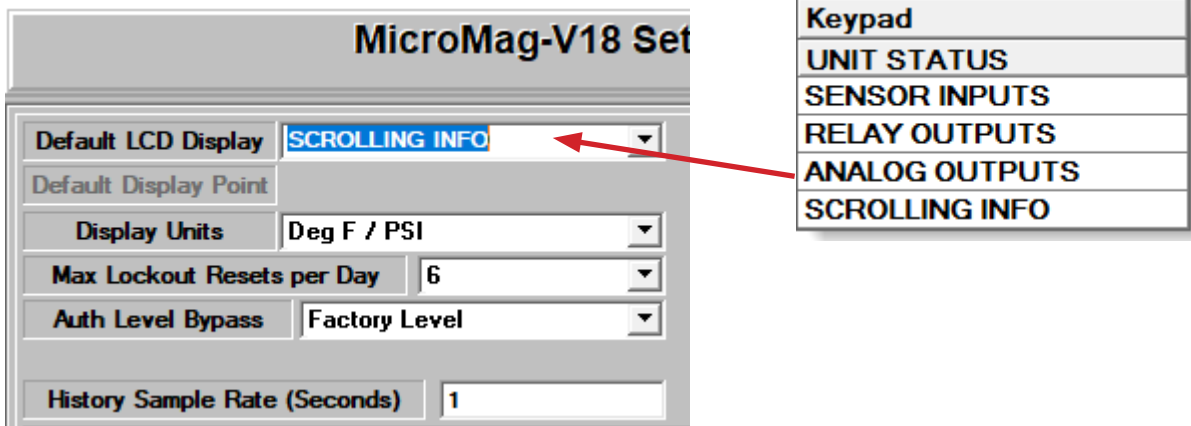

### 14.1.2 SETUP EXPANSION BOARDS / THERMOSTAT

Section shows the total number of RO's, AO's and SI's used including all expansion boards.

Spare keys above allows the user to clear the contents of a row in the ROs, AOs, & SIs screen.

- MCS-THERMOSTAT - click YES if you have a MCS-THERMOSTAT installed in your system

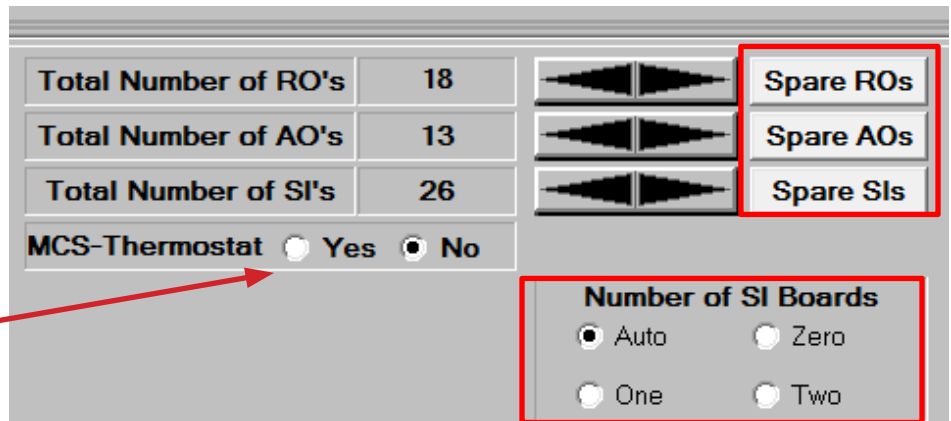

### 14.1.3 DAYLIGHT SAVING TIME

Setup for entering Daylight saving time.

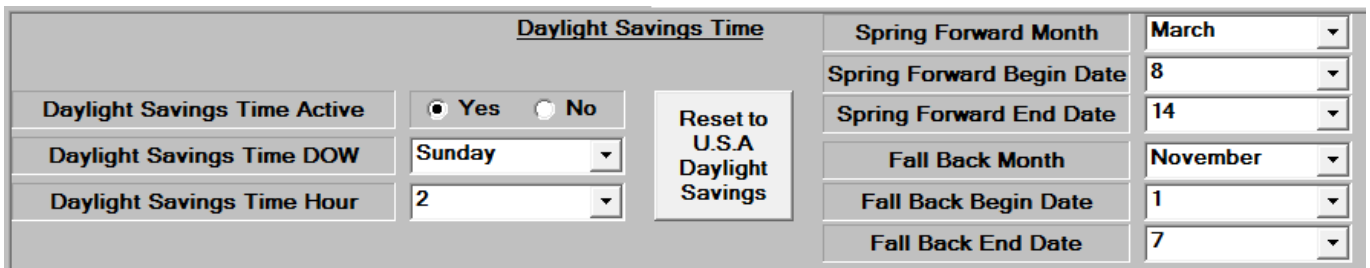

## 14.2. MicroMag MCS-Config

The MicroMag control is a function of the items selected during construction of the cfg. Shown below is the MicroMag RTU Information Screen.

### 14.2.1 General Info

The sensors are selected that will control the following modes:

-Ventilation Mode    -Cooling Mode    -Heating Mode    -Dehumidification Mode

### MicroMag-V18 Information Screen

**Information Panel Selector**  
 Chiller     **RTU**     AHU

**General Info**     Ventilation Info     RTU     Cooling Info     Heating Info

#### General Information

<p><b>Control Mode On:</b>    Return    Supply    Zone    Ambient</p> <p><b>Ventilation Mode</b>    <input type="radio"/>    <input checked="" type="radio"/>    <input type="radio"/>    <input type="radio"/></p> <p><b>Cooling Mode</b>    <input type="radio"/>    <input checked="" type="radio"/>    <input type="radio"/>    <input type="radio"/></p> <p><b>Heating Mode</b>    <input type="radio"/>    <input checked="" type="radio"/>    <input type="radio"/>    <input type="radio"/></p> <p><b>Dehumid Mode</b>    <input type="radio"/>    <input checked="" type="radio"/>    <input type="radio"/>    <input type="radio"/></p> <p>Calculated Reset Sensor Not Used</p>	<p style="text-align: center;"><b>Supervisory Controls</b></p> <p>Mode Selection    <input type="radio"/> On    <input checked="" type="radio"/> Off</p> <p><input type="radio"/> None    <input checked="" type="radio"/> Forced Staging    <input type="radio"/> Forced Mode</p>	<p style="text-align: center;"><b>Schedule Control</b></p> <p><input checked="" type="radio"/> Occupation State <input type="radio"/> On/Off</p>																												
<p style="text-align: center;"><b>Unit Sensors</b></p> <table border="1" style="width: 100%; border-collapse: collapse;"> <tr> <td>Supply Temp. S/A Temp</td> <td>Outside Temp. O/A Temp</td> <td>Return Temp. Not Used</td> </tr> <tr> <td>Supply Humidity Not Used</td> <td>Outside Humidity Spare1-14</td> <td>Smoke Alarm Indic. Not Used</td> </tr> <tr> <td>Zone/Space Humidity Not Used</td> <td>Outside Enthalpy Not Used</td> <td>Return Humidity Not Used</td> </tr> <tr> <td>Zone/Space Temp. Not Used</td> <td>Air Flow Switch AirFlow</td> <td>Clogged Filter Indic. Not Used</td> </tr> <tr> <td>Drain Pan Condensation Alarm Not Used</td> <td>Fire Alarm Indic. Not Used</td> <td></td> </tr> </table>	Supply Temp. S/A Temp	Outside Temp. O/A Temp	Return Temp. Not Used	Supply Humidity Not Used	Outside Humidity Spare1-14	Smoke Alarm Indic. Not Used	Zone/Space Humidity Not Used	Outside Enthalpy Not Used	Return Humidity Not Used	Zone/Space Temp. Not Used	Air Flow Switch AirFlow	Clogged Filter Indic. Not Used	Drain Pan Condensation Alarm Not Used	Fire Alarm Indic. Not Used		<p style="text-align: center;"><b>Cooling/Heating</b></p> <table border="1" style="width: 100%; border-collapse: collapse;"> <tr> <td>Stage 1 Enable StgEnbl 1</td> <td>Stage 2 Enable StgEnbl 2</td> </tr> <tr> <td>Stage 3 Enable Not Used</td> <td>Stage 4 Enable Not Used</td> </tr> <tr> <td>Stage 5 Enable Not Used</td> <td></td> </tr> <tr> <td>Cool/Heat Demand SI C/Ht Dmnd</td> <td>Heat Enable SI Heat Enbl</td> </tr> <tr> <td>Additional Enable SI Not Used</td> <td>Additional # of SIs 0</td> </tr> </table> <p style="text-align: center;"><b>Evaporator Fan</b></p> <table border="1" style="width: 100%; border-collapse: collapse;"> <tr> <td>Fan Enable SI Not Used</td> <td>Fan Demand SI Not Used</td> </tr> </table> <p style="text-align: center;"><b>Dehumidification</b></p> <table border="1" style="width: 100%; border-collapse: collapse;"> <tr> <td>Demand/Enable SI DehumDmnd</td> </tr> </table>	Stage 1 Enable StgEnbl 1	Stage 2 Enable StgEnbl 2	Stage 3 Enable Not Used	Stage 4 Enable Not Used	Stage 5 Enable Not Used		Cool/Heat Demand SI C/Ht Dmnd	Heat Enable SI Heat Enbl	Additional Enable SI Not Used	Additional # of SIs 0	Fan Enable SI Not Used	Fan Demand SI Not Used	Demand/Enable SI DehumDmnd	<p style="text-align: center;"><b>Target Reset Sensors</b></p> <p>Cooling Target Reset Not Used</p> <p>Heating Target Reset Not Used</p> <p>Reheat Target Reset Not Used</p> <p style="text-align: center;"><b>Unit Indicators</b></p> <p>Warning Relay Not Used</p> <p>Alarm Relay Alarm</p> <p>Lockout Reset Switch Not Used</p> <p style="text-align: center;"><b>Unit Power</b></p> <p>Phase Loss Not Used</p>
Supply Temp. S/A Temp	Outside Temp. O/A Temp	Return Temp. Not Used																												
Supply Humidity Not Used	Outside Humidity Spare1-14	Smoke Alarm Indic. Not Used																												
Zone/Space Humidity Not Used	Outside Enthalpy Not Used	Return Humidity Not Used																												
Zone/Space Temp. Not Used	Air Flow Switch AirFlow	Clogged Filter Indic. Not Used																												
Drain Pan Condensation Alarm Not Used	Fire Alarm Indic. Not Used																													
Stage 1 Enable StgEnbl 1	Stage 2 Enable StgEnbl 2																													
Stage 3 Enable Not Used	Stage 4 Enable Not Used																													
Stage 5 Enable Not Used																														
Cool/Heat Demand SI C/Ht Dmnd	Heat Enable SI Heat Enbl																													
Additional Enable SI Not Used	Additional # of SIs 0																													
Fan Enable SI Not Used	Fan Demand SI Not Used																													
Demand/Enable SI DehumDmnd																														
<p style="text-align: center;"><b>Unit Control</b></p> <table border="1" style="width: 100%; border-collapse: collapse;"> <tr> <td>Run/Stop Switch Spare1-9</td> <td>Emergency Stop Switch Not Used</td> <td>Thermostat Run/Stop Not Used</td> <td>Post Alarm When Run/Stop Switch Set to Stop? <input checked="" type="radio"/> Yes    <input type="radio"/> No</td> </tr> </table>			Run/Stop Switch Spare1-9	Emergency Stop Switch Not Used	Thermostat Run/Stop Not Used	Post Alarm When Run/Stop Switch Set to Stop? <input checked="" type="radio"/> Yes <input type="radio"/> No																								
Run/Stop Switch Spare1-9	Emergency Stop Switch Not Used	Thermostat Run/Stop Not Used	Post Alarm When Run/Stop Switch Set to Stop? <input checked="" type="radio"/> Yes <input type="radio"/> No																											
<p style="text-align: center;"><b>Generator</b></p> <table border="1" style="width: 100%; border-collapse: collapse;"> <tr> <td>Generator Switch Not Used</td> <td>Max Cooling Stages 0</td> <td>Max Dehumid Stages 0</td> <td>Max Heating Stages 0</td> <td>Aux Heating Allowed <input type="radio"/> Yes    <input checked="" type="radio"/> No</td> </tr> </table>			Generator Switch Not Used	Max Cooling Stages 0	Max Dehumid Stages 0	Max Heating Stages 0	Aux Heating Allowed <input type="radio"/> Yes <input checked="" type="radio"/> No																							
Generator Switch Not Used	Max Cooling Stages 0	Max Dehumid Stages 0	Max Heating Stages 0	Aux Heating Allowed <input type="radio"/> Yes <input checked="" type="radio"/> No																										

The following info and sensors are selected:

- Dehumid cooling control
- Unit Indicators – Warning & Alarm Outputs.
- Unit Control – RUN/STOP Input.
- Unit Power – Phase loss Input.

53

The following Unit Sensors are setup:

- Supply & Return Temp. & Humidity.
- Ambient Temp & Humidity.
- Air Flow sensor
- Smoke sensor if available
- Air Flow sensor
- Fire Alarm Sensor if available

**14.2.2 Ventilation Info**

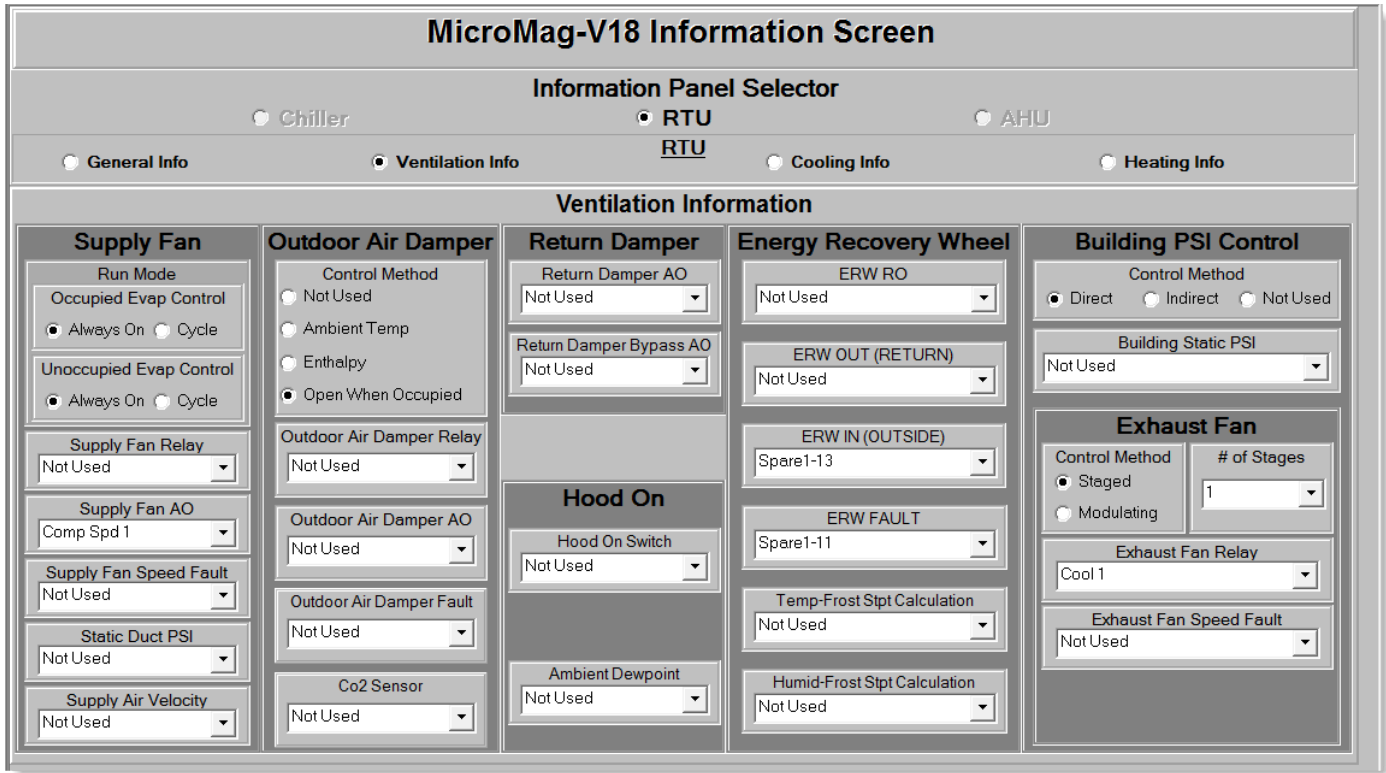

The following areas are specified in the Ventilation section:

- **Supply Fan**
  - Type Control
  - Supply Fan Relay
  - Supply Fan AO
  - Supply Fan Sped Fault
  - Static Duct PSI
  - Supply Air Velocity
- **Outdoor Air Damper**
  - Supply Fan Run Mode
  - Outdoor Air Damper Relay
  - Outdoor Air Damper Fault
  - Co2 Sensor
- **Return Damper**
  - Control Method
  - Hood On
  - Ambient Dewpoint
- **Energy Recovery Wheel**
  - ERW RO
  - ERW OUT (RETURN)
  - ERW IN (OUTSIDE)
  - ERW FAULT
  - Temp-Frost Stpt Calculation
  - Humid-Frost Stpt Calculation
- **Building PSI Control**
  - Control Method
  - Building Static PSI
- **Exhaust Fan**
  - Control Method # of Stages
  - Exhaust Fan Relay
  - Exhaust Fan Speed Fault

### 14.2.3 Cooling Info

## MicroMag-V18 Information Screen

Information Panel Selector

Chiller    
  **RTU**    
  AHU

General Info    
  Ventilation Info    
  **RTU**    
  Cooling Info    
  Heating Info

### Cooling Information

# of Compressors:

# of Steps:

Refrigerant Type:

Pre-Pump Out:  Yes  No

Last Stage to 100% (Override Setpoint):  Yes  No

Wanted %-Starting Next Compressor:  Calculated %  Use Min %

Lockout Unit When Any Compressor Enters a Safety or Locks Out?:  Yes  No

#### Preliminary Cooling

Pre-Cool RO:

Pre-Cool AO:

Pre-Cool and Condenser CHW Line Sharing:  On  Off

Pre-Cool Control SI:

#### Common Reheat Outputs

Use Common Reheat RO?:  Yes  No

Use Common Reheat AO?:  Yes  No

#### Reheat Capacity

Increase Reheat Capacity When Below Target?:  Yes  No

#### Dehumidification

Enable Dehumidification:  Yes  No

Dewpoint Sensor:

Number of Cool Stages:

Dehumid Enable SW:

#### Heating

Allow Primary/Auxiliary Heat During Dehumidification?:  Yes  No

#### Compressors

Force Compressors on When in Dehumidification?:  Yes  No

Reheat Ctrl on Supply Temp?:  Yes  No

Reheat Ctrl SI:

- Specify number of compressors
- # of Steps
- Refrigerant Type
- Pre-Pump Out

- Preliminary Cooling
- Common Reheat Outputs
- Reheat Capacity

- Dehumidification
- Heating
- Compressors

55

## 14.2.4 Heating Info

**MicroMag-V18 Information Screen**

**Information Panel Selector**  
 Chiller     **RTU**     AHU

General Info     Ventilation Info     **RTU**     Cooling Info     **Heating Info**

**Heating Information**

**Heating**

Heat Pump  
 Yes     No

Heater Fault  
 Not Used

Morning Warmup RO  
 Not Used

**Primary**

Heat Type  
 Direct Fire  
 MOD Gas  
 Hot Water / Steam Valve  
 Staged / Modulating Gas  
 Staged / Modulating Electric  
 Not Used

MOD Gas Fault  
 Not Used

Ignition Indicator  
 S/A Temp

Number of Valves  
 1

**Auxiliary**

Heat Type  
 Hot Water / Steam Valve  
 Staged / Modulating Gas  
 Staged / Modulating Electric  
 Not Used

Staged Electric Fault  
 Not Used

Starting RO  
 Not Used

AO  
 Not Used

Number of Stages  
 1

**Preheat**  

Preheat RO  
 Not Used

Preheat AO  
 Not Used

Preheat SI  
 Not Used

**Gas Valves on the RTU**

Valve # (reset button)	Low Fan RO	High Fan RO	MOD Valve AO
▶ 1 ...	Not Used	Not Used	Heat Dmnd 1
2 ...	Not Used	Not Used	Not Used
3 ...	Not Used	Not Used	Not Used
4 ...	Not Used	Not Used	Not Used

■ **Heating**

- Heat Pump
- Morning Warmup RO

■ **Preheat**

- Preheat RO
- Preheat AO
- Preheat SI

■ **Primary**

- Heat Type
- MOD Gas Fault
- Ignition Indicator
- Number of Valves

■ **Gas Valves on the RTU**

■ **Auxiliary**

- Heat Type
- Staged Electric Fault
- Starting RO
- AO
- Number of Stages



## Chapter - 15. CONTROL OPERATIONS

### 15.1. Control Modes

- Evaporator Mode
- Cooling Mode
- Heating Mode
- Dehumidification Mode

### 15.2. Power up

If the unit is not in a LOCKOUT condition, it will start in the Power Up stage. After completing this stage the supply fan will be started. The fan will start and no other functions can be initialized until flow has been established and the minimum supply startup time has passed.

### 15.3. Determine Building mode

The system will determine if the building is occupied or unoccupied. The configuration file can be setup to use a schedule or an input to indicate occupied status. If unoccupied the night setback Setpoints will be applied. To view the current status you can do the following:

#### 15.3.1 From MicroMag Display:

- Press 'MENU' button
- Press 'ENTER' button
- Press 'RIGHT' button twice

#### 15.3.2 From your laptop using MCS-CONNECT:

- Using MCS-CONNECT connect to the MicroMag using the RS 485 port
- If multiple units, select tab for this MicroMag and you will get a status display
- In the control section, of the status display, in UNIT STATE is under MODE

### 15.4. Determine Unit mode

The setting of the unit mode will enable the cooling, heating or dehumidification functions to be executed. The setting of the control mode will be based on the control sensor for the Ventilation Mode. The following modes can be identified:

#### 15.4.1 OFF

The Unit Mode will be OFF if the unit has experience a safety condition resulting in a LOCKOUT or the unit RUN/STOP indicates a STOP.

#### 15.4.2 Cooling Mode

When the control sensor for the Ventilation Mode is above the value of Setpoint #1, Enable Cooling, the mode will be set to COOLING MODE. In this mode the cooling functions will be enabled. The control sensor provides the temperature data that has been selected in the Cooling Mode in the General Info section of the RTU Information Screen. If free cooling (economizer) has been specified and the ambient conditions allow, it will be used before mechanical cooling. (It is considered a stage of cooling.) The staging of the cooling steps is based on the same integration routine with ROC override as used in the Magnum. The unit will stay in this mode until the Ventilation Mode control temperature drops below the value of Setpoint #1 minus its low zone value. If this is an outside air makeup unit and auto temperature reset has been selected in the config then the supply temperature will be modulated based on the change in the zone temperature. The unit will enter a SWITCHING state when the system is leaving the cooling mode. If the humidity is high at this point and the system is entering the VENT ONLY mode any compressors that are on will remain on in anticipation of entering the DEMUNIDITY mode; else all steps will be staged off.

### 15.4.3 Heating Mode

When the control sensor for the Ventilation Mode is below the value of Setpoint #2, 'Enable Heating' the mode will be set to HEATING MODE. If a heat pump is available the mode will be set to 'HP ONLY'. In this mode the reversing valve is turned based on Setpoint 92. After the time specified in Setpoint 92 the compressor will be started. If the compressor is a modulating unit it will be adjusted until it reaches 100% of capacity. The control sensor provides the temperature data that has been selected in the Heating Mode in the General Info section of the RTU Information Screen. When at 100% an additional capacity is available it will be started. If the next stage is a combustion module please refer to that section for startup sequence.

For non-heat pump systems the first stage of heating will be activated. If staged type of heating the stages will be added as heating is needed. Once a heating step is turned on a minimum on time can be specified in the ROs information screen if needed, default is 0 time. If stage 1 is a variable type of heating the associated analog output will be modulated to maintain the heating Setpoint value. If additional heating is required and stage 1 is at its maximum then stage 2, if available, will be enabled. If less heating is required the system will unload all heating steps in stage 2 prior to unloading stage 1.

For a heat pump system the first stage of heating will be the heat pump with the reversing valve on if the ambient conditions are met. The second stage of heating can be used if additional heating is required. The emergency heating, if specified, can only be used if the heat pump is not functioning as the first stage of heating.

The unit will stay in this mode until the Ventilation Mode control temperature rises above the value of Setpoint #219 plus its high zone value. The unit will enter a SWITCHING state when the system is leaving the heating mode if any heating stages are on.

### 15.4.4 Vent Mode

When the control sensor for the Ventilation Mode is below the value of Setpoint #1 minus its low zone value and above the value of Setpoint #2 plus its high zone the VENT ONLY mode will be entered. This indicates that neither heating nor cooling is required. When in this mode and the Dehumid Mode sensor is greater than Setpoint #3, this Setpoint must be active, the DEHUMIDITY mode will be entered.

### 15.4.5 Dehumidification Mode

The dehumidification mode will use the number of cooling stages specified in the config to cool the air and the circuit-reheat function to heat the air if necessary to remove the humidity. The cooling state will be set to DEHUMID-COOL and the cooling stages will be staged on up to the number indicated in the Dehumidification Section. Note a compressor must be associated with a suction group that has reheat capabilities; refer to the Circuit Base screen, to be turned on.

If the control temperature is less than the value of Setpoint #1 the reheat function of all circuits that are on will be used to increase the control temperature.

For systems with multiple compressors per suction group, a compressor will be turned off or not allowed to be turned on if a low suction condition exists for that circuit. This is accomplished by using the High SI Off sensor in the Circuit SI screen.

The system will stay in this mode until the humidity decreases below the value of Setpoint 3 minus its low zone or heating or cooling is required.

## 15.5. Combustion Module Control

The following is the startup sequence of a modulating gas heat combustion module.

### 15.5.1 Ignition

- The high speed blower is turned on
- The gas is turned on at 100%
- When the supply temperature increases by more than the value in set

Point 100 (IGN SAFETY) the unit is moved to the Warm Up State. If we do not reach this within the time allotted in Setpoint 100 we go into a safety. We will then wait for the safety time and try a second time. If we fail a second time we will lockout this combustion module.

### 15.5.2 Warm up

We will remain in the Warm Up state for the time specified in Setpoint 101

### 15.5.3 Heating

- After warm up the unit will be set to low blower speed and 10% gas.
- If additional capacity is required the gas will be increased.
- When the gas % is greater the Setpoint 107 the blower is moved to high Speed. At 40%, if additional stages are available they are brought on and the modulating units return to 10% and low speed. If all stages are on and additional capacity is required the modulating units are increased to 100% as required. (This sequence is followed because it is the most energy Efficient.

## 15.6. Override Button

The override button is usually mounted on the right side of the Zone temperature sensor housing. When in unoccupied mode (Scheduled off) and there is a need to go to occupied mode pressing the override button for 1 to 2 seconds shifts the unit back to the occupied mode for the time specified in Setpoint #36. (Override min)

## 15.7. Resets

There are three types of resets in the MicroMag, as follows:

### 15.7.1 MAX RESET (Setpoint #99)

This reset is inputted from the user. It can be a 0 to 5 vdc signal wired to a sensor input or a BMS communicated.

### 15.7.2 MAX CALC RESET (Setpoint #109)

If this Setpoint is active the MicroMag will vary the supply temperature proportionally, up or down to try to maintain the zone target.

### 15.7.3 USER RESET (Setpoint #110)

If this Setpoint is active the MicroMag will do the following:

- A momentary push button switch, located on the left side of the zone temperature sensor will make a temporary change to the Mode enable & supply air Setpoints. At midnight the values are set back to their regular values.
- When pressed for less than 3 sec it will lower the mode Setpoints by the value in the adjust Setpoint. This can be repeated until the max adjustment has been reached in the Setpoint.
- When pressed for greater than 5 sec it will increase the mode Setpoints by the value in the adjust Setpoint. This can be repeated until the max adjustment has been reached in the Setpoint.

## 15.8. Modbus RTU

The Modbus RTU address can be verified and changed (with the proper authorization code) from the keypad/LCD. The following steps will display the Modbus RTU Network address, and the Baud Rate:

- Press the Menu key, select Serv Tools, and then press the Enter key.
- Select RS485 Network then press Enter.
- Select Protocol then press Enter. Change the protocol to Modbus.

- Select address then press Enter. Change the address then press Enter.
- Select Baud then press Enter. Set the baud rate then press Enter.
- Connect the communication wires to the TX RS485 three position portion of the six position terminal block located above the display.

## ADDITIONAL DATA TO BE ADDED

### 15.9. Network inputs to MicroMag

The MicroMag can receive changes from the network to enable or disable the Network Run/Stop & Network Target Reset.

The MicroMag has a large number of Setpoints that can be written to from the BMS. They are identified in the Setpoint chart in this section.

**Net Run/Stop** – Does not need a virtual SI or to be pointed to it.

Net OCC SW- Can write 4 values:

0 = Unoccupied

1 = Occupied

2 = Override: Puts unit into override amount of time in specified in the Setpoint. Only needs to write 2 for a few seconds to force override, then it writes to a 1.

3 = Schedule: Uses schedule input in MicroMag.

### 15.10. MicroMag BMS protocols settings

The BACNET DEVICE ID is a five-digit number. The first three digits are based on our BACnet vendor ID 181, and the last two are set by the BACnet/MSTP address.

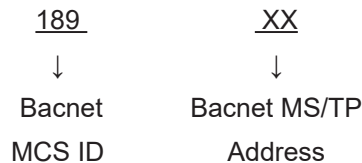

The BACnet address can be verified and changed (with the proper authorization code) from the Keypad/Display. The following steps will display the BACnet MSTP Network address, and the Baud Rate:

### 15.11. Modbus RTU

The Modbus RTU address can be verified and changed (with the proper authorization code) from the keypad/LCD. The following steps will display the Modbus RTU Network address, and the Baud Rate:

- Press the Menu key, select Serv Tools, and then press the Enter key.
- Select RS485 Network then press Enter.
- Select Protocol then press Enter. Change the protocol to Modbus.
- Select address then press Enter. Change the address then press Enter.
- Select Baud then press Enter. Set the baud rate then press Enter.

## Chapter - 16. MicroMag States

### 16.1. Economizer States

State	Description
OFF AND CLOSED	Economizer at min. because unoccupied, unit off or no air flow
AT MIN OPEN %	Economizer at minimum position and CO2 within range
AT HI CO2 OPEN %	Economizer at high CO2 position
ECON ON – NORMAL	Economizer on
ECON ON – HI CO2	Economizer is on but the CO2 is also high
OUTDR DMPR OPEN	Outside damper is open when occupied and at full position
OUTDR DMPR OFF	Outside damper closed in unoccupied mode
ECON ON–HOOD ON	Economizer on but Hood on is overriding damper position
EXHAUST HOOD ON	Economizer off, damper at maximum position because Hood is on

### 16.2. Evaporator Fan State

State	Description
EVAP INIT	The evaporator Fan Capacity Control is in initialization mode
UNLDING AZ	Evaporator Fan is unloading, capacity is above zone and heating
LOADING AZ	Evaporator Fan is loading, capacity is above zone and cooling
HOLDING AZ	Currently not used
UNLDING BZ	Evaporator Fan is unloading, capacity is below zone and cooling
LOADING BZ	Evaporator Fan is loading, capacity is below zone and heating
HOLDING BZ	Currently not used
UNLDING IZ	Evaporator Fan is unloading, capacity is in zone based on ROC
LOADING IZ	Evaporator Fan is loading, capacity is in zone based on ROC
HOLDING IZ	Evaporator Fan is holding capacity is in the zone and ROC stable
UNLD ROC	Evaporator Fan is unloading because of a high ROC
LOAD ROC	Evaporator Fan is loading because of a low ROC
HOLD ROC	Evaporator Fan is holding, capacity is approaching target at acceptable ROC
EVAP ON	Evaporator Fan is on
DISABLED	Evaporator Fan is disabled
LOCKED OUT	Evaporator Fan is Locked Out
POST DELAY	Evaporator Fan is shutting down and is in post delay time
PRE DELAY	Evaporator Fan is running in pre delay time
EVAP OFF	Evaporator Fan is off
EVAP SUPER	Evaporator Fan is running in supervisor mode

**16.3. Pump States**

State	Description
PUMP INIT	Pump I in unitization mode
PUMP ON	Pump is on
PUMP OFF	Pump is off
PUMP SUPER	Pump is in supervisor mode

**16.4. Cooling States**

State	Description
COOL INIT	Cooling is initialization mode
UNLOADING AZ	We are above the zone and unloading (ROC)
LOADING AZ	We are above the zone and loading (normal)
HOLDING AZ	We are above the zone and holding (ROC)
UNLOADING BZ	We are below the zone and unloading (normal)
LOADING BZ	We are below the zone and loading (ROC)
HOLDING BZ	We are below the zone and holding (ROC)
UNLOADING IZ	We are in the zone and unloading (ROC)
LOADING IZ	We are in the zone and loading (ROC)
HOLDING IZ	We are in the zone and holding (normal)
UNLD ROC	We are unloading based on ROC
LOAD ROC	We are loading based on ROC
HOLD ROC	We are holding based on ROC
OFF & READY	The cooling is off but ready to run
DISABLED	The cooling is disabled
NO FLOW	The cooling is off because there is no flow
N/A	The cooling is not available
LOCKED OUT	The cooling is locked out
SUPERISOR	We are in supervised mode
HOLD PCOOL	We are in pre cooling and holding

## 16.5. Condenser States

State	Description
COND INIT	The condenser is in initialization state
UNLOADING AZ	We are above the zone and unloading (ROC)
LOADING AZ	We are above the zone and loading (normal)
HOLDING AZ	We are above the zone and holding (ROC)
UNLOADING BZ	We are below the zone and unloading (normal)
LOADING BZ	We are below the zone and loading (ROC)
HOLDING BZ	We are below the zone and holding (ROC)
UNLOADING IZ	We are in the zone and unloading (ROC)
LOADING IZ	We are in the zone and loading (ROC)
HOLDING IZ	We are in the zone and holding (normal)
UNLD ROC	We are unloading based on ROC
LOAD ROC	We are loading based on ROC
HOLD ROC	We are holding based on ROC
DISABLED	The condenser is disabled
NO FLOW	The unit is off because there is no flow
LOCKED OUT	The condenser is locked out
COND OFF	The condenser is off
N/A	The condenser is not available

## 16.6. Heating States

State	Description
HEATING INIT	The stage of heating is in initialization state
UNLOADING AZ	We are above the zone and unloading (normal)
LOADING AZ	We are above the zone and loading (ROC)
HOLDING AZ	We are above the zone and holding (ROC)
UNLOADING BZ	We are below the zone and unloading (ROC)
LOADING BZ	We are below the zone and loading (normal)
HOLDING BZ	We are below the zone and holding (ROC)
UNLOADING IZ	We are in the zone and unloading (ROC)
LOADING IZ	We are in the zone and loading (ROC)
HOLDING IZ	We are in the zone and holding (normal)
UNLD ROC	We are unloading based on ROC
LOAD ROC	We are loading based on ROC
HOLD ROC	We are holding based on ROC
IGNITION	We are in ignition, looking for temperature rise [sp 100 within time(sec)]
WARMING UP	Ignition occurred go to warmup stage (sp 101)
OPERATING	We are in normal operations
HOLD IGNTN	We are holding for ignition
OFF&READY	We are off & ready to run
DISABLED	This stage of heating has been disabled
NO FLOW	We are off because there is no air flow

LOCKED OUT	We have had 2 failures within 2 hours and are in lockout
N/A	Not Available
SUPERVISOR	We are in supervisor mode
SAFETY TRIP	We have had a safety trip. We will put back into service after safety time
HI AMBIENT	We are off on high ambient

### 16.7. Reheat States

State	Description
REHEAT INI	The reheating is in initialization state
UNLOADING AZ	We are above the zone and unloading (normal)
LOADING AZ	We are above the zone and loading (ROC)
HOLDING AZ	We are above the zone and holding (ROC)
UNLOADING BZ	We are below the zone and unloading (ROC)
LOADING BZ	We are below the zone and loading (normal)
HOLDING BZ	We are below the zone and holding (ROC)
UNLOADING IZ	We are in the zone and unloading (ROC)
LOADING IZ	We are in the zone and loading (ROC)
HOLDING IZ	We are in the zone and holding (normal)
UNLD ROC	We are unloading based on ROC
LOAD ROC	We are loading based on ROC
HOLD ROC	We are holding based on ROC
OFF & READY	We are off & ready to run
DISABLED	Reheat has been disabled
NO FLOW	We are off because there is no air flow
LOCKED OUT	We have had 2 failures within 2 hours and are in lockout
N/A	Not Available

### 16.8. Exhaust States

State	Description
EXHST INI	The Exhaust is in initialization state
UNLOADING AZ	Currently not used
LOADING AZ	We are above the zone and loading (normal)
HOLDING AZ	Currently not used
UNLOADING BZ	We are below the zone and unloading (normal)
LOADING BZ	Currently not used
HOLDING BZ	Currently not used
UNLOADING IZ	Currently not used
LOADING IZ	Currently not used
HOLDING IZ	We are in the zone and holding (normal)
UNLD ROC	Currently not used
LOAD ROC	Currently not used
HOLD ROC	Currently not used
OFF & READY	We are off & ready to run
DISABLED	Exhaust has been disabled



NO FLOW	Currently not used
LOCKED OUT	We are in lockout mode
N/A	Not Available
HOOD ON	Exhaust is open because hood is on

### 16.9. RTU Algo States

State	Description
PowerUpDelay	This is a power up delay before starting to run the algorithm
MCS IO FAILED	We have failed to communicate to an RO6 or SI8AO4 board
MACH LOCKOUT	The Unit is in lockout mode
OFF SMOKE AL	The Unit is off on smoke alarm
OFF SCHEDULE	The Unit is off based on current schedule
OFF DEMAND	The Unit is off based on no current load
OFF RUN/STOP	The Unit is off based on RUN/STOP switch in STOP
DIRECT SUPERV	The Unit is under supervised mode
EVAP FAN ONLY	The unit is off and we are in evaporator fan only
COOLING	The Unit is in COOLING mode
HEATING	The Unit is in HEATING mode
DEHUMID	The Unit is in Dehumidification mode
HEAT: HP ONLY	The unit is in HEAT mode with heat pump only running
HEAT:HP + AUX	The Unit is in HEATING mode with the heat pump running + the AUX on
HEAT:AUX ONLY	The Unit is in HEATING mode with AUX only on
HEAT:AUX+EMRG	The Unit is in HEATING mode with AUX and EMRG n
HEAT:ALL	The Unit is in HEATING mode and all available stages are on
HEAT:EMERG	The Unit is in HEATING mode and the EMERG heat is on
HEAT:PRIMARY	The Unit is in HEATING mode, no heat pump, running primary heating
MORN WARM UP	The Unit is in HEATING mode for morning warm up
COOL:HI HUMID	The Unit is in COOLING mode based on high humidity

### 16.10. Chiller States

State	Description
PUMP ONLY	Replaces 'EVAP FAN ONLY' in RTU Algo States (#8)

## 16.11. Compressor States

State	Description
LOST IO	Lost communications to an IO board
SAFETY TRIP	This compressor has tripped on a safety. It will be put back in the ready state after the safety time
LOCKOUT	This compressor has been locked out. (From lost IO, multiple safety trips of same type within 2 hours, etc)
DISABLED	The compressor has been disabled. (Disable switch has been turned on)
OFF:LowAmb	The compressor is off based on low ambient
OFF: DEHUM	This stage is not available for dehumidification
PUMPDOWN	The compressor is in PUMP DOWN state, either at startup or shutdown
ANTI CYCLE	The compressor is off and in anti cycle mode. (Setpoint #40 & #41 provide off to on and on to on. On to on provides control for number of cycles per hour.)
OFF&READY	The compressor is off and ready to run. It must be in the off and ready to run for a minimum of 1 minute
REVERSING	This compressor is used as a heat pump and the reversing valve is on
START-UP	This compressor is in startup mode. Startup is a function of the compressor type.
RUNNING	This compressor is running
DEFROSTING	This compressor is in a defrost cycle
SucPsiHOLD	The compressor is in a suction psi hold
SucPsiUNLD	The compressor is in a suction unload condition
DisPsiUNLD	The compressor is in a discharge pressure unload
DisPsiHOLD	The compressor is in a discharge pressure hold
UNLD LOTMP	Not implanted
HOLD LOTMP	Not implanted
HOLD HIAMP	The compressor is holding based on high ampere draw
DIS TMPHLD	The compressor is holding based on high discharge temperature
HOLD HIWTR	Not implanted
UNLD HIAMP	The compressor is unloading due to current high amps
UNLD HITMP	Not implanted
HOLD HITMP	Not implanted
DIS TmUNLD	The compressor is unloading based on current high discharge temperature
DisSh UNLD	The compressor is unloading based on high discharge superheat
DisSH HOLD	Not implanted

## 18.1. BACnet Properties

Bacnet Property	AI	AV	AO	BO	MSV
PROP_OBJECT_IDENTIFIER	X	X	X	X	X
PROP_OBJECT_NAME	X	X	X	X	X
PROP_DESCRIPTION	X	X	X	X	X
PROP_OBJECT_TYPE	X	X	X	X	X
PROP_PRESENT_VALUE	X	X	X	X	X
PROP_STATUS_FLAGS	X	X	X	X	X
PROP_EVENT_STATE	X	X	X	X	X
PROP_OUT_OF_SERVICE	X	X	X	X	X
PROP_UNITS	X	X	X	X	
PROP_RELINQUISH_DEFAULT			X	X	
PROP_PRIORITY_ARRAY			X	X	
PROP_NUMBER_OF_STATES					X
PROP_STATE_TEXT					X

AI = Analog Inputs

AV = Analog Value

AO = Analog Outputs

BO = Binary or Relay Outputs

MSV = Multi State Values

## 18.2. MICROMAG PROTOCOLS

### 1. MCS PROTOCOL

### 2. MODBUS RTU PROTOCOL

### 3. BACnet MS/TP PROTOCOL

The RS-485 address can be verified and changed (with the proper authorization code) from the keypad/LCD.

The following steps will display the RS-485 Network address, and the Baud Rate:

- Press the Menu key, select Service Tools, and then press the Enter key.
- Select RS485 Network then press Enter.
- Select Protocol then press Enter. Change the protocol: **MCS PROTOCOL, MODBUS RTU, or BACnet.**
- Select address then press Enter. Change the address then press Enter.
- Select Baud then press Enter. Set the baud rate then press Enter.
- Connect the communication wires to the TX RS485 three position portion of the six position terminal block located above the display.

### 18.2.1 BACNET PROTOCOL DEVICE ID

The BACnet DEVICE ID is a five-digit number. The first three digits are based on our BACnet vendor ID 181, and the last two are set by the BACnet/MS/TP address.

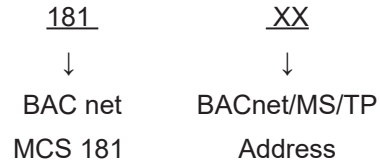

The BACnet address can be verified and changed (with the proper authorization code) from the Keypad/Display. The following steps will display the BACnet MS/TP Network address, and the Baud Rate:

- Press the Menu key, select Service Tools, and then press the Enter key.
- Select RS485 Network then press Enter.
- Select Protocol then press Enter. Change the protocol to BACnet protocol.
- Select BACnet ID then press Enter. Change the ID then press Enter.
- Select Baud then press Enter. Set the baud rate then press Enter.

### 18.2.2 Network inputs to MicroMag

The MicroMag can receive changes from the network to enable or disable the Network Run/Stop & Network Target Reset.

The MicroMag has a large number of Setpoints that can be written to or from the BMS. They are identified in the Setpoint BMS Points Writable chart found later in this section.

**Net Run/Stop** – Does not need a virtual SI or to be pointed to it.

Net OCC SW- Can write 4 values:

**0** = Unoccupied

**1** = Occupied

**2** = Override: Puts unit into override amount of time in specified in the Setpoint. Only needs to write 2 for a few seconds to force override, then it writes to a 1.

**3** = Schedule: Uses schedule input in MicroMag.

### 18.3. BMS Sensor Input Points

Sensor numbering is based upon the MicroMag or MCS-SI hardware type board, Notable BACnet properties available: MicroMag supports up to 42 sensor Inputs. Refer to points lists for BACnet Naming.

The **Assumed Decimal** column changes depending on the Display Type of the sensor.

MICROMAG	BACnet ID		MODBUS RTU	
	PT#	BACnet ID	Name	Register
Sensor M-1	AI:1	Refer to Config	30001	1
Sensor M-2	AI:2	Refer to Config	30002	1
Sensor M-3	AI:3	Refer to Config	30003	1
Sensor M-4	AI:4	Refer to Config	30004	1
Sensor M-5	AI:5	Refer to Config	30005	1
Sensor M-6	AI:6	Refer to Config	30006	1
Sensor M-7	AI:7	Refer to Config	30007	1
Sensor M-8	AI:8	Refer to Config	30008	1
Sensor M-9	AI:9	Refer to Config	30009	0
Sensor M-10	AI:10	Refer to Config	30010	0
Sensor 1-1	AI:11	Refer to Config	30011	0
Sensor 1-2	AI:12	Refer to Config	30012	0
Sensor 1-3	AI:13	Refer to Config	30013	0
Sensor 1-4	AI:14	Refer to Config	30014	0
Sensor 1-5	AI:15	Refer to Config	30015	0
Sensor 1-6	AI:16	Refer to Config	30016	0
Sensor 1-7	AI:17	Refer to Config	30017	0
Sensor 1-8	AI:18	Refer to Config	30018	0
Sensor 1-9	AI:19	Refer to Config	30019	0
Sensor 1-10	AI:20	Refer to Config	30020	0
Sensor 1-11	AI:21	Refer to Config	30021	0
Sensor 1-12	AI:22	Refer to Config	30022	0
Sensor 1-13	AI:23	Refer to Config	30023	0
Sensor 1-14	AI:24	Refer to Config	30024	0
Sensor 1-15	AI:25	Refer to Config	30025	0
Sensor 1-16	AI:26	Refer to Config	30026	0
Sensor 2-1	AI:27	Refer to Config	30011	0
Sensor 2-2	AI:28	Refer to Config	30012	0
Sensor 2-3	AI:29	Refer to Config	30013	0
Sensor 2-4	AI:30	Refer to Config	30014	0
Sensor 2-5	AI:31	Refer to Config	30015	0
Sensor 2-6	AI:32	Refer to Config	30016	0
Sensor 2-7	AI:33	Refer to Config	30017	0
Sensor 2-8	AI:34	Refer to Config	30018	0
Sensor 2-9	AI:35	Refer to Config	30019	0
Sensor 2-10	AI:36	Refer to Config	30020	0
Sensor 2-11	AI:37	Refer to Config	30021	0

MICROMAG	BACnet ID		MODBUS RTU	
PT#	BACnet ID	Name	Register	#Assumed Decimal
Sensor 2-12	AI:38	Refer to Config	30022	0
Sensor 2-13	AI:39	Refer to Config	30023	0
Sensor 2-14	AI:40	Refer to Config	30024	0
Sensor 2-15	AI:41	Refer to Config	30025	0
Sensor 2-16	AI:42	Refer to Config	30026	0

#### 18.4. BMS Relay Output Points

Sensor numbering is based upon the MicroMag or MCS-RO hardware type board Notable BACnet properties available. MicroMag supports up to 20 relay outputs. Refer to points lists for Bacnet Naming.

Assumed Decimal column for BO is always 0 but should match the print and grid shown in cfg and connect.

MICROMAG	BACnet ID		MODBUS RTU	
PT#	BACnet ID	Name	Register	#Assumed Decimal
Relay M-1	BO:1	Refer to Config	00001	0
Relay M-2	BO:2	Refer to Config	00002	0
Relay M-3	BO:3	Refer to Config	00003	0
Relay M-4	BO:4	Refer to Config	00004	0
Relay M-5	BO:5	Refer to Config	00005	0
Relay M-6	BO:6	Refer to Config	00006	0
Relay 1-1	BO:7	Refer to Config	00007	0
Relay 1-2	BO:8	Refer to Config	00008	0
Relay 1-3	BO:9	Refer to Config	00009	0
Relay 1-4	BO:10	Refer to Config	00010	0
Relay 1-5	BO:11	Refer to Config	00011	0
Relay 1-6	BO:12	Refer to Config	00012	0
Relay 1-7	BO:13	Refer to Config	00013	0
Relay 1-8	BO:14	Refer to Config	00014	0
Relay 1-9	BO:15	Refer to Config	00015	0
Relay 1-10	BO:16	Refer to Config	00016	0
Relay 2-1	BO:7	Refer to Config	00017	0
Relay 2-2	BO:8	Refer to Config	00018	0
Relay 2-3	BO:9	Refer to Config	00019	0
Relay 2-4	BO:10	Refer to Config	00020	0
Relay 2-5	BO:11	Refer to Config	00021	0
Relay 2-6	BO:12	Refer to Config	00022	0
Relay 2-7	BO:13	Refer to Config	00023	0
Relay 2-8	BO:14	Refer to Config	00024	0
Relay 2-9	BO:15	Refer to Config	00025	0
Relay 2-10	BO:16	Refer to Config	00026	0

## 18.5. BMS Analog Output Points

Sensor numbering is based upon the MicroMag or MCS-SI hardware type board Notable BACnet properties available. MicroMag supports up to 12 analog outputs. Refer to points lists for BACnet Naming.

Assumed Decimal for AO is always a 1 because an AO is a % from 0.0% to 100.0%

MICROMAG PT#	BACnet ID		MODBUS RTU	
	BACnet ID	Name	Register	#Assumed Decimal
M-T	AO:1	TRIAC SPARE	40001	1
Analog M-1	AO:2	Refer to Config	40002	1
Analog M-2	AO:3	Refer to Config	40003	1
Analog M-3	AO:4	Refer to Config	40004	1
Analog M-4	AO:5	Refer to Config	40005	1
Analog 1-1	AO:6	Refer to Config	40006	1
Analog 1-2	AO:7	Refer to Config	40007	1
Analog 1-3	AO:8	Refer to Config	40008	1
Analog 1-4	AO:9	Refer to Config	40009	1
Analog 2-1	AO:10	Refer to Config	40010	1
Analog 2-2	AO:11	Refer to Config	40011	1
Analog 2-3	AO:12	Refer to Config	40012	1
Analog 2-4	AO:13	Refer to Config	40013	1

## 18.6. BACnet MS/TP BMS Setpoints

MicroMag supports up to 200 setpoints. Refer to points lists for BACnet Naming.

The Assumed Decimals Column changes depending on the Display Type selected.

MCS-MICROMAG		BACnet MS/TP		MODBUS RTU	
PT#	Name	Object ID	Name	Register	#Assumed Decimal
1	COOL ENABLE	AV:1	STP#1-COOL ENABLE	41001	1
2	HEAT ENABLE	AV:2	STP#2-HEAT ENABLE	41002	1
3	DEH ENABLE	AV:3	STP#3-DEH ENABLE	41003	1
4	DehCmpMinOvr	AV:4	STP#4-DehCmpMinOvr	41004	1
5	CoolNiteStbk	AV:5	STP#5-CoolNiteStbk	41005	1
6	HeatNiteStbk	AV:6	STP#6-HeatNiteStbk	41006	1
7	Deh NiteStbk	AV:7	STP#7-Deh NiteStbk	41007	1
8	COOL TARGET	AV:8	STP#8-COOL TARGET	41008	1
9	CoolStepDely	AV:9	STP#9-CoolStepDely	41009	0
10	HEAT TARGET	AV:10	STP#10-HEAT TARGET	41010	1
11	HeatStepDely	AV:11	STP#11-HeatStepDely	41011	0
12	REHT TARGET	AV:12	STP#12-REHT TARGET	41012	1
13	RehtStepDely	AV:13	STP#13-RehtStepDely	41013	0
14	S-FanSpd %	AV:14	STP#14-S-FanSpd %	41014	2
15	S-FanSpd Dly	AV:15	STP#15-S-FanSpd Dly	41015	0
16	CL/HT PreDly	AV:16	STP#16-CL/HT PreDly	41016	0
17	CND TRGT PSI	AV:17	STP#17-CND TRGT PSI	41017	1
18	CND STEP DLY	AV:18	STP#18-CND STEP DLY	41018	0
19	EconAmbEnabl	AV:19	STP#19-EconAmbEnabl	41019	1
20	ECON MAX %	AV:20	STP#20-ECON MAX %	41020	1
21	HiCO2MinDmpr	AV:21	STP#21-HiCO2MinDmpr	41021	1
22	MIN DAMPER %	AV:22	STP#22-MIN DAMPER %	41022	1
23	DehSucTmpTrg	AV:23	STP#23-DehSucTmpTrg	41023	1
24	DIRTY FILTER	AV:24	STP#24-DIRTY FILTER	41024	1
25	EcoToMechDly	AV:25	STP#25-EcoToMechDly	41025	0
26	BldgStatcTrg	AV:26	STP#26-BldgStatcTrg	41026	2
27	BldgStatcDly	AV:27	STP#27-BldgStatcDly	41027	0
28	ExhFanMinRun	AV:28	STP#28-ExhFanMinRun	41028	0
29	SFanMin%Cool	AV:29	STP#29-SFanMin%Cool	41029	2
30	SFanMin%Heat	AV:30	STP#30-SFanMin%Heat	41030	2
31	HiBldgStatic	AV:31	STP#31-HiBldgStatic	41031	2
32	HI CO2 LEVEL	AV:32	STP#32-HI CO2 LEVEL	41032	0
33	HI CO2 ZONE	AV:33	STP#33-HI CO2 ZONE	41033	0
34	LoAmbCompOff	AV:34	STP#34-LoAmbCompOff	41034	1
35	HiAmbHeatOff	AV:35	STP#35-HiAmbHeatOff	41035	1
36	OVERRIDE	AV:36	STP#36-OVERRIDE	41036	0
37	LEAD COMPRES	AV:37	STP#37-LEAD COMPRES	41037	0
38	CompRotation	AV:38	STP#38-CompRotation	41038	0
39	COMP MIN RUN	AV:39	STP#39-COMP MIN RUN	41039	0
40	ACYC ON-ON	AV:40	STP#40-ACYC ON-ON	41040	0
41	ACYC OFF-ON	AV:41	STP#41-ACYC OFF-ON	41041	0
42	PMP DOWN PSI	AV:42	STP#42-PMP DOWN PSI	41042	1



MCS-MICROMAG		BACnet MS/TP		MODBUS RTU	
PT#	Name	Object ID	Name	Register	#Assumed Decimal
43	PmpDownDelay	AV:43	STP#43-PmpDownDelay	41043	0
44	SERVICE MODE	AV:44	STP#44-SERVICE MODE	41044	0
45	SftyUnldDely	AV:45	STP#45-SftyUnldDely	41045	0
46	SftyHoldDely	AV:46	STP#46-SftyHoldDely	41046	0
47	SftyUnldAdj	AV:47	STP#47-SftyUnldAdj	41047	1
48	CompStartup%	AV:48	STP#48-CompStartup%	41048	1
49	SPARE STPT	AV:49	STP#49-SPARE STPT	41049	0
50	CmpAdjustDly	AV:50	STP#50-CmpAdjustDly	41050	0
51	COMPR 1 FLA	AV:51	STP#51-COMPR 1 FLA	41051	1
52	COMPR 2 FLA	AV:52	STP#52-COMPR 2 FLA	41052	1
53	COMPR 3 FLA	AV:53	STP#53-COMPR 3 FLA	41053	1
54	COMPR 4 FLA	AV:54	STP#54-COMPR 4 FLA	41054	1
55	LOW AMP %	AV:55	STP#55-LOW AMP %	41055	1
56	HIGH AMP %	AV:56	STP#56-HIGH AMP %	41056	1
57	HiAmpUnldHld	AV:57	STP#57-HiAmpUnldHld	41057	1
58	NoCompProof	AV:58	STP#58-NoCompProof	41058	0
59	HI MOTOR TMP	AV:59	STP#59-HI MOTOR TMP	41059	1
60	COMP FAULT	AV:60	STP#60-COMP FAULT	41060	0
61	COND FAULT	AV:61	STP#61-COND FAULT	41061	0
62	LOW SUCT PSI	AV:62	STP#62-LOW SUCT PSI	41062	1
63	HP SUCT OFST	AV:63	STP#63-HP SUCT OFST	41063	1
64	UNSAFE SUCT	AV:64	STP#64-UNSAFE SUCT	41064	1
65	LO SUCT UNLD	AV:65	STP#65-LO SUCT UNLD	41065	1
66	LO SUCT RELD	AV:66	STP#66-LO SUCT RELD	41066	1
67	LO SUCT SPHT	AV:67	STP#67-LO SUCT SPHT	41067	1
68	HI SUCT SPHT	AV:68	STP#68-HI SUCT SPHT	41068	1
69	LOW DISC PSI	AV:69	STP#69-LOW DISC PSI	41069	1
70	HI DISC PSI	AV:70	STP#70-HI DISC PSI	41070	1
71	HI DISC UNLD	AV:71	STP#71-HI DISC UNLD	41071	1
72	HI DISC RELD	AV:72	STP#72-HI DISC RELD	41072	1
73	HI DISC TEMP	AV:73	STP#73-HI DISC TEMP	41073	1
74	DiscTmpUnld	AV:74	STP#74-DiscTmpUnld	41074	1
75	DiscTmpReld	AV:75	STP#75-DiscTmpReld	41075	1
76	LO DISC SPHT	AV:76	STP#76-LO DISC SPHT	41076	1
77	DisSprhtUnld	AV:77	STP#77-DisSprhtUnld	41077	1
78	DisSprhtReld	AV:78	STP#78-DisSprhtReld	41078	1
79	LOW DIFF PSI	AV:79	STP#79-LOW DIFF PSI	41079	1
80	UnsafeDiffPSI	AV:80	STP#80-UnsafeDifPSI	41080	1
81	HI PSI SW	AV:81	STP#81-HI PSI SW	41081	0
82	LO PSI SW	AV:82	STP#82-LO PSI SW	41082	0
83	PhasLossRset	AV:83	STP#83-PhasLossRset	41083	0
84	HEAT FAULT	AV:84	STP#84-HEAT FAULT	41084	0
85	HiSupplyTmp	AV:85	STP#85-HiSupplyTmp	41085	1
86	FREEZE TEMP	AV:86	STP#86-FREEZE TEMP	41086	1
87	COMPR 5 FLA	AV:87	STP#87-COMPR 5 FLA	41087	1

MCS-MICROMAG		BACnet MS/TP		MODBUS RTU	
PT#	Name	Object ID	Name	Register	#Assumed Decimal
88	COMPR 6 FLA	AV:88	STP#88-COMPR 6 FLA	41088	0
89	CFG TEST = 0	AV:89	STP#89-CFG TEST = 0	41089	1
90	HPLowAmbDsbl	AV:90	STP#90-HPLowAmbDsbl	41090	0
91	RevValveDely	AV:91	STP#91-RevValveDely	41091	1
92	HPAmbDsblDef	AV:92	STP#92-HPAmbDsblDef	41092	1
93	DEF TERM TMP	AV:93	STP#93-DEF TERM TMP	41093	0
94	MaxDefRunTim	AV:94	STP#94-MaxDefRunTim	41094	1
95	WtdDefDur %	AV:95	STP#95-WtdDefDur %	41095	0
96	BtweenDefAdj	AV:96	STP#96-BtweenDefAdj	41096	0
97	DelayBtwnDef	AV:97	STP#97-DelayBtwnDef	41097	1
98	HPCndTrgOfst	AV:98	STP#98-HPCndTrgOfst	41098	1
99	MaxTrgtReset	AV:99	STP#99-MaxTrgtReset	41099	1
100	IGN PROOF	AV:100	STP#100-IGN PROOF	41100	0
101	ModGasWarmup	AV:101	STP#101-ModGasWarmup	41101	1
102	AuxHtMin/Max	AV:102	STP#102-AuxHtMin/Max	41102	1
103	WARMUP TEMP	AV:103	STP#103-WARMUP TEMP	41103	0
104	WARMUP TIME	AV:104	STP#104-WARMUP TIME	41104	2
105	SPARE STPT	AV:105	STP#105-SPARE STPT	41105	2
106	SPARE STPT	AV:106	STP#106-SPARE STPT	41106	1
107	GasLoFireDsb	AV:107	STP#107-GasLoFireDsb	41107	0
108	SMOKE ALARM	AV:108	STP#108-SMOKE ALARM	41108	1
109	COOL RESET +	AV:109	STP#109-COOL RESET +	41109	1
110	USER RESET	AV:110	STP#110-USER RESET	41110	0
111	COOL RESET -	AV:111	STP#111-COOL RESET -	41111	0
112	HEAT RESET +	AV:112	STP#112-HEAT RESET +	41112	0
113	HEAT RESET -	AV:113	STP#113-HEAT RESET -	41113	0
114	PRECOOL TARG	AV:114	STP#114-PRECOOL TARG	41114	0
115	PRECOOL ADJ	AV:115	STP#115-PRECOOL ADJ	41115	0
116	SplyCfmTrgt	AV:116	STP#116-SplyCfmTrgt	41116	0
117	CFM STP DELY	AV:117	STP#117-CFM STP DELY	41117	0
118	MaxStaticRst	AV:118	STP#118-MaxStaticRst	41118	0
119	HOOD DEH ENB	AV:119	STP#119-HOOD DEH ENB	41119	0
120	NO FLOW	AV:120	STP#120-NO FLOW	41120	0
121	Cool UnldOff	AV:121	STP#121-Cool UnldOff	41121	0
122	Heat UnldOff	AV:122	STP#122-Heat UnldOff	41122	0
123	DEH UnldOff	AV:123	STP#123-DEH UnldOff	41123	0
124	FREEZE UNLD	AV:124	STP#124-FREEZE UNLD	41124	0
125	FREEZE RELD	AV:125	STP#125-FREEZE RELD	41125	0
126	CondStart %	AV:126	STP#126-CondStart %	41126	0
127	HI DUCT PSI	AV:127	STP#127-HI DUCT PSI	41127	0
128	WtrVlvFreeze	AV:128	STP#128-WtrVlvFreeze	41128	0
129	ERW MIN DIFF	AV:129	STP#129-ERW MIN DIFF	41129	0
130	G-RATOR STBK	AV:130	STP#130-G-RATOR STBK	41130	0
131	MODGAS STAGE %	AV:131	STP#131-MODGAS STAGE %	41131	0
132	EXV TARGET	AV:132	STP#132-EXV TARGET	41132	0

MCS-MICROMAG		BACnet MS/TP		MODBUS RTU	
PT#	Name	Object ID	Name	Register	#Assumed Decimal
133	EXV ADJUST	AV:133	STP#133-EXV ADJUST	41133	0
134	EXV LO SPRHT	AV:134	STP#134-EXV LO SPRHT	41134	0
135	EXV MOP TARG	AV:135	STP#135-EXV MOP TARG	41135	0
136	FIRE ALARM	AV:136	STP#136-FIRE ALARM	41136	0
137	CONDSATN ALM	AV:137	STP#137-CONDSATN ALM	41137	0
138	DAMPER FAULT	AV:138	STP#138-DAMPER FAULT	41138	0
139	OAD ON POS	AV:139	STP#139-OAD ON POS	41139	0
140	PREHEAT TARG	AV:140	STP#140-PREHEAT TARG	41140	0
141	PREHEAT ADJ	AV:141	STP#141-PREHEAT ADJ	41141	0
142	ERW ALARM	AV:142	STP#142-ERW ALARM	41142	0
143	SPARE STPT	AV:143	STP#143-SPARE STPT	41143	0
144	SPARE STPT	AV:144	STP#144-SPARE STPT	41144	0
145	SPARE STPT	AV:145	STP#145-SPARE STPT	41145	0
146	EXV LOAD ADJ	AV:146	STP#146-EXV LOAD ADJ	41146	0
147	DisPsiHtTape	AV:147	STP#147-DisPsiHtTape	41147	0
148	OIL LEVEL	AV:148	STP#148-OIL LEVEL	41148	0
149	SPARE STPT	AV:149	STP#149-SPARE STPT	41149	0
150	SPARE STPT	AV:150	STP#150-SPARE STPT	41150	0
151	SPARE STPT	AV:151	STP#151-SPARE STPT	41151	0
152	SPARE STPT	AV:152	STP#152-SPARE STPT	41152	0
153	SPARE STPT	AV:153	STP#153-SPARE STPT	41153	0
154	SPARE STPT	AV:154	STP#154-SPARE STPT	41154	0
155	SPARE STPT	AV:155	STP#155-SPARE STPT	41155	0
156	SPARE STPT	AV:156	STP#156-SPARE STPT	41156	0
157	SPARE STPT	AV:157	STP#157-SPARE STPT	41157	0
158	SPARE STPT	AV:158	STP#158-SPARE STPT	41158	0
159	SPARE STPT	AV:159	STP#159-SPARE STPT	41159	0
160	SPARE STPT	AV:160	STP#160-SPARE STPT	41160	0
161	SPARE STPT	AV:161	STP#161-SPARE STPT	41161	0
162	SPARE STPT	AV:162	STP#162-SPARE STPT	41162	0
163	SPARE STPT	AV:163	STP#163-SPARE STPT	41163	0
164	SPARE STPT	AV:164	STP#164-SPARE STPT	41164	0
165	SPARE STPT	AV:165	STP#165-SPARE STPT	41165	0
166	SPARE STPT	AV:166	STP#166-SPARE STPT	41166	0
167	SPARE STPT	AV:167	STP#167-SPARE STPT	41167	0
168	SPARE STPT	AV:168	STP#168-SPARE STPT	41168	0
169	SPARE STPT	AV:169	STP#169-SPARE STPT	41169	0
170	SPARE STPT	AV:170	STP#170-SPARE STPT	41170	0
171	SPARE STPT	AV:171	STP#171-SPARE STPT	41171	0
172	SPARE STPT	AV:172	STP#172-SPARE STPT	41172	0
173	SPARE STPT	AV:173	STP#173-SPARE STPT	41173	0
174	SPARE STPT	AV:174	STP#174-SPARE STPT	41174	0
175	SPARE STPT	AV:175	STP#175-SPARE STPT	41175	0
176	SPARE STPT	AV:176	STP#176-SPARE STPT	41176	0
177	SPARE STPT	AV:177	STP#177-SPARE STPT	41177	0

MCS-MICROMAG		BACnet MS/TP		MODBUS RTU	
PT#	Name	Object ID	Name	Register	#Assumed Decimal
178	SPARE STPT	AV:178	STP#178-SPARE STPT	41178	0
179	SPARE STPT	AV:179	STP#179-SPARE STPT	41179	0
180	SPARE STPT	AV:180	STP#180-SPARE STPT	41180	0
181	SPARE STPT	AV:181	STP#181-SPARE STPT	41181	0
182	SPARE STPT	AV:182	STP#182-SPARE STPT	41182	0
183	SPARE STPT	AV:183	STP#183-SPARE STPT	41183	0
184	SPARE STPT	AV:184	STP#184-SPARE STPT	41184	0
185	SPARE STPT	AV:185	STP#185-SPARE STPT	41185	0
186	SPARE STPT	AV:186	STP#186-SPARE STPT	41186	0
187	SPARE STPT	AV:187	STP#187-SPARE STPT	41187	0
188	SPARE STPT	AV:188	STP#188-SPARE STPT	41188	0
189	SPARE STPT	AV:189	STP#189-SPARE STPT	41189	0
190	SPARE STPT	AV:190	STP#190-SPARE STPT	41190	0
191	SPARE STPT	AV:191	STP#191-SPARE STPT	41191	0
192	SPARE STPT	AV:192	STP#192-SPARE STPT	41192	0
193	SPARE STPT	AV:193	STP#193-SPARE STPT	41193	0
194	SPARE STPT	AV:194	STP#194-SPARE STPT	41194	0
195	SPARE STPT	AV:195	STP#195-SPARE STPT	41195	0
196	SPARE STPT	AV:196	STP#196-SPARE STPT	41196	0
197	SPARE STPT	AV:197	STP#197-SPARE STPT	41197	0
198	SPARE STPT	AV:198	STP#198-SPARE STPT	41198	0
199	SPARE STPT	AV:199	STP#199-SPARE STPT	41199	0
200	SPARE STPT	AV:200	STP#200-SPARE STPT	41200	0

## 18.7. BACnet MS/TP Unit Control Information

The #Assumed Decimal column changes depending on the display type of the sensor.

MICROMAG		BACnet ID		MODBUS RTU	
PT#	Name	BACnet ID	Name	Register	#Assumed Decimal
1	Unit State	MV:0	UNIT STATE	46000	0
2	Occupation Mode	MV:1	OCCUPATION MODE	46001	0
3	Network Run Stop	MV:2	NETWORK RUN STOP	46002	0
4	Cool State	MV:15	COOL STATE	46015	0
5	ALARM 1 NAME	MV:110	ALARM 1 NAME	46110	0
6	ALARM 2 NAME	MV:111	ALARM 2 NAME	46111	0
7	ALARM 3 NAME	MV:112	ALARM 3 NAME	46112	0
8	ALARM 4 NAME	MV:113	ALARM 4 NAME	46113	0
9	ALARM 5 NAME	MV:114	ALARM 5 NAME	46114	0
10	ALARM 1 DETAILS	MV:115	ALARM 1 DETAILS	46115	0
11	ALARM 2 DETAILS	MV:116	ALARM 2 DETAILS	46116	0
12	ALARM 3 DETAILS	MV:117	ALARM 3 DETAILS	46117	0
13	ALARM 4 DETAILS	MV:118	ALARM 4 DETAILS	46118	0
14	ALARM 5 DETAILS	MV:119	ALARM 5 DETAILS	46119	0
15	EXV 1 State	MV:130	EXV 1 STATE	46130	0
16	EXV 2 State	MV:135	EXV 2 STATE	46135	0

MICROMAG		BACnet ID		MODBUS RTU	
17	EXV 3 State	MV:140	EXV 3 STATE	46140	0
18	EXV 4 State	MV:145	EXV 4 STATE	46145	0
19	EXV 5 State	MV:146	EXV 5 STATE	46146	0
20	EXV 6 State	MV:147	EXV 6 STATE	46147	0
21	Unit State Time	AV:2001	UNIT STATE TIME	42001	0
22	Unit Cool Enable	AV:2002	UNIT COOL ENABLE	42002	1
23	Cool Target Reset	AV:2003	COOL TARGET RESET	42003	1
24	Cool State Time	AV:2100	COOL STATE TIME	42100	0
25	Cool Stages Wanted	AV:2101	COOL STAGES WANTED	42101	0
26	Cool Stages Active	AV:2102	COOL STAGES ACTIVE	42102	0
27	Cool Target	AV:2103	COOL TARGET	42103	0
28	Cool Control SI	AV:2104	COOL CONTROL SI	42104	1
29	Cool Wanted Capacity	AV:2105	COOL WANTED CAPACITY	42105	1
30	Cool Adjust Delay	AV:2106	COOL ADJUST DELAY	42106	0
31	Cool ROC	AV:2107	COOL ROC	42107	1

### 18.8. BACnet Compressor States

MICROMAG		BACnet ID		MODBUS RTU	
PT#	Name	BACnet ID	Name	Register	#Assumed Decimal
1	COMP #1 State	MV:20	COMP #1 STATE	46020	0
2	COMP #2 State	MV:25	COMP #2 STATE	46025	0
3	COMP #3 State	MV:30	COMP #3 STATE	46030	0
4	COMP #4 State	MV:35	COMP #4 STATE	46035	0
5	COMP #5 State	MV:160	COMP #5 STATE	46160	0
6	COMP #6 State	MV:165	COMP #6 STATE	46165	0
7	COND #1 State	MV:40	COND #1 STATE	46040	0
8	COND #3 State	MV:45	COND #3 STATE	46045	0
9	COND #4 State	MV:50	COND #4 STATE	46050	0
10	COND #5 State	MV:170	COND #5 STATE	46170	0
11	COND #6 State	MV:171	COND #6 STATE	46171	0
12	Cond 1 State Time	AV:2150	COND 1 STATE TIME	42150	0
13	Cond 1 Stages Wanted	AV:2151	COND 1 STAGES WANTED	42151	0
14	Cond 1 Stages Active	AV:2152	COND 1 STAGES ACTIVE	42152	0
15	Cond 1 Target	AV:2153	COND 1 TARGET	42153	0
16	Cond 1 Control SI	AV:2154	COND 1 CONTROL SI	42154	1
17	Cond 1 Wanted Capacity	AV:2155	COND 1 WANTED CAPACITY	42155	1
18	Cond 1 Adjust Delay	AV:2156	COND 1 ADJUST DELAY	42156	0
19	Cond 1 ROC	AV:2157	COND 1 ROC	42157	1
20	Cond 3 State Time	AV:2250	COND 3 STATE TIME	42250	0
21	Cond 3 Stages Wanted	AV:2251	COND 3 STAGES WANTED	42251	0
22	Cond 3 Stages Active	AV:2252	COND 3 STAGES ACTIVE	42252	0
23	Cond 3 Target	AV:2253	COND 3 TARGET	42253	0
24	Cond 3 Control SI	AV:2254	COND 3 CONTROL SI	42254	1
25	Cond 3 Wanted Capacity	AV:2255	COND 3 WANTED CAPACITY	42255	1
26	Cond 3 Adjust Delay	AV:2256	COND 3 ADJUST DELAY	42256	0
27	Cond 3 ROC	AV:2257	COND 3 ROC	42257	1

MICROMAG		BACnet ID		MODBUS RTU	
28	Cond 4 State Time	AV:2300	COND 4 STATE TIME	42300	0
29	Cond 4 Stages Wanted	AV:2301	COND 4 STAGES WANTED	42301	0
30	Cond 4 Stages Active	AV:2302	COND 4 STAGES ACTIVE	42302	0
31	Cond 4 Target	AV:2303	COND 4 TARGET	42303	0
32	Cond 4 Control SI	AV:2304	COND 4 CONTROL SI	42304	1
33	Cond 4 Wanted Capacity	AV:2305	COND 4 WANTED CAPACITY	42305	1
34	Cond 4 Adjust Delay	AV:2306	COND 4 ADJUST DELAY	42306	0
35	Cond 4 ROC	AV:2307	COND 4 ROC	42307	1
36	Cond 5 State Time	AV:2320	COND 5 STATE TIME	42320	0
37	Cond 5 Stages Wanted	AV:2321	COND 5 STAGES WANTED	42321	0
38	Cond 5 Stages Active	AV:2322	COND 5 STAGES ACTIVE	42322	0
39	Cond 5 Target	AV:2323	COND 5 TARGET	42323	0
40	Cond 5 Control SI	AV:2324	COND 5 CONTROL SI	42324	1
41	Cond 5 Wanted Capacity	AV:2325	COND 5 WANTED CAPACITY	42325	1
42	Cond 5 Adjust Delay	AV:2326	COND 5 ADJUST DELAY	42326	0
43	Cond 5 ROC	AV:2327	COND 5 ROC	42327	1
44	Cond 6 State Time	AV:2330	COND 6 STATE TIME	42330	0
45	Cond 6 Stages Wanted	AV:2331	COND 6 STAGES WANTED	42331	0
46	Cond 6 Stages Active	AV:2332	COND 6 STAGES ACTIVE	42332	0
47	Cond 6 Target	AV:2333	COND 6 TARGET	42333	0
48	Cond 6 Control SI	AV:2334	COND 6 CONTROL SI	42334	1
49	Cond 6 Wanted Capacity	AV:2335	COND 6 WANTED CAPACITY	42335	1
50	Cond 6 Adjust Delay	AV:2336	COND 6 ADJUST DELAY	42336	0
51	Cond 6 ROC	AV:2337	COND 6 ROC	42337	1
52	Comp 1 State Time	AV:2450	COMP 1 STATE TIME	42450	0
53	Comp 1 Sat Suction	AV:2452	COMP 1 SAT SUCTION	42452	1
54	Comp 1 Sat Dis Temp	AV:2454	COMP 1 SAT DIS TEMP	42454	1
55	Comp 1 Dis SH	AV:2455	COMP 1 DIS SH	42455	1
56	Comp 1 Oil Diff	AV:2456	COMP 1 OIL DIFF	42456	1
57	Comp 1 Lead Comp	AV:2457	COMP 1 LEAD COMP	42457	0
58	Comp 2 State Time	AV:2500	COMP 2 STATE TIME	42500	0
59	Comp 2 Sat Suction	AV:2502	COMP 2 SAT SUCTION	42502	1
60	Comp 2 Sat Dis Temp	AV:2504	COMP 2 SAT DIS TEMP	42504	1
61	Comp 2 Oil Diff	AV:2506	COMP 2 OIL DIFF	42506	1
62	Comp 2 Lead Comp	AV:2507	COMP 2 LEAD COMP	42507	0
63	Comp 3 State Time	AV:2550	COMP 3 STATE TIME	42550	0
64	Comp 3 Lead Comp	AV:2557	COMP 3 LEAD COMP	42557	0
65	Comp 4 State Time	AV:2600	COMP 4 STATE TIME	42600	0
66	Comp 4 Lead Comp	AV:2607	COMP 4 LEAD COMP	42607	0
67	Comp 5 State Time	AV:2610	COMP 5 STATE TIME	42610	0
68	Comp 5 Lead Comp	AV:2617	COMP 5 LEAD COMP	42617	0
69	Comp 6 State Time	AV:2620	COMP 6 STATE TIME	42620	0
70	Comp 6 Lead Comp	AV:2627	COMP 6 LEAD COMP	42627	0

**18.9. BMS Writable Network Points Information**

POINT MAPPING INFO BUILT IN MCS-MICROMAG

MICROMAG		BACnet ID		MODBUS RTU	
PT#	Name	BACnet ID	Name	Register	#Assumed Decimal
1	Net_R/S	AV:2008	Net_R/S	42008	0
2	Net_Occ_Mode	AV:2009	Net_Occ_Mode	42009	0

**18.10. BMS Points Writable Setpoint Points Grid Information**

POINT MAPPING INFO BUILT IN MCS-MICROMAG

MICROMAG		BACnet ID		MODBUS RTU	
PT#	Name	Object ID	Name	Register	#Assumed Decimal
1	COOL ENABLE	AV:1	COOL ENABLE	41001	1
2	HEAT ENABLE	AV:2	HEAT ENABLE	41002	1
3	DEH ENABLE	AV:3	DEH ENABLE	41003	1
4	DehCmpMinOvr	AV:4	DehCmpMinOvr	41004	1
5	CoolNiteStbk	AV:5	CoolNiteStbk	41005	1
6	HeatNiteStbk	AV:6	HeatNiteStbk	41006	1
7	Deh NiteStbk	AV:7	Deh NiteStbk	41007	1
8	COOL TARGET	AV:8	COOL TARGET	41008	1
10	HEAT TARGET	AV:10	HEAT TARGET	41010	1
12	REHT TARGET	AV:12	REHT TARGET	41012	1
14	SplyStatcTrg	AV:14	SplyStatcTrg	41014	2
17	CND TRGT PSI	AV:17	CND TRGT PSI	41017	1
19	EconAmbEnabl	AV:19	EconAmbEnabl	41019	1
21	HiCO2MinDmpr	AV:21	HiCO2MinDmpr	41021	1
22	MIN DAMPER %	AV:22	MIN DAMPER %	41022	1
26	BldgStatcTrg	AV:26	BldgStatcTrg	41026	2
32	HI CO2 LEVEL	AV:32	HI CO2 LEVEL	41032	0
114	PRECOOL TARG	AV:114	PRECOOL TARG	41114	0

**18.11. BMS SI Information**

POINT MAPPING INFO THROUGH OPTIONAL MCS-BMS-GATEWAY

MicroMag	BACnet IP		LONTALK	
PT#	ID	NAME	ID	NAME
Sensor M-1	AI:1	Refer to Config	AI:1	Refer to Config
Sensor M-2	AI:2	Refer to Config	AI:2	Refer to Config
Sensor M-3	AI:3	Refer to Config	AI:3	Refer to Config
Sensor M-4	AI:4	Refer to Config	AI:4	Refer to Config
Sensor M-5	AI:5	Refer to Config	AI:5	Refer to Config
Sensor M-6	AI:6	Refer to Config	AI:6	Refer to Config
Sensor M-7	AI:7	Refer to Config	AI:7	Refer to Config
Sensor M-8	AI:8	Refer to Config	AI:8	Refer to Config
Sensor M-9	AI:9	Refer to Config	AI:9	Refer to Config
Sensor M-10	AI:10	Refer to Config	AI:10	Refer to Config
Sensor 1-1	AI:11	Refer to Config	AI:11	Refer to Config
Sensor 1-2	AI:12	Refer to Config	AI:12	Refer to Config

MicroMag	BACnet IP		LONTALK	
Sensor 1-3	AI:13	Refer to Config	AI:13	Refer to Config
Sensor 1-4	AI:14	Refer to Config	AI:14	Refer to Config
Sensor 1-5	AI:15	Refer to Config	AI:15	Refer to Config
Sensor 1-6	AI:16	Refer to Config	AI:16	Refer to Config
Sensor 1-7	AI:17	Refer to Config	AI:17	Refer to Config
Sensor 1-8	AI:18	Refer to Config	AI:18	Refer to Config
Sensor 1-9	AI:19	Refer to Config	AI:19	Refer to Config
Sensor 1-10	AI:20	Refer to Config	AI:20	Refer to Config
Sensor 1-11	AI:21	Refer to Config	AI:21	Refer to Config
Sensor 1-12	AI:22	Refer to Config	AI:22	Refer to Config
Sensor 1-13	AI:23	Refer to Config	AI:23	Refer to Config
Sensor 1-14	AI:24	Refer to Config	AI:24	Refer to Config
Sensor 1-15	AI:25	Refer to Config	AI:25	Refer to Config
Sensor 1-16	AI:26	Refer to Config	AI:26	Refer to Config
Sensor 2-1	AI:27	Refer to Config	AI:27	Refer to Config
Sensor 2-2	AI:28	Refer to Config	AI:28	Refer to Config
Sensor 2-3	AI:29	Refer to Config	AI:29	Refer to Config
Sensor 2-4	AI:30	Refer to Config	AI:30	Refer to Config
Sensor 2-5	AI:31	Refer to Config	AI:31	Refer to Config
Sensor 2-6	AI:32	Refer to Config	AI:32	Refer to Config
Sensor 2-7	AI:33	Refer to Config	AI:33	Refer to Config
Sensor 2-8	AI:34	Refer to Config	AI:34	Refer to Config
Sensor 2-9	AI:35	Refer to Config	AI:35	Refer to Config
Sensor 2-10	AI:36	Refer to Config	AI:36	Refer to Config
Sensor 2-11	AI:37	Refer to Config	AI:37	Refer to Config
Sensor 2-12	AI:38	Refer to Config	AI:38	Refer to Config
Sensor 2-13	AI:39	Refer to Config	AI:39	Refer to Config
Sensor 2-14	AI:40	Refer to Config	AI:40	Refer to Config
Sensor 2-15	AI:41	Refer to Config	AI:41	Refer to Config
Sensor 2-16	AI:42	Refer to Config	AI:42	Refer to Config

**18.12. BMS RO Information - MCS-BMS-GATEWAY**

**POINT MAPPING INFO THROUGH OPTIONAL MCS-BMS-GATEWAY**

MicroMag	BACnet IP		LONTALK	
PT#	ID	NAME	ID	NAME
Relay M-1	DO:1	M_1_Refer to Config	DO:1	M_1_Refer to Configro
Relay M-2	DO:2	M_2_Refer to Config	DO:2	M_2_Refer to Configro
Relay M-3	DO:3	M_3_Refer to Config	DO:3	M_3_Refer to Configro



Relay M-4	DO:4	M_4_Refer to Config	DO:4	M_4_Refer to Configro
Relay M-5	DO:5	M_5_Refer to Config	DO:5	M_5_Refer to Configro
Relay M-6	DO:6	M_6_Refer to Config	DO:6	M_6_Refer to Configro
Relay 1-1	DO:7	1-1 Refer to Config	DO:7	1-1 Refer to Configro
Relay 1-2	DO:8	1-2 Refer to Config	DO:8	1-2 Refer to Configro
Relay 1-3	DO:9	1-3 Refer to Config	DO:9	1-3 Refer to Configro
Relay 1-4	DO:10	1-4 Refer to Config	DO:10	1-4 Refer to Configro
Relay 1-5	DO:11	1-5 Refer to Config	DO:11	1-5 Refer to Configro
Relay 1-6	DO:12	1-6 Refer to Config	DO:12	1-6 Refer to Configro
Relay 1-7	DO:13	1-7 Refer to Config	DO:13	1-7 Refer to Configro
Relay 1-8	DO:14	1-8 Refer to Config	DO:14	1-8 Refer to Configro
Relay 1-9	DO:15	1-9 Refer to Config	DO:15	1-9 Refer to Configro
Relay 1-10	DO:16	1-10 Refer to Config	DO:16	1-10 Refer to Configro
Relay 2-1	DO:17	2-1 Refer to Config	DO:17	2-1 Refer to Configro
Relay 2-2	DO:18	2-2 Refer to Config	DO:18	2-2 Refer to Configro
Relay 2-3	DO:19	2-3 Refer to Config	DO:19	2-3 Refer to Configro
Relay 2-4	DO:20	2-4 Refer to Config	DO:20	2-4 Refer to Configro

**18.13. BMS AO Information - MCS-BMS-GATEWAY**

**POINT MAPPING INFO THROUGH OPTIONAL MCS-BMS-GATEWAY**

MicroMag		BACnet IP		LONTALK	
PT#	ID	NAME	ID	NAME	
M-T	AO:1	M_T_TRIACSPARE	AO:1	M_T_TRIACSPARao	
Analog M-1	AO:2	M_1_Refer to Config	AO:2	M_1_Refer to Configao	
Analog M-2	AO:3	M_2_Refer to Config	AO:3	M_2_Refer to Configao	
Analog M-3	AO:4	M_3_Refer to Config	AO:4	M_3_Refer to Configao	
Analog M-4	AO:5	M_4_Refer to Config	AO:5	M_4_Refer to Configao	
Analog 1-1	AO:6	1-1 Refer to Config	AO:6	1-1 Refer to Configao	
Analog 1-2	AO:7	1-2 Refer to Config	AO:7	1-2 Refer to Configao	
Analog 1-3	AO:8	1-3 Refer to Config	AO:8	1-3 Refer to Configao	
Analog 1-4	AO:9	1-4 Refer to Config	AO:9	1-4 Refer to Configao	
Analog 2-1	AO:10	2-2 Refer to Config	AO:10	2-2 Refer to Configao	
Analog 2-2	AO:11	2-3 Refer to Config	AO:11	2-3 Refer to Configao	
Analog 2-3	AO:12	2-4 Refer to Config	AO:12	2-4 Refer to Configao	
Analog 2-4	AO:13	2-5 Refer to Config	AO:13	2-5Refer to Configao	

**18.14. BMS Unit Control - MCS-BMS-GATEWAY**

**POINT MAPPING INFO THROUGH OPTIONAL MCS-BMS-GATEWAY**

BACnet IP		LONTALK	
ID	NAME	ID	NAME
MV:0	Unit_State	MV:0	UnitState
MV:1	Occupation Mode	MV:1	Occupation Mode

BACnet IP		LONTALK	
ID	NAME	ID	NAME
MV:2	Network_Run_Stop	MV:2	Network_Run_Stop
MV:15	Cool_State	MV:15	Cool_State
MV:110	ALARM_1_DETAILS	MV:110	ALARM_1_DETAILS
MV:111	ALARM_2_DETAILS	MV:111	ALARM_2_DETAILS
MV:112	ALARM_3_DETAILS	MV:112	ALARM_3_DETAILS
MV:113	ALARM_4_DETAILS	MV:113	ALARM_4_DETAILS
MV:114	ALARM_5_DETAILS	MV:114	ALARM_5_DETAILS
MV:115	ALARM_1_DETAILS	MV:115	ALARM_1_DETAILS
MV:116	ALARM_2_DETAILS	MV:116	ALARM_2_DETAILS
MV:117	ALARM_3_DETAILS	MV:117	ALARM_3_DETAILS
MV:118	ALARM_4_DETAILS	MV:118	ALARM_4_DETAILS
MV:119	ALARM_5_DETAILS	MV:119	ALARM_5_DETAILS
MV:130	EXV_1_State	MV:130	EXV1State
MV:135	EXV_2_State	MV:135	EXV2State
MV:140	EXV_3_State	MV:140	EXV3State
MV:145	EXV_4_State	MV:145	EXV4State
MV:146	EXV_5_State	MV:146	EXV5State
MV:147	EXV_6_State	MV:147	EXV6State
AV:2001	Unit_State_Time	AV:2001	UnitStateTime
AV:2002	Unit_Cool_Enable	AV:2002	UnitCoolEnable
AV:2003	Cool_Target_Reset	AV:2003	CoolTargetReset
AV:2100	Cool_State_Time	AV:2100	CoolStateTime
AV:2101	Cool_Stages_Wanted	AV:2101	CoolStagesWanted
AV:2102	Cool_Stages_Active	AV:2102	CoolStagesActive
AV:2103	Cool_Target	AV:2103	CoolTarget
AV:2104	Cool_Control_SI	AV:2104	CoolControlSI
AV:2105	Cool_Wanted_Capacity	AV:2105	CoolWantedCapacity
AV:2106	Cool_Adjust_Delay	AV:2106	CoolAdjustDelay
AV:2107	Cool_ROC	AV:2107	CoolROC

**18.15. BMS Compressor/Condenser Points - MCS-BMS-GATEWAY**

**POINT MAPPING INFO THROUGH OPTIONAL MCS-BMS-GATEWAY**

BACnet IP		LONTALK	
ID	NAME	ID	NAME
MV:20	CP1_State	MV:20	CP1_State
MV:25	CP2_State	MV:25	CP2_State
MV:30	CP3_State	MV:30	CP3_State
MV:35	CP4_State	MV:35	CP4_State
MV:160	CP5_State	MV:160	CP5_State
MV:165	CP6_State	MV:165	CP6_State
MV:40	CD1_State	MV:40	CD1_State
MV:45	CD3_State	MV:45	CD3_State
MV:50	CD4_State	MV:50	CD4_State
MV:170	CD5_State	MV:170	CD5_State

BACnet IP		LONTALK	
ID	NAME	ID	NAME
MV:171	CD6_State	MV:171	CD6_State
AV:2150	Cond1_State_Time	AV:2150	Cond1StateTime
AV:2151	Cond1_Stages_Wanted	AV:2151	Cond1StagesWanted
AV:2152	Cond1_Stages_Active	AV:2152	Cond1StagesActive
AV:2153	Cond1_Target	AV:2153	Cond1Target
AV:2154	Cond1_Control_SI	AV:2154	Cond1ControlSI
AV:2155	Cond1_Wanted_Capacity	AV:2155	Cond1WantedCapacity
AV:2156	Cond1_Adjust_Delay	AV:2156	Cond1AdjustDelay
AV:2157	Cond1_ROC	AV:2157	Cond1ROC
AV:2250	Cond3_State_Time	AV:2250	Cond3StateTime
AV:2251	Cond3_Stages_Wanted	AV:2251	Cond3StagesWanted
AV:2252	Cond3_Stages_Active	AV:2252	Cond3StagesActive
AV:2253	Cond3_Target	AV:2253	Cond3Target
AV:2254	Cond3_Control_SI	AV:2254	Cond3ControlSI
AV:2255	Cond3_Wanted_Capacity	AV:2255	Cond3WantedCapacity
AV:2256	Cond3_Adjust_Delay	AV:2256	Cond3AdjustDelay
AV:2257	Cond3_ROC	AV:2257	Cond3ROC
AV:2300	Cond4_State_Time	AV:2300	Cond4StateTime
AV:2301	Cond4_Stages_Wanted	AV:2301	Cond4StagesWanted
AV:2302	Cond4_Stages_Active	AV:2302	Cond4StagesActive
AV:2303	Cond4_Target	AV:2303	Cond4Target
AV:2304	Cond4_Control_SI	AV:2304	Cond4ControlSI
AV:2305	Cond4_Wanted_Capacity	AV:2305	Cond4WantedCapacity
AV:2306	Cond4_Adjust_Delay	AV:2306	Cond4AdjustDelay
AV:2307	Cond4_ROC	AV:2307	Cond4ROC
AV:2320	Cond5_State_Time	AV:2320	Cond5StateTime
AV:2321	Cond5_Stages_Wanted	AV:2321	Cond5StagesWanted
AV:2322	Cond5_Stages_Active	AV:2322	Cond5StagesActive
AV:2323	Cond5_Target	AV:2323	Cond5Target
AV:2324	Cond5_Control_SI	AV:2324	Cond5ControlSI
AV:2325	Cond5_Wanted_Capacity	AV:2325	Cond5WantedCapacity
AV:2326	Cond5_Adjust_Delay	AV:2326	Cond5AdjustDelay
AV:2327	Cond5_ROC	AV:2327	Cond5ROC
AV:2330	Cond6_State_Time	AV:2330	Cond6StateTime
AV:2331	Cond6_Stages_Wanted	AV:2331	Cond6StagesWanted
AV:2332	Cond6_Stages_Active	AV:2332	Cond6StagesActive
AV:2333	Cond6_Target	AV:2333	Cond6Target
AV:2334	Cond6_Control_SI	AV:2334	Cond6ControlSI
AV:2335	Cond6_Wanted_Capacity	AV:2335	Cond6WantedCapacity
AV:2336	Cond6_Adjust_Delay	AV:2336	Cond6AdjustDelay
AV:2337	Cond6_ROC	AV:2337	Cond6ROC
AV:2450	Comp1_State_Time	AV:2450	Comp1StateTime
AV:2452	Comp1_Sat_Suction	AV:2452	Comp1SatSuction
AV:2454	Comp1_Sat_Dis_Temp	AV:2454	Comp1SatDisTemp
AV:2455	Comp1_Dis_SH	AV:2455	Comp1DisSH

BACnet IP		LONTALK	
ID	NAME	ID	NAME
AV:2456	Comp1_Oil_Diff	AV:2456	Comp1OilDiff
AV:2457	Comp1_Lead_Comp	AV:2457	Comp1LeadComp
AV:2500	Comp2_State_Time	AV:2500	Comp2StateTime
AV:2502	Comp2_Sat_Suction	AV:2502	Comp2SatSuction
AV:2504	Comp2_Sat_Dis_Temp	AV:2504	Comp2SatDisTemp
AV:2506	Comp2_Oil_Diff	AV:2506	Comp2OilDiff
AV:2507	Comp2_Lead_Comp	AV:2507	Comp2LeadComp
AV:2550	Comp3_State_Time	AV:2550	Comp3StateTime
AV:2557	Comp3_Lead_Comp	AV:2557	Comp3LeadComp
AV:2600	Comp4_State_Time	AV:2600	Comp4StateTime
AV:2607	Comp4_Lead_Comp	AV:2607	Comp4LeadComp
AV:2610	Comp5_State_Time	AV:2610	Comp5StateTime
AV:2617	Comp5_Lead_Comp	AV:2617	Comp5LeadComp
AV:2620	Comp6_State_Time	AV:2620	Comp6StateTime
AV:2627	Comp6_Lead_Comp	AV:2627	Comp6LeadComp

### 18.16. Writeable Network Points- MCS-BMS-GATEWAY

#### POINT MAPPING INFO THROUGH OPTIONAL MCS-BMS-GATEWAY

BACnet IP		LONTALK	
ID	NAME	ID	NAME
AV:2008	NETRN_ST	AV:2008	iNETRN_ST
AV:2009	NET_OCC_MODE	AV:2009	iNETOCCMODE

# Chapter - 19. BMS STATE LIST

## 19.1. CHILLER\_ALGO\_STATE\_LIST

MCS/MODBUS RTU	BACnet MS/TP	
Present Value	Present Value	State-Text
0	1	PowerUpDelay
1	2	MCS IO FAILED
2	3	MACH LOCKOUT
3	4	OFF SMOKE AL
4	5	OFF SCHEDULE
5	6	OFF SATISFIED
6	7	OFF NET STOP
7	8	OFF RUN/STOP
8	9	DIRECT SUPERV
9	10	EVAP FAN ONLY
10	11	COOLING
11	12	HEATING
12	13	DEHUMID
13	14	HEAT: HP ONLY
14	15	HEAT:HP + AUX
15	16	HEAT:AUX ONLY
16	17	HEAT:AUX+EMRG
17	18	HEAT:ALL
18	19	HEAT:EMERG
19	20	HEAT:PRIMARY
20	21	MORN WARM UP
21	22	COOL:HI HUMID
22	23	MORN COOLDOWN

## 19.2. BACNET\_MSV\_OCCUPATION\_MODE MSV:1

MCS/MODBUS RTU	BACnet MS/TP	
Present Value	Present Value	State-Text
0	1	OCCUPIED
1	2	UNOCCUPIED
2	3	OVERRIDE
3	4	SCHEDULE
4	5	GENERATOR

**19.3. BACNET\_MSV\_NETWORK\_RUN\_STOP MSV:2**

<b>MCS/MODBUS RTU</b>	<b>BACnet MS/TP</b>	
<b>Present Value</b>	<b>Present Value</b>	<b>State-Text</b>
0	1	STOP
1	2	RUN

**19.4. BACNET\_MSV\_EVAPORATOR\_STATE MSV:10**

## CHILLER cfg

<b>MCS/MODBUS RTU</b>	<b>BACnet MS/TP</b>	
<b>Present Value</b>	<b>Present Value</b>	<b>State-Text</b>
0	1	PUMP INIT
1	2	UNLDING AZ
2	3	LOADING AZ
3	4	HOLDING AZ
4	5	UNLDING BZ
5	6	LOADING BZ
6	7	HOLDING BZ
7	8	UNLDING IZ
8	9	LOADING IZ
9	10	HOLDING IZ
10	11	UNLD ROC
11	12	LOAD ROC
12	13	HOLD ROC
13	14	HOLD STAGE
14	15	HOLD STAGE
15	16	CAV CNTRL
16	17	PUMP ON
17	18	DISABLED
18	19	LOCKED OUT
19	20	POST DELAY
20	21	PRE DELAY
21	22	PUMP OFF
22	23	SUPERVISOR

**19.5. BACNET\_MSV\_COOLING / PRECOOLING STATES**

BACNET\_MSV\_COOLING\_STATE MSV:15

BACNET\_MSV\_PRECOOLING\_STATE MSV:90

MCS/MODBUS RTU	BACnet MS/TP	
Present Value	Present Value	State-Text
0	1	COOL ON
1	2	UNLDING AZ
2	3	LOADING AZ
3	4	HOLDING AZ
4	5	UNLDING BZ
5	6	LOADING BZ
6	7	HOLDING BZ
7	8	UNLDING IZ
8	9	LOADING IZ
9	10	HOLDING IZ
10	11	UNLD ROC
11	12	LOAD ROC
12	13	HOLD ROC
13	14	HOLD STAGE
14	15	HOLD STAGE
15	16	OFF&READY
16	17	DISABLED
17	18	NO FLOW
18	19	LOCKED OUT
19	20	N/A
20	21	SUPERVISOR
21	22	HOLD PCOOL
22	23	UNLD HIAMP
23	24	UNLD HITMP
24	25	HOLD HITMP

## 19.6. COMPRESSOR STATES

BACNET\_MSV\_COMPRESSOR\_1\_STATE MSV:20

BACNET\_MSV\_COMPRESSOR\_2\_STATE MSV:25

BACNET\_MSV\_COMPRESSOR\_3\_STATE MSV:30

BACNET\_MSV\_COMPRESSOR\_4\_STATE MSV:35

BACNET\_MSV\_COMPRESSOR\_5\_STATE MSV:160

BACNET\_MSV\_COMPRESSOR\_6\_STATE MSV:165

MCS/MODBUS RTU	BACnet MS/TP	
Present Value	Present Value	State-Text
0	1	LOST IO
1	2	SAFETY TRP
2	3	LOCKOUT
3	4	DISABLED
4	5	OFF:LowAmb
5	6	OFF: DEHUM
6	7	PUMPDOWN
7	8	ANTI CYCLE
8	9	OFF&READY
9	10	REVERSING
10	11	START-UP
11	12	RUNNING
12	13	DEFROSTING
13	14	SucPsiHOLD
14	15	SucPsiUNLD
15	16	DisPsiUNLD
16	17	DisPsiHOLD
17	18	UNLD LOTMP
18	19	HOLD LOTMP
19	20	HOLD HIAMP
20	21	DIS TMPHLD
21	22	HOLD HIWTR
22	23	UNLD HIAMP
23	24	UNLD HITMP
24	25	HOLD HITMP
25	26	DIS TmUNLD
26	27	DisSH UNLD
27	28	DisSH HOLD
28	29	FreezeUNLD
29	30	FreezeHOLD
30	31	CMP @ 100%



**19.7. CONDENSER STATES**

BACNET\_MSV\_CONDENSER\_1\_STATE MSV:40

BACNET\_MSV\_CONDENSER\_2\_STATE MSV:45

BACNET\_MSV\_CONDENSER\_3\_STATE MSV:50

BACNET\_MSV\_CONDENSER\_4\_STATE MSV:55

BACNET\_MSV\_CONDENSER\_5\_STATE MSV:170

BACNET\_MSV\_CONDENSER\_6\_STATE MSV:171

<b>MCS/MODBUS RTU</b>	<b>BACnet MS/TP</b>	
<b>Present Value</b>	<b>Present Value</b>	<b>State-Text</b>
0	1	COND INIT
1	2	UNLDING AZ
2	3	LOADING AZ
3	4	HOLDING AZ
4	5	UNLDING BZ
5	6	LOADING BZ
6	7	HOLDING BZ
7	8	UNLDING IZ
8	9	LOADING IZ
9	10	HOLDING IZ
10	11	UNLD ROC
11	12	LOAD ROC
12	13	HOLD ROC
13	14	HOLD STAGE
14	15	HOLD STAGE
15	16	DISABLED
16	17	NO FLOW
17	18	LOCKED OUT
18	19	COND OFF
19	20	N/A

**19.8. HEATING / IGNITION STATES - RTU ONLY**

BACNET\_MSV\_HEATING\_STATE MSV:60

BACNET\_MSV\_IGNITION\_1\_STATE MSV:70

BACNET\_MSV\_IGNITION\_2\_STATE MSV:75

BACNET\_MSV\_IGNITION\_3\_STATE MSV:80

BACNET\_MSV\_IGNITION\_4\_STATE MSV:85

BACNET\_MSV\_IGNITION\_5\_STATE MSV:86

BACNET\_MSV\_IGNITION\_6\_STATE MSV:87

<b>MCS/MODBUS RTU</b>	<b>BACnet MS/TP</b>	<b>State-Text</b>
<b>Present Value</b>	<b>Present Value</b>	
0	1	HEAT INIT
1	2	UNLDING AZ
2	3	LOADING AZ
3	4	HOLDING AZ
4	5	UNLDING BZ
5	6	LOADING BZ
6	7	HOLDING BZ
7	8	UNLDING IZ
8	9	LOADING IZ
19	10	HOLDING IZ
10	11	UNLD ROC
11	12	LOAD ROC
12	13	HOLD ROC
13	14	HOLD STAGE
14	15	HOLD STAGE
15	16	IGNITION
16	17	WARMING UP
17	18	OPERATING
18	19	HOLD IGNTN
19	20	OFF&READY
20	21	DISABLED
21	22	NO FLOW
22	23	LOCKED OUT
23	24	N/A
24	25	SUPERVISOR
25	26	SAFETY TRP
26	27	HI AMBIENT

**19.9. REHEAT STATE - RTU ONLY**

BACNET\_MSV\_REHEAT\_STATE MSV:65

<b>MCS/MODBUS RTU</b>	<b>BACnet MS/TP</b>	
<b>Present Value</b>	<b>Present Value</b>	<b>State-Text</b>
0	1	REHEAT INI
1	2	UNLDING AZ
2	3	LOADING AZ
3	4	HOLDING AZ
4	5	UNLDING BZ
5	6	LOADING BZ
6	7	HOLDING BZ
7	8	UNLDING IZ
8	9	LOADING IZ
9	10	HOLDING IZ
10	11	UNLD ROC
11	12	LOAD ROC
12	13	HOLD ROC
13	14	HOLD STAGE
14	15	HOLD STAGE
15	16	OFF&READY
16	17	DISABLED
17	18	NO FLOW
18	19	LOCKED OUT
19	20	N/A

**19.10. ECONOMIZER STATE**

BACNET\_MSV\_ECONOMIZER\_STATE MSV:95

<b>MCS/MODBUS RTU</b>	<b>BACnet MS/TP</b>	
<b>Present Value</b>	<b>Present Value</b>	<b>State-Text</b>
0	1	OFF AND CLOSED
1	2	AT MIN OPEN %
2	3	AT HI CO2 OPEN %
3	4	ECON ON - NORMAL
4	5	ECON ON - HI CO2
5	6	OUTDR DMPR OPEN
6	7	OUTDR DMPR OFF
7	8	ECON ON--HOOD ON
8	9	EXHAUST HOOD ON
9	10	BLDG PSI CONTROL

**19.11. EXHAUST STATE**

BACNET\_MSV\_EXHAUST\_STATE MSV:100

<b>MCS/MODBUS RTU</b>	<b>BACnet MS/TP</b>	
<b>Present Value</b>	<b>Present Value</b>	<b>State-Text</b>
0	1	CTRL INIT
1	2	UNLDING AZ
2	3	LOADING AZ
3	4	HOLDING AZ
4	5	UNLDING BZ
5	6	LOADING BZ
6	7	HOLDING BZ
7	8	UNLDING IZ
8	9	LOADING IZ
9	10	HOLDING IZ
10	11	UNLD ROC
11	12	LOAD ROC
12	13	HOLD ROC
13	14	HOLD STAGE
14	15	HOLD STAGE
15	16	OFF&READY
16	17	DISABLED
17	18	NO FLOW
18	19	LOCKED OUT
19	20	N/A
20	21	HOOD ON

**19.12. EXV STATES**

BACNET\_MSV\_EXV\_1\_STATE MSV:130

BACNET\_MSV\_EXV\_2\_STATE MSV:135

BACNET\_MSV\_EXV\_3\_STATE MSV:140

BACNET\_MSV\_EXV\_4\_STATE MSV:145

BACNET\_MSV\_EXV\_5\_STATE MSV:150

BACNET\_MSV\_EXV\_6\_STATE MSV:155

<b>MCS/MODBUS RTU</b>	<b>BACnet MS/TP</b>	
<b>Present Value</b>	<b>Present Value</b>	<b>State-Text</b>
0	1	EXV CLOSED
1	2	PrePmpDown
2	3	EXV HLDING
3	4	EXV START
4	5	EXV OPNING
5	6	EXV CLSING
6	7	Low SuprHt
7	8	OPENING 4X
8	9	OPENING 2X
9	10	LoSuctOpen
10	11	CLOSING 2X
11	12	CLOSING 4X
12	13	MOP CLSING
13	14	MOP HLDING

## Chapter - 20. BMS COMMUNICATION PROTOCOLS

**BMS WILL ONLY SHOW 5 OF THE LATEST ALARMS AND THE ALARMS DETAIL WHICH WAS CREATED BY THE MICROMAG CONTROLLER.**

BMS Communication Protocols					
<input type="radio"/> SI Points <input type="radio"/> RO Points <input type="radio"/> AO Points <input type="radio"/> Setpoint Values <input checked="" type="radio"/> Unit Control Info <input type="radio"/> Compressor Points <input type="radio"/> Writable Points					
Unit Control Info					
POINT MAPPING INFO BUILT IN MCS-MICROMAG					
MCS-MICROMAG		BACNET MSTP		MODBUS RTU	
1	ALARM 1 NAME	MV:110	ALARM 1 NAME	46110	0
2	ALARM 2 NAME	MV:111	ALARM 2 NAME	46111	0
3	ALARM 3 NAME	MV:112	ALARM 3 NAME	46112	0
4	ALARM 4 NAME	MV:113	ALARM 4 NAME	46113	0
5	ALARM 5 NAME	MV:114	ALARM 5 NAME	46114	0
6	ALARM 1 DETAILS	MV:115	ALARM 1 DETAILS	46115	0
7	ALARM 2 DETAILS	MV:116	ALARM 2 DETAILS	46116	0
8	ALARM 3 DETAILS	MV:117	ALARM 3 DETAILS	46117	0
9	ALARM 4 DETAILS	MV:118	ALARM 4 DETAILS	46118	0
10	ALARM 5 DETAILS	MV:119	ALARM 5 DETAILS	46119	0

### 19.13. Reading Alarm Points For MicroMag

**For the Building Management System(BMS) to read MicroMag alarms, please reference the charts on the following pages.**

First look for '**ALARM NAME**' and compare the value received from the BMS to the chart named Alarm Name. This will tell you what the alarm is. Then look at the Alarm Detail and compare the value to the chart titled Alarm detail.

This will tell you the number of the referenced component, Setpoint, Sensor Input, Relay Output, or Analog Output that is associated with that alarm.

If an alarm occurs that is NOT associated with a board point, Setpoint, Sensor Input, Relay Output, or Analog Output, **THEN THE ALARM DETAIL SHOULD BE A '1' for N/A.**

**Examples:**

***There is a lockout reset performed:***

Alarm Name = LCKOUT RESET which is a value of 18 Alarm Detail = N/A which is a value of 1  
 If an alarm occurs that is associated with a board point, compressor, condenser, Setpoint, or any other  
 numbered object then the Alarm Detail will be a numerical value from 2-334

(See page 86 for Alarm Name)

(See page 88 for Alarm Detail)

#	ALARM NAME
18	LCKOUT RESET

#	ALARM DETAIL
1	N/A

**Explanation:**

A Lockout Reset was performed

**SI Fault Example:**

There is an SI fault on the MicroMag at location M-8 Alarm Name = SI FLT @ which is a value of 12  
 Alarm Detail = M-8 which is a value of 159

**Compressor Fault Example:**

(See page 86 for Alarm Name)

(See page 92 for Alarm Detail)

#	ALARM NAME
12	SI FLT @

#	ALARM DETAIL
159	M-8

**Explanation:**

Sensor Fault at M8 main board

There is a compressor #3 fault.

Alarm Name = CMP Fault which is a value of 27 - Alarm Detail = #3 which is a value of 4

**Setpoint Change Example:**

(See page 86 for Alarm Name)

(See page 88 for Alarm Detail)

#	ALARM NAME
27	CPM FAULT

#	ALARM DETAIL
4	#3

**Explanation:**

Compressor Fault #3 - Check  
 History to determine fault at time  
 of the alarm

There is a Setpoint change at Setpoint #99 Alarm Name = StptChg: which is a value of 7 -  
 Alarm Detail = #99 which is a value of 100.

(See page 86 for Alarm Name)

(See page 90 for Alarm Detail)

#	ALARM NAME
7	StptChg

#	ALARM DETAIL
100	#99

**Explanation:**

Setpoint #99 was changed

MCS-CONNECT monitoring a MICROMAG Controller will show 100 of the latest alarms created by the MICROMAG Controller.

## Chapter - 21. MICROMAG BMS ALARMS

MicroMag generates 73 different alarms as shown below. In the first column of the table below, MicroMag starts its numbering with '0' which is 'NO ALARM'. BACnet present value number starts with '1'.

**(BACnet will display a number one ahead of the number MicroMag is displaying)**

BACNET\_MSV\_ALARM\_1\_STATE MSV:110

BACNET\_MSV\_ALARM\_2\_STATE MSV:111

BACNET\_MSV\_ALARM\_3\_STATE MSV:112

BACNET\_MSV\_ALARM\_4\_STATE MSV:113

BACNET\_MSV\_ALARM\_5\_STATE MSV:114

MCS/MODBUS RTU	BACnet MS/TP	
Present Value	Present Value	State-Text
0	1	NO ALARM
1	2	UNIT PWR ON
2	3	CYC CT RESET
3	4	RO CHG @
4	5	AO CHG @
5	6	SI CHG @
6	7	StptChg:
7	8	COMM: MCSIO
8	9	COMM: MODBUS
9	10	COMM: BACnet
10	11	PNT INFO CLR
11	12	SI FLT @
12	13	EE WRITE ERR
13	14	MCS IO RESET
14	15	AUTH CODE:
15	16	NET RUN/STOP
16	17	NET OCCUPIED
17	18	LCKOUT RESET
18	19	ALARMS CLEAR
19	20	RO 1 OFFLINE
20	21	RO 2 OFFLINE
21	22	SI 1 OFFLINE
22	23	SI 2 OFFLINE
23	24	EVAP FAN FLT
24	25	NO CMP PRF
25	26	HI MTR TMP
26	27	CMP FAULT
27	28	UNSAFE SUC
28	29	LO SUC PSI
29	30	LO SUC SHT



<b>MCS/MODBUS RTU</b>	<b>BACnet MS/TP</b>	
<b>Present Value</b>	<b>Present Value</b>	<b>State-Text</b>
30	31	HI SUC SHT
31	32	LO DIS PSI
32	33	HI DIS PSI
33	34	HI DIS TMP
34	35	LO DIS SHT
35	36	LO PSI DIF
36	37	UNS PSI DIFF
37	38	OIL LEVEL
38	39	HI OIL TMP
39	40	HIGH AMPS
40	41	LOW AMPS
41	42	PUMP DOWN
42	43	CFG INVALID
43	44	CndFLT @
44	45	HI PSI SW
45	46	LO PSI SW
46	47	HTR FAULT
47	48	HI SupplyTmp
48	49	PHASE LOSS
49	50	HI BLDG PSI
50	51	FILTER CLOG
51	52	CFG RECEIVED
52	53	SMOKE ALARM
53	54	IGNITION FLT
54	55	SPLY FREEZE
55	56	PRECL FREEZE
56	57	NO FLOW
57	58	EMERG. STOP
58	59	STAT OFFLINE
59	60	NO BATTERY
60	61	HI DUCT PSI
61	62	FIRE ALARM
62	63	CONDENSATION
63	64	SWITCHED OFF
64	65	OAD FAULT
65	66	Mod-InputChg
66	67	ModAnalogChg
67	68	Mod-RelayChg
68	69	Mod-ConstChg
69	70	ModConfigChg
70	71	ERW ALARM
71	72	Aux Heat FLT
72	73	PrcsPump FLT
73	74	Low Oil LVL

### 21.1. MICROMAG ALARMS DETAILS REFERENCE NUMBERS

The below table shows 'ALARMS DETAILS REFERENCE NUMBERS.

BACNET\_MSV\_ALARM\_1\_TEXT\_STATE MSV:115

BACNET\_MSV\_ALARM\_2\_TEXT\_STATE MSV:116

BACNET\_MSV\_ALARM\_3\_TEXT\_STATE MSV:117

BACNET\_MSV\_ALARM\_4\_TEXT\_STATE MSV:118

BACNET\_MSV\_ALARM\_5\_TEXT\_STATE MSV:119

MCS/MODBUS RTU	BACnet MS/TP		MicroMag / Set-points /Exp Brds
Present Value	Present Value	State-Text	
0	1	N/A	
1	2	1	
2	3	2	
3	4	3	
4	5	4	
5	6	5	
6	7	6	
7	8	7	
8	9	8	
9	10	9	
10	11	10	
11	12	11	
12	13	12	
13	14	13	
14	15	14	
15	16	15	
16	17	16	
17	18	17	
18	19	18	
19	20	19	
20	21	20	
21	22	21	
22	23	22	
23	24	23	
24	25	24	
25	26	25	
26	27	26	
27	28	27	
28	29	28	
29	30	29	
30	31	30	
31	32	31	

<b>MCS/MODBUS RTU</b>	<b>BACnet MS/TP</b>		<b>MicroMag / Set-points /Exp Brds</b>
<b>Present Value</b>	<b>Present Value</b>	<b>State-Text</b>	
32	33	32	
33	34	33	
34	35	34	
35	36	35	
36	37	36	
37	38	37	
38	39	38	
39	40	39	
40	41	40	
41	42	41	
42	43	42	
43	44	43	
44	45	44	
45	46	45	
46	47	46	
47	48	47	
48	49	48	
49	50	49	
50	51	50	
51	52	51	
52	53	52	
53	54	53	
54	55	54	
55	56	55	
56	57	56	
57	58	57	
58	59	58	
59	60	59	
60	61	60	
61	62	61	
62	63	62	
63	64	63	
64	65	64	
65	66	65	
66	67	66	
67	68	67	
68	69	68	
69	70	69	
70	71	70	
71	72	71	

<b>MCS/MODBUS RTU</b>	<b>BACnet MS/TP</b>		<b>MicroMag / Set-points /Exp Brds</b>
<b>Present Value</b>	<b>Present Value</b>	<b>State-Text</b>	
72	73	72	
73	74	73	
74	75	74	
75	76	75	
76	77	76	
77	78	77	
78	79	78	
79	80	79	
80	81	80	
81	82	81	
82	83	82	
83	84	83	
84	85	84	
85	86	85	
86	87	86	
87	88	87	
88	89	88	
89	90	89	
90	91	90	
91	92	91	
92	93	92	
93	94	93	
94	95	94	
95	96	95	
96	97	96	
97	98	97	
98	99	98	
99	100	99	
100	101	100	
101	102	101	
102	103	102	
103	104	103	
104	105	104	
105	106	105	
106	107	106	
107	108	107	
108	109	108	
109	110	109	

<b>MCS/MODBUS RTU</b>	<b>BACnet MS/TP</b>		<b>MicroMag / Set-points /Exp Brds</b>
<b>Present Value</b>	<b>Present Value</b>	<b>State-Text</b>	
110	111	110	
111	112	111	
112	113	112	
113	114	113	
114	115	114	
115	116	115	
116	117	116	
117	118	117	
118	119	118	
119	120	119	
120	121	120	
121	122	121	
122	123	122	
123	124	123	
124	125	124	
125	126	125	
126	127	126	
127	128	127	
128	129	128	
129	130	129	
130	131	130	
131	132	131	
132	133	132	
133	134	133	
134	135	134	
135	136	135	
136	137	136	
137	138	137	
138	139	138	
139	140	139	
140	141	140	
141	142	141	
142	143	142	
143	144	143	
144	145	144	
145	146	145	
146	147	146	
147	148	147	
148	149	148	

MCS/MODBUS RTU	BACnet MS/TP		MicroMag / Set-points /Exp Brds
Present Value	Present Value	State-Text	
149	150	149	
150	151	150	
151	152	M-1	<b>SENSOR INPUTS</b> Alarm Details V12 <b>MicroMag</b> Main Board
152	153	M-2	
153	154	M-3	
154	155	M-4	
155	156	M-5	
156	157	M-6	
157	158	M-7	
158	159	M-8	
159	160	M-9	
160	161	M-10	
161	162	1-1	<b>SENSOR INPUTS</b> Alarm Details V12 <b>Micro-SI8-A04</b> Old Expansion Board #1
162	163	1-2	
163	164	1-3	
164	165	1-4	
165	166	1-5	
166	167	1-6	
167	168	1-7	
168	169	1-8	
169	170	2-1	<b>SENSOR INPUTS</b> Alarms Details V12 <b>Micro-SI8-A04</b> Old Expansion Board #2
170	171	2-2	
171	172	2-3	
172	173	2-4	
173	174	2-5	
174	175	2-6	
175	176	2-7	
176	177	2-8	
177	178	M-T	<b>ANALOG OUTPUTS</b> Alarms Details V12-V18 <b>MicroMag</b> Main Board
178	179	M-1	
179	180	M-2	
180	181	M-3	
181	182	M-4	<b>ANALOG OUTPUTS</b> Alarms Details V12-V18 <b>Micro-SI8-A04</b> Exp. Board #1
182	183	1-1	
183	184	1-2	
184	185	1-3	
185	186	1-4	<b>ANALOG OUTPUTS</b> Alarms Details V12-V18 <b>Micro-SI8-A04</b> Exp. Board #2
186	187	2-1	
187	188	2-2	
188	189	2-3	
189	190	2-4	

<b>MCS/MODBUS RTU</b>	<b>BACnet MS/TP</b>		<b>MicroMag / Set-points /Exp Brds</b>
<b>Present Value</b>	<b>Present Value</b>	<b>State-Text</b>	
190	191	M-1	<b>RELAY OUTPUTS</b> Alarms Details V12 <b>MicroMag</b> Main Board
191	192	M-2	
192	193	M-3	
193	194	M-4	
194	195	M-5	
195	196	M-6	
196	197	1-1	<b>RELAY OUTPUTS</b> Alarms Details V12 <b>Micro RO6</b> Old Exp. Board. #1
197	198	1-2	
198	199	1-3	
199	200	1-4	
200	201	1-5	
201	202	1-6	
202	203	2-1	<b>RELAY OUTPUTS</b> Alarms Details V12 <b>Micro RO6</b> Old Exp. Board #2
203	204	2-2	
204	205	2-3	
205	206	2-4	
206	207	2-5	
207	208	2-6	
208	209	M-1	<b>SENSOR INPUTS</b> Alarms Details V18 <b>MicroMag</b> Main Board
209	210	M-2	
210	211	M-3	
211	212	M-4	
212	213	M-5	
213	214	M-6	
214	215	M-7	
215	216	M-8	
216	217	M-9	
217	218	M-10	
218	219	1-1	<b>SENSOR INPUTS</b> Alarm Details V18 <b>MCS-SI-Base</b> Expansion Board
219	220	1-2	
220	221	1-3	
221	222	1-4	
222	223	1-5	
223	224	1-6	
224	225	1-7	
225	226	1-8	
226	227	1-9	
227	228	1-10	
228	229	1-11	
229	230	1-12	

<b>MCS/MODBUS RTU</b>	<b>BACnet MS/TP</b>		<b>MicroMag / Set-points /Exp Brds</b>
<b>Present Value</b>	<b>Present Value</b>	<b>State-Text</b>	
230	231	1-13	<b>SENSOR INPUTS</b> Alarm Details V18 <b>MCS-SI-Base</b> Exp, Board
231	232	1-14	
232	233	1-15	
233	234	1-16	
234	235	2-1	<b>SENSOR INPUTS</b> Alarm Details V18 <b>MCS-SI-EXT</b> Exp, Board Mounted to SI-Base
235	236	2-2	
236	237	2-3	
237	238	2-4	
238	239	2-5	
239	240	2-6	
240	241	2-7	
241	242	2-8	
242	243	2-9	
243	244	2-10	
244	245	2-11	
245	246	2-12	
246	247	2-13	
247	248	2-14	
248	249	2-15	
249	250	2-16	
250	251	V-1	
251	252	V-2	
252	253	V-3	
253	254	V-4	
254	255	V-5	
255	256	V-6	
256	257	V-7	
257	258	V-8	
258	259	M-1	
259	260	M-2	<b>RELAY OUTPUTS</b> Alarm Details V18 <b>MicroMag</b> Main Board
260	261	M-3	
261	262	M-4	
262	263	M-5	
263	264	M-6	
264	265	1-1	
265	266	1-2	<b>RELAY OUTPUTS</b> Alarm Details V18 <b>MCS-RO-BASE</b> Expansion Board
266	267	1-3	
267	268	1-4	
268	269	1-5	
269	270	1-6	



<b>MCS/MODBUS RTU</b>	<b>BACnet MS/TP</b>		<b>MicroMag / Set-points /Exp Brds</b>
<b>Present Value</b>	<b>Present Value</b>	<b>State-Text</b>	
270	271	1-7	<b>RELAY OUTPUTS</b> Alarm Details V18
271	272	1-8	
272	273	1-9	
273	274	1-10	<b>MCS-RO-BASE</b> Expansion Board
274	275	2-1	<b>RELAY OUTPUTS</b> Details V18 <b>MCS-RO-EXT</b> Expansion Board Mounted to Base
275	276	2-2	
276	277	2-3	
277	278	2-4	
278	279	2-5	
279	280	2-6	
280	281	2-7	
281	282	2-8	
282	283	2-9	
283	284	2-10	
284	285	151	
285	286	152	
286	287	153	
287	288	154	
288	289	155	
289	290	156	
290	291	157	
291	292	158	
292	293	159	
293	294	160	
294	295	161	
295	296	162	
296	297	163	
297	298	164	
298	299	165	
299	300	166	
300	301	167	
301	302	168	
302	303	169	
303	304	170	
304	305	171	
305	306	172	
306	307	173	
307	308	174	
308	309	175	
309	310	176	

<b>MCS/MODBUS RTU</b>	<b>BACnet MS/TP</b>		<b>MicroMag / Set-points /Exp Brds</b>
<b>Present Value</b>	<b>Present Value</b>	<b>State-Text</b>	
310	311	177	
311	312	178	
312	313	179	
313	314	180	
314	315	181	
315	316	182	
316	317	183	
317	318	184	
318	319	185	
319	320	186	
320	321	187	
321	322	188	
322	323	189	
323	324	190	
324	325	191	
325	326	192	
326	327	193	
327	328	194	
328	329	195	
329	330	196	
330	331	197	
331	332	198	
332	333	199	
333	334	200	
334	335	201	

## Chapter - 21. TROUBLESHOOTING QUICK REFERENCE

PROBLEM	POTENTIAL SOLUTION
No Sensor + 5 vdc or sensor +5 vdc output is less than 4.90 vdc.	Indicates a possible shorted input sensor Remove all sensor terminal blocks. Wait about 15 seconds. If + 5 vdc returns, replace one sensor wire at a time until the + 5 vdc is lost again. This will be the shorted sensor.
A Sensor Input reads -99.9	This indicates an open Sensor Input signal or 5 VDC problem. Check sensor wiring for missing wire or poor connection. Check for faulty sensor. Check + 5 vdc on Sensor Input to ground. If less than 5 VDC is on the sensor 5 VDC terminal block, the problem is probably a shorted sensor. (A poly fuse protects the board) Remove all Sensor Input terminals. Wait about 15 seconds or until 5 VDC restored at Sensor Input. Connect terminals 1 at time until short reappears and fix bad sensor.
A Sensor Input reads +999.9	This indicates a shorted Sensor Input signal. Check sensor wiring for +5VDC shorted to signal etc. Check for faulty sensor.
A pressure sensor is reading more than 1 psi off (The temperature and humidity sensors do not require calibration.)	This indicates the transducer Sensor Input needs to be calibrated through the offset capability in the software. (Transducers by design need to be calibrated based on construction and altitude.) You can use the MCS-CONNECT with a valid Authorization code to change sensor offsets or from MicroMag Keypad. See MCS-CONNECT Interactive section for instructions. (Change SI Status, Manual Value and / or offset.)
Invalid reading on one Sensor Input.	This indicates an input problem with 1 sensor. Verify jumper settings correct for that SI.
Lost I/O	Indicates communications problem. Verify RS485 LED blinking. Verify termination jumper J6 only on at Magnum and last I/O. Verify Magnum and I/O address's set correctly. Verify wiring from Magnum to each I/O correct. Check fuses/120 VAC on I/O units
MCS-CONNECT cannot make changes	This indicates you are not at a proper authorization level. Follow steps below for proper authorization From either the SITE INFO or STATUS screen in MCS-CONNECT, click the 'View Only' button at the top of the screen, or click on the 'Passwords' menu option on the lower right of your Keypad/LCD display. Follow prompts and enter a valid 4-digit authorization number. The authorization level is displayed at the top of the display and is reflected by the color of the Authorization button. Red = View Only Light Blue = User level Purple = Service level Dark Blue = Supervisor level Green = Factory level

PROBLEM	POTENTIAL SOLUTION
Invalid authorization	This indicates an invalid authorization number. Follow steps below for proper authorization Press Menu key until the Password option appears Press the Enter key Follow the instructions in this manual. Section in Keypad labeled Enter Passwords.
SI from AMPS board 10 A low.	This indicates a problem with this SI only. Jumper setting on this SI in wrong position. Incorrect sensor type used.
INVALID CONFIG VER	Indicates layout of CFG wrong. CFG layout for different version than software
INVALID CONFIG TYPE	Indicates CFG incompatible with software.
INVALID CONFIG CHECKSUM	Indicates Checksum invalid Reload a valid CFG
Sensor input believed invalid	Verify Berg jumpers using Quick Reference Sheets Check wiring of sensor
Communications to MCS-485-GATEWAY from MCS-CONNECT not working.	Verify red LED on the gate way is blinking. This indicates that MCS-CONNECT is talking to the gateway. Verify that the two wire shielded cable is properly wired from the RS-485 connector to the gateway. Verify red LED (Located just to the left of the RS-485 connector on the Magnum board is blinking. This indicates that the Magnum is responding to the gateway. If both of these LED are blinking, check the address of the Magnum and any other Magnums that are on the network. Each must have a unique address. This address can be changed from the Magnum. Proper authorization is required. Enter the UNIT INFORMATION screen by pressing the SERVICE DIAGNOSTIC key and scrolling to this item. Press the enter key and scroll to the NETWORK ADDRESS screen. Change address if needed. Verify + 12 vdc to MCS-485-GATEWAY
INVALID CONFIG	Indicates Checksum invalid Either set to factory defaults on reset settings.

## Chapter - 22. MicroMag RTU Setpoints

Setpoint Information Screen (MicroMag-V18)																
		ECO = Economizer		EXHS = Exhaust		HP = Heat Pump										
		EVP = Evaporator		ERW = Energy Recovery Wheel		HD = High Discharge										
#	Name	Value	Min	Max	Adjust Value	Time (SEC)	Max Time Allowed (SEC)	Lockout Delay (HRS)	Safety Down Time(MIN)	Active or Non-Active	Select Value: # decimals & print char	Level Of Auth. To Display	Type of Setpoint	SEC to Ignore Safety	Window to Ext. Safety Time(SEC)	Safety Time Ext. (SEC)
8	COOL TARGET	24	20	28	0.1	---	---	---	---	Active	TEMP	View Only	Target	---	---	---
9	CoolStepDely	60	30	300	5	---	---	---	---	Active	SECONDS	View Only	Delay	---	---	---
10	HEAT TARGET	30	18	40	0.1	---	---	---	---	Active	TEMP	View Only	Target	---	---	---
11	HeatStepDely	120	30	500	5	---	---	---	---	Active	SECONDS	View Only	Delay	---	---	---

- ▶ **# (Number)** – From 1 to 200 (maximum number of Setpoints supported). Only active Setpoints will be displayed in MCS-CONNECT and on the keypad display.
- ▶ **Name** – The Setpoint’s name consists of up to 12 characters. The name is displayed following the number on the LCD display. The Setpoint name cannot be changed in the MICROMAG.
- ▶ **Value** – The value or target of the Setpoint. With proper authorization this value can be changed, within limits that have been established in MCS-Config.
- ▶ **Min** – The minimum value that can be set. This field is not displayed and cannot be changed in MCS-CONNECT or in the keypad display.
- ▶ **Max** – The maximum value that can be set. This field is not displayed and cannot be changed in MCS-CONNECT or in the keypad display.
- ▶ **Adjust Value** – The interval that the value field can be changed by. This field is not displayed and cannot be changed in MCS-CONNECT or in the keypad display.
- ▶ **Time (sec)** – this field has two purposes:  
 In either a LOCKOUT or ALARM type; this is the length of time the Setpoint must be true before it will trip. This time is always in seconds and it is displayed on the keypad display and MCS-CONNECT if the Setpoint is either a LOCKOUT or ALARM type. This field can be changed in MCS-CONNECT and through the keypad.  
 In a non-safety type Setpoint this field can be used as an extra timer. This will be specified in the Setpoint definition if it is used.
- ▶ **Max Time Allowed (SEC)** – Maximum time in seconds that the unit can run before lockout.
- ▶ **Lockout Delay Hrs.** – If a second safety occurs within this time, the unit or compressor will be locked out. This field is not displayed and cannot be changed through MCS-CONNECT or in the keypad display.
- ▶ **Safety Down Time (min.)** – After the first safety occurs the MicroMag will wait this number of minutes before the unit or associated compressor is allowed to run again.
- ▶ **Active or Non-Active** – Only active Setpoints will be displayed in MCS-CONNECT or on the keypad display, but only if the needed authorization level has been achieved.
- ▶ **Select Value: # decimals and print char** – This indicates the number of decimal places and the unit character that accompanies the value displayed. The number of decimal places is crucial when the Value, Minimum, and Maximum data is entered in MCS-Config.
- ▶ **Level of Auth. To Display** – This column indicates what authorization level a user must have in order to view the Setpoint from MCS-CONNECT or the keypad display.
- ▶ **Type of Setpoint** – This column indicates what type of setpoint, ‘Setpoint, Alarm, Lockout, Time, Target, Delay, Enable, Minimum Capacity or Warning’.
- ▶ **SEC to Ignore Safety** – This is the time in seconds to ignore or the associated safety at compressor start up.
- ▶ **Window to Ext. Safety Time (SEC)** – This value in seconds is the time window when the compressor starts that the safety time extension is added to the safety time(sec) value.
- ▶ **Safety Time Ext. (SEC)** – This value is the time that is added to the time(sec) value during the window to extend safety time(sec) time.

## 22.1. Setpoint Types

There are nine different types of Setpoints. The MicroMag software determines if a Setpoint contains a target value or is a safety. If it is a safety then its type determines what action the MicroMag will take when the safety occurs (either locking out the unit or generating an alarm only).

**NOTE: YOU WILL NOTICE THAT WHEN YOU CHOOSE THE ‘TYPE OF SETPOINT’, CERTAIN COLUMNS WILL BECOME ACTIVE WHILE OTHER COLUMNS ARE INACTIVE.**

### 22.1.1 SETPOINT

This type of Setpoint contains a target or provides information for some action. The time element in this type can be used for an additional counter if specified. This time is not displayed and cannot be changed through MCS-CONNECT or from the keypad display.

Name	Value	Min	Max	Adjust Value	Type of Setpoint
COOL ENABLE	22	18	29	0.1	Setpoint

Above columns are active when ‘SETPOINT’ is type, other columns cannot be changed

### 22.1.2 LOCKOUT

This type of Setpoint contains a safety value and the time that the safety must be violated before the safety will trip. Once a safety has tripped the MicroMag will take the appropriate action, shutting down the entire package or an individual compressor depending on the purpose of the safety. The MicroMag will then wait the Safety Down Time contained in that Setpoint before trying to return the normal. If successful, the system will continue to operate. If a second trip occurs on the same Setpoint with in the Lock Out Delay Time that is contained in that Setpoint the system will move to a LOCKOUT state. If the lockout delay time is set to zero the lockout will occur on the first trip. This requires manual intervention to reset the system. With each safety trip, the MicroMag will generate an alarm; refer to section 8 MicroMag Alarms and Safeties.

**Sec. to ignore safety** - If this value is not zero, at compressor startup this safety will be ignored for the time in this field.

**Window to extend Safety ‘Time (sec)’** – If this value is not zero, at compressor startup the normal Safety Time will be increased by the value in Safety Time Extension field for the time specified in this field.

**Safety Time Extension (Sec)** – This is the value that will be added to the Safety Time during the Window to extend Safety Time period.

Name	Value	Min	Max	Adjust Value	Time (SEC)	Max Time Allowed (SEC)	Lockout Delay (HRS)	Safety Down Time(MIN)	Type of Setpoint	SEC to Ignore Safety	Window to Ext. Safety Time(SEC)	Safety Time Ext. (SEC)
COOL ENABLE	22	18	29	0.1	1	1	1	1	Lockout	1	1	1

Above columns are active when ‘LOCKOUT’ is type of setpoint

### 22.1.3 ALARM

This type of Setpoint has two uses:

1. When it is used as a safety, it will be similar to the LOCKOUT Setpoint except it will never cause a lock out. The system will continue to try returning to normal operation after waiting the safety down time. An ALARM Setpoint type will never require manual intervention to reset the system.
2. When the Setpoint is being used as a second timer it will be available to change in a live unit. If the type is not changed to ALARM then the time field cannot be viewed or changed from a live unit.

**Sec. to ignore safety** - If this value is not zero, at compressor startup this safety will be ignored for the time in this field.

**Window to extend Safety ‘Time (sec)’** – If this value is not zero, at compressor startup the normal Safety Time will be increased by the value in Safety Time Extension field for the time specified in this field.

**Safety Time Extension (Sec)** – This is the value that will be added to the Safety Time during the Window to extend Safety Time period.

Name	Value	Min	Max	Adjust Value	Time (SEC)	Max Time Allowed (SEC)	Lockout Delay (HRS)	Safety Down Time(MIN)	Type of Setpoint	SEC to Ignore Safety	Window to Ext. Safety Time(SEC)	Safety Time Ext. (SEC)
COOL ENABLE	22	18	29	0.1	1	1	1	1	Alarm	1	1	1

Above columns are active when 'ALARM' is type of setpoint

**22.1.4 Time**

This type of Setpoint allows the 'Time (SEC)' value to be displayed and modified in a live unit.

Time A (SEC)	Max Time A Allowed (SEC)	Time B (SEC)	Max Time B Allowed (SEC)	Time C (SEC)	Max Time C Allowed (SEC)
0	0	0	0	60	0

Above columns are active when 'TIME' is type of setpoint

**22.1.5 Target**

This type of set point is used to develop a target with a high and low zone values.

The decimal characteristics of these values are the same as the Value field

**High Zone** – The value of this cell is added to the Value cell to create the high zone value.

**Low Zone** – The value of this cell is subtracted from the Value cell to create the low zone value.

**Night Setback** – If system has an unoccupied mode, this value is used to modify the value of the 'Value' cell.

Name	Zone Value	Zone MIN	Zone MAX	MAX ROC Value	MAX ROC MIN Limit	MAX ROC MAX Limit	ROC Interval Value	ROC Interval MIN Limit	ROC Interval MAX Limit	Adjust Multiplier Value	Adjust Divider Value
COOL ENABLE	0	0	0	0	0	0	1	1	1	1	1

Above columns are active when 'TARGET' is type of setpoint

**22.1.6 Delay**

This type of set point is used to develop a target with a high and low zone values.

The decimal characteristics of these values are the same as the Value field

**High Zone** – The value of this cell is added to the Value cell to create the high zone value.

**Low Zone** – The value of this cell is subtracted from the Value cell to create the low zone value.

**Night Setback** – If system has an unoccupied mode, this value is used to modify the value of the 'Value' cell.

MIN ADJ % Value	MAX ADJ % Value	MIN ADJ % Limit	MAX ADJ % Limit	MIN Capacity % Value	MAX Capacity % Value	MIN Capacity % Limit	MAX Capacity % Limit	Delay Multiplier Value	Delay Divisor Value
0.1	0.1	0.1	0.1	0.1	0.1	0.1	0.1	1	1

Above columns are active when 'DELAY' is type of setpoint

**22.1.7 Minimum Capacity**

This type will allow adjustments to the 'MIN or MAX ADJ' and 'MIN or MAX CAPACITY VALUES'. The below columns can be adjusted in MCS-CONFIG with type of setpoint.

MIN ADJ % Value	MAX ADJ % Value	MIN ADJ % Limit	MAX ADJ % Limit	MIN Capacity % Value	MAX Capacity % Value	MIN Capacity % Limit	MAX Capacity % Limit	Delay Multiplier Value
0	0	0	0	0	0	0	0	1

Above columns are active when 'MINIMUM CAPACITY is type of setpoint

### 22.1.8 Warning

A warning alert is made active with this type of setpoint. Adjustments can be made to the following columns in MCS-CONFIG.

Name	Value	Min	Max	Adjust Value	Time (SEC)	Max Time Allowed (SEC)	Lockout Delay (HRS)	Safety Down Time(MIN)	Type of Setpoint	SEC to Ignore Safety	Window to Ext. Safety Time(SEC)	Safety Time Ext. (SEC)
COOL ENABLE	22	18	29	0.1	1	1	1	1	Warning	1	1	1

Above columns are active when **'WARNING'** is type of setpoint

### 22.1.9 Enable

Additional Columns in MCS-CONFIG will be 'ENABLED' when you choose this setpoint type.

Name	Zone Value	Zone MIN	Zone MAX	MAX ROC Value	MAX ROC MIN Limit	MAX ROC MAX Limit	ROC Interval Value	ROC Interval MIN Limit	ROC Interval MAX Limit	Adjust Multiplier Value	Adjust Divider Value
COOL ENABLE	0.1	0.1	0.1	0.1	0.1	0.1	1	1	1	1	1

Above columns are active when **'ENABLE'** is type of setpoint

## 22.2. Window/Safety extension

### 22.2.1 Time and seconds to ignore for setpoints

- **Seconds to ignore** – This is the time in seconds to ignore the associated safety at compressor start up. *The window to extend safety time and safety time extension fields work together.*
- **Window to extend safety** – This value in seconds is the time window when the compressor starts that the **safety time extension** is added to the safety **time(sec)** value.
- **Safety time extension** – This value is the time that is added to the **time(sec)** value during the **window to extend safety time(sec)** time.

**Example** – Unsafe suction setpoint has a 3 second safety trip. So if we add a 120 to our window to extend safety, we will then be telling the controller at startup we're going to extend that 3 second safety trip for 120 seconds. This is where the Safety time extension comes into play. If we put a 6 in this field we're telling the controller for the first 120 seconds at startup we're extending the safety trip time to 9 seconds (3 second trip plus the 6 second extension). Once the 120 seconds expires we will then revert back to a 3 second trip time for the duration of the compressors run time till the next startup.

Setpoint Information Screen															
Name	Value	Min	Max	Adjust Value	Time (SEC)	Max Time Allowed (SEC)	Lockout Delay (HRS)	Safety Down Time(MIN)	Active or Non-Active	Select Value: # decimals & print char	Level Of Auth. To Display	Type of Setpoint	SEC to Ignore Safety	Window to Ext. Safety Time(SEC)	Safety Time Ext. (SEC)
LOW SUCT PSI	85	75	100	1	180	300	2	0	Active	PSI GAGE	Supervisor L	Lockout	30	600	120
HP SUCT OFST	20	5	50	1	---	---	---	---	Active	HUMD or %	Supervisor L	Setpoint	---	---	---
UNSAFE SUCT	45	35	65	0.5	3	10	2	5	Active	PSI GAGE	View Only	Lockout	3	120	6



# Chapter - 23. Displaying Setpoints

## 23.1. Keypad/Display

1. Press 'MENU' button
2. Press 'DOWN' button until the Setpoints screen appears
3. Press 'ENTER' button

## 23.2. MCS-CONNECT

1. Using MCS-CONNECT, connect to the MicroMag using the RS485 port
2. If multiple units select tab for this MicroMag and you will get a status display
3. In the bottom of the control section, of the status display, select Setpoints

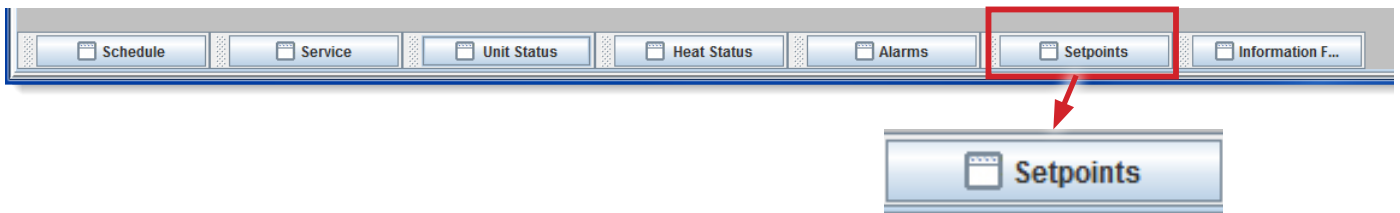

4. Only those setpoints that are set to active in your config program will be visible.

#	SetPoints	Value	Time	Zone	Max ROC	ROC Interval	Adj Mult.	Adj Div.	Min Adj	Max Adj	Min Capac.	Max Capac.	Delay Mult.	Delay Div.	SEC Ignore	Window EXT	Safety EXT	Time B	Time C	Type
1	COOL ENABLE	65.0F	----	1.0F	----	----	----	----	----	----	----	----	----	----	----	----	----	----	----	ENABLE
2	HEAT ENABLE	60.0F	----	1.0F	----	----	----	----	----	----	----	----	----	----	----	----	----	----	----	ENABLE
3	DEH ENABLE	50.0D	----	5.0D	----	----	----	----	----	----	----	----	----	----	----	----	----	----	----	ENABLE
8	COOL TARGET	75.0F	----	1.0F	0.5F	60 S	10	2	----	----	----	----	----	----	----	----	----	----	----	TARGET
9	CoolStepDely	300s	----	----	----	----	----	----	1.0 %	5.0 %	30 %	100 %	1	3	----	----	----	----	----	ADJUST
10	HEAT TARGET	70.0F	----	1.0F	3.0F	60 S	1	1	----	----	----	----	----	----	----	----	----	----	----	TARGET
17	CND TRGT PSI	330.0P	----	30.0P	6.0P	8 S	1	1	----	----	----	----	----	----	----	----	----	----	----	TARGET
18	CND STEP DLY	5s	----	----	----	----	----	----	2.0 %	20.0 %	20 %	100 %	1	50	----	----	----	----	----	ADJUST
23	DehSuctTmpTrg	45.0F	----	0.5F	0.3F	60 S	1	5	----	----	----	----	----	----	----	----	----	----	----	TARGET
34	LoAmbCompOff	55.0F	----	----	----	----	----	----	----	----	----	----	----	----	----	----	----	----	----	SETPOINT
35	HiAmbHeatOff	80.0F	----	----	----	----	----	----	----	----	----	----	----	----	----	----	----	----	----	SETPOINT
39	COMP MIN RUN	3m	----	----	----	----	----	----	----	----	----	----	----	----	----	----	----	----	----	SETPOINT
40	ACYC ON-ON	10s	----	----	----	----	----	----	----	----	----	----	----	----	----	----	----	----	----	SETPOINT
41	ACYC OFF-ON	10s	----	----	----	----	----	----	----	----	----	----	----	----	----	----	----	----	----	SETPOINT
45	SftyUnldDely	15s	----	----	----	----	----	----	----	----	----	----	----	----	----	----	----	----	----	SETPOINT
46	SftyHoldDely	180s	----	----	----	----	----	----	----	----	----	----	----	----	----	----	----	----	----	SETPOINT
47	SftyUnldAdj	25.0%	----	----	----	----	----	----	----	----	----	----	----	----	----	----	----	----	----	SETPOINT
48	CompStartup%	100....	60 S	----	----	----	----	----	----	----	----	----	----	----	10 S	60 S	10 S	----	----	ALM ONLY
50	CmpAdjustDly	25s	----	----	----	----	----	----	----	----	----	----	----	----	----	----	----	----	----	SETPOINT
51	COMPR 1 FLA	64.0A	----	----	----	----	----	----	1.0 %	5.0 %	0 %	0 %	1	5	----	----	----	----	----	ADJUST
52	COMPR 2 FLA	64.0A	----	----	----	----	----	----	1.0 %	5.0 %	0 %	0 %	1	5	----	----	----	----	----	ADJUST
55	LOW AMP %	10.0%	10 S	----	----	----	----	----	----	----	----	----	----	----	10 S	60 S	10 S	----	----	LOCKOUT
56	HIGH AMP %	110....	2 S	----	----	----	----	----	----	----	----	----	----	----	5 S	60 S	2 S	----	----	LOCKOUT
57	HiAmpUnldHld	105....	----	----	----	----	----	----	----	----	----	----	----	----	----	----	----	----	----	SETPOINT
62	LOW SUCT PSI	95.0P	120 S	----	----	----	----	----	----	----	----	----	----	----	0 S	300 S	120 S	----	----	LOCKOUT
64	UNSAFE SUCT	40.0P	3 S	----	----	----	----	----	----	----	----	----	----	----	5 S	300 S	5 S	----	----	LOCKOUT
65	LO SUCT UNLD	2.0P	5 S	----	----	----	----	----	----	----	----	----	----	----	----	----	----	0 S	0 S	TIME
66	LO SUCT RELD	5.0P	----	----	----	----	----	----	----	----	----	----	----	----	----	----	----	----	----	SETPOINT
67	LO SUCT SPHT	4.0F	300 S	----	----	----	----	----	----	----	----	----	----	----	0 S	10 S	120 S	----	----	ALM ONLY
68	HI SUCT SPHT	35.0F	300 S	----	----	----	----	----	----	----	----	----	----	----	0 S	600 S	120 S	----	----	LOCKOUT
69	LOW DISC PSI	170.0P	90 S	----	----	----	----	----	----	----	----	----	----	----	30 S	300 S	90 S	----	----	LOCKOUT
70	HI DISC PSI	600.0P	2 S	----	----	----	----	----	----	----	----	----	----	----	0 S	0 S	0 S	----	----	LOCKOUT
71	HI DISC UNLD	60.0P	----	----	----	----	----	----	----	----	----	----	----	----	----	----	----	----	----	SETPOINT
72	HI DISC RELD	100.0P	----	----	----	----	----	----	----	----	----	----	----	----	----	----	----	----	----	SETPOINT
85	HiSupplyTmp	150.0F	5 S	----	----	----	----	----	----	----	----	----	----	----	0 S	0 S	0 S	----	----	ALM ONLY
86	FREEZE TEMP	32.0F	240 S	----	----	----	----	----	----	----	----	----	----	----	0 S	0 S	0 S	----	----	ALM ONLY
100	IGN PROOF	2.0F	360 S	----	----	----	----	----	----	----	----	----	----	----	10 S	10 S	50 S	----	----	LOCKOUT
101	ModGasWarmup	60s	----	----	----	----	----	----	----	----	----	----	----	----	----	----	----	----	----	SETPOINT
106	REHEAT FLUSH	60.0%	900 S	----	----	----	----	----	----	----	----	----	----	----	----	----	----	60 S	60 S	TIME
107	GasLoFireDsb	18.0%	----	----	----	----	----	----	----	----	----	----	----	----	----	----	----	----	----	SETPOINT

### 23.3. CALCULATION MADE IN SETPOINTS IN MICROMAG FIRMWARE

Within the MCS-MicroMag system, mathematical calculations and placement of decimal points are handled internally and placed in the fields in the status window of MCS-CONNECT or MCS-KEYPAD.

Some calculations need certain numbers to show the correct value in the TARGET field and to make the correct adjustment to a controlling sensor.

This is true in the Target type of setpoints when we are looking at the Temperature.

**For example: If the setpoint is a target setpoint and the value is temperature, the calculation calls for one decimal place and the value is 'F' Fahrenheit or 'C' Celsius in the TARGET field as shown on the right.**

**IT IS IMPORTANT TO NOTE THAT WHEN ENTERING A NUMBER IN THE ADJUST MULTIPLIER FIELD TO BRING YOUR CONTROLLING SENSOR CLOSER TO THE TARGET YOU NEED TO ADD NUMBERS IN THE 10's because of the one decimal point in the 'TEMP' field.**

**EXAMPLE:** Target is 75° - Controlling Sensor is 85°. There is a 10° difference in the Target and the controlling sensor.

If you want to bring the controlling sensor to be within 5° of the target you would use the following numbers in the 'ADJUST MULTIPLIER' and 'ADJUST DIVISOR'

$$\frac{\text{Difference x Adjust Multiplier}}{\text{Adjust Divisor (/)}} \quad 10^\circ \times 10 / 2 = 5^\circ \text{ Adjustment}$$

If you are authorized, the adjustments to the controlling sensors can be made using MCS-CONNECT by opening the setpoints tab and clicking in the 'ADJ MULT. AND THE ADJ DIV. FIELDS'.

In the screen shot below, we show our Multiplier and Divisor adjusting the controlling sensor to within 5° of our TARGET as was explained above.

Type	# of Decimals	English	Metric	Mixed C/P
Spare	0			
TEMP	1	F	C	C
PSI GAGE	1	P	B	P
PSI ABS	1	p	b	p
DIGITAL/SW	0			
HUMD or %	1	%	%	%
DEWPOINT	1	D	D	D
ENTHALPY	1	h	h	h
AMPS/CT	1	A	A	A
VOLTS-0 dec	0	V	V	V
VOLTS-1 dec	1	V	V	V
VOLTS-2 dec	2	V	V	V
STATIC-2 dec	2	"	"	"
STATIC-1 dec	1	"	"	"
CYCLES/CFM	0	c	c	c
FPM	0	f	f	f
GAL/MIN	0	G	G	G
RPM'S	0	R	R	R
HOURS	0	H	H	H
MINUTES	0	m	m	m
SECONDS	0	s	s	s
DAYS	0	D	D	D
MAX STP	0	s	s	s
REF LEVEL	1	%	%	%
MTR TEMP	0	F	C	C
METER/LEAK/PP	0	p	p	p
CONDUCTIVITY	0	u	u	u
AMPS/ZERO	0	A	A	A
KW	2	kw	kw	kw
TONS	0	T	T	T
DEC1NOCH	1			
DEC2NOCH	2			

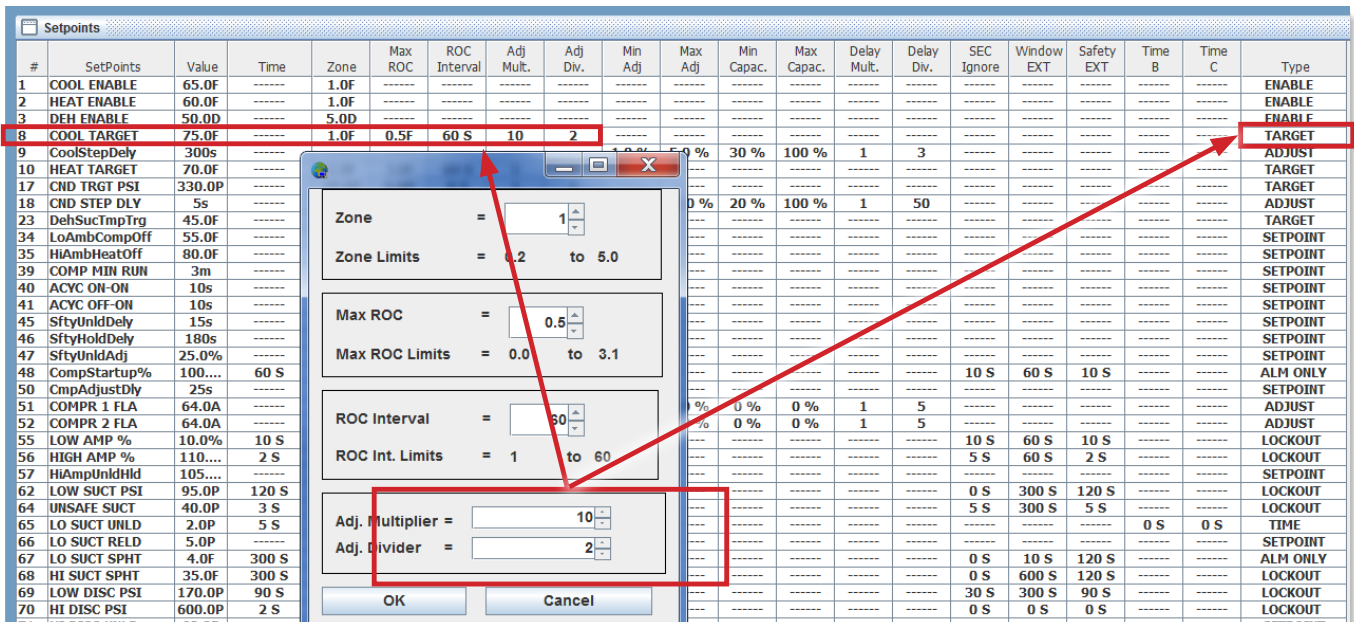

### 23.4. RTU SETPOINTS

#	Name	Type	Description
1	COOL ENABLE	ENABLE	Enable cooling mode if the controlling sensor rises above this value. When the cooling target capacity control and the mode enable utilize the same sensor, this Setpoint should be non-active. Value: Enables cooling when the control sensor rises above this value. Zone: Subtracted from the value to disable cooling.
2	HEAT ENABLE	ENABLE	Enable heating mode if the controlling sensor falls below this value. When the heating target capacity control and the mode enable utilize the same sensor, this Setpoint should be non-active. Value: Enables heating when the control sensor falls below this value. Zone: Added to the value to disable heating.
3	DEH ENABLE	ENABLE	When cooling mode and heating mode are satisfied, this Setpoint will determine if the unit should go into Dehumidification mode. Value: Controls when the MicroMag will switch into Dehumidification. Zone: Subtracted from the value to disable dehumidification.
4	DehCmpMinOvr	Minimum	If the system is in Cooling Mode and the humidity is greater than DEH ENABLE plus the value of this Setpoint, the cooling minimum capacity will be changed to the new minimum capacity value included in this Setpoint. Value: OFFSET to Setpoint #3 "DEH ENABLE" to determine whether the unit goes in Cooling minimum capacity override. MIN Capacity % Value: New cooling min capacity if cooling is in min capacity override.
5	CoolNiteStbk	SETPOINT	This is the Cooling Night Setback. This occurs when the system is in unoccupied mode. Value: The amount by which Cooling enable will be OFFSET.
6	HeatNiteStbk	SETPOINT	This is the Heating Night Setback. This occurs when the system is in unoccupied mode. Value: The amount by which the Heating enable will be OFFSET.
7	DehNiteStbk	SETPOINT	This is the Dehumidification Night Setback. This occurs when the system is in unoccupied mode. Value: The amount by which Dehumidification will be OFFSET.
8	COOL TARGET	TARGET	When in Cooling mode the system will maintain this value for the sensor selected. Value: The temperature that Cooling Capacity Control will maintain. Zone: Deadband around target temp. MAX ROC Value: The MAX Rate of Change that the capacity control will allow to determine loading or unloading. ROC Interval: The Time Interval over which the rate of change is calculated. Adjust Multiplier: The difference between the controlling sensor and the target is multiplied by this number: <b>THIS NUMBER NEEDS TO BE IN 10's.</b> Adjust Divider: This number is used to divide the product of the multiplier to scale the adjustment. <b>THIS NUMBER NEEDS TO BE IN 1's.</b>  EXAMPLE: Target is 75° Controlling Sensor is 85° and your adjust multiplier is 10 and your adjust divider is 2. 85° - 75° = 10° difference $\frac{\text{Difference} \times \text{Adjust Multiplier}}{\text{Adjust Divisor}} \quad 10 \times 1 = 10 / 2 = 5^\circ \text{Adj.}$ Scales any calculated changes to the cooling capacity.

#	Name	Type	Description
9	CoolStepDely	DELAY	<p>This Setpoint determines how quickly to adjust the cooling capacity. The farther the sensor is from target the quicker the step delay will work to reach the Setpoint.</p> <p>Value: The adjustment delay for the cooling capacity control.</p> <p>MIN Adjust % Value: Cooling capacity will not be adjusted less than this value.</p> <p>MAX Adjust % Value: Cooling capacity will not be adjusted more than this value.</p> <p>MIN Capacity % Value: Cooling capacity will not be less than this value.</p> <p>MAX Capacity % Value: Cooling capacity will not be more than this value.</p> <p>Delay multiplier/divider value: Scales any calculated changes to the cooling step delay.</p>
10	HEAT TARGET	TARGET	<p>When in Heating mode the system will maintain this value for the sensor selected.</p> <p>Value: The temperature that Heating Capacity Control will maintain.</p> <p>Zone: Will adjust the capacity control to maintain the temperature and target range for Heating.</p> <p>MAX ROC Value: The MAX Rate of Change that the capacity control will allow to determine loading or unloading.</p> <p>ROC Interval: The Time Interval that the rate of change is calculated over.</p> <p>Adjust Multiplier: The difference between the controlling sensor and the target is multiplied by this number: <b>THIS NUMBER NEEDS TO BE IN 10's.</b></p> <p>Adjust Divider: This number is used to divide the product of the multiplier to scale the adjustment. <b>THIS NUMBER NEEDS TO BE IN 1's.</b></p> <p>EXAMPLE: Target is 75° Controlling Sensor is 65° and your adjust multiplier is 10 and your adjust divider is 2. <math>65^{\circ} - 75^{\circ} = 10^{\circ}</math> difference</p> $\frac{\text{Difference} \times \text{Adjust Multiplier}}{\text{Adjust Divisor}} \quad 10 \times 1 = 10 / 2 = 5^{\circ} \text{Adj.}$ <p>Scales any calculated changes to the Heating Capacity.</p>
11	HeatStepDely	DELAY	<p>This Setpoint determines how quickly to adjust the heating capacity. The farther the sensor is from target the quicker the step delay will work to reach the Setpoint.</p> <p>Value: The adjustment delay for the heating capacity control.</p> <p>MIN Adjust % Value: Heating capacity will not be adjusted less than this value.</p> <p>MAX Adjust % Value: Heating capacity will not be adjusted more than this value.</p> <p>MIN Capacity % Value: Heating capacity will not be less than this value.</p> <p>MAX Capacity % Value: Heating capacity will not be more than this value.</p> <p>Delay multiplier/divider value: Scales any calculated changes to the heating step delay.</p>

#	Name	Type	Description
12	REHT TARGET	TARGET	<p>When in Reheating mode the system will maintain this value for the supply air temperature sensor.</p> <p>Value: The temperature the reheating capacity control will maintain.</p> <p>Zone: Will adjust the capacity control to maintain the temperature and target range for reheating.</p> <p>MAX ROC Value: The MAX rate of change that the capacity control will allow to determine loading or unloading.</p> <p>ROC Interval: The time Interval that the rate of change is calculated over.</p> <p>Adjust multiplier/divider value: Scales any calculated changes to the Reheating Capacity.</p>
13	RehtStepDely	DELAY	<p>This Setpoint determines how quickly to adjust the reheating capacity. The farther the sensor is from target the quicker the step delay will work to reach the Setpoint.</p> <p>Value: The adjustment delay for the reheating capacity control.</p> <p>MIN Adjust % Value: Reheating capacity will not be adjusted less than this value.</p> <p>MAX Adjust % Value: Reheating capacity will not be adjusted more than this value.</p> <p>MIN Capacity % Value: Reheating capacity will not be less than this value.</p> <p>MAX Capacity % Value: Reheating capacity will not be more than this value.</p> <p>Delay multiplier/divider value: Scales any calculated changes to the Reheating Step Delay.</p>
14	SplyStatcTrg	TARGET	<p>When the supply fan is needed, this Setpoint will maintain a duct static pressure.</p> <p>Value: The pressure the supply fan capacity control will maintain.</p> <p>Zone: Will adjust the capacity control to maintain the supply fan static Setpoint.</p> <p>MAX ROC Value: The MAX rate of change that the supply fan control will allow to determine increase or decrease to the supply fan speed.</p> <p>ROC Interval: The time interval the rate of change is calculated.</p> <p>Adjust multiplier/divider value: Scales any calculated changes to the Supply Static Target.</p> <p>If this Setpoint is Non-Active, the Micro-Mag will treat the Supply Fan as ON/OFF.</p>
	S-FanSpd %	SETPOINT	Value: The speed of the Supply Fan for a constant volume arrangement.
	S-FanSpd %	TARGET	<p>Controls the fan speed when the MicroMag is a single zone VAV controller and the unit is in evaporator fan only mode. This option additionally provides parameters for the single zone VAV capacity control function. Zone and target of the VAV control algorithm will be based on the cooling and heating enable Setpoints. Target of control algorithm will be halfway between the enable Setpoint and the upper bound of the zone value (lower for heating) of the appropriate enable Setpoint.</p> <p>Value: will be the speed of the supply fan when the unit is in evap fan only mode.</p> <p>MAX ROC Value: The MAX rate of change that the capacity control will allow to determine loading or unloading.</p> <p>ROC Interval: The time Interval the rate of change is calculated over.</p> <p>Adjust multiplier/divider value: Scales any calculated changes to the Supply Fan Capacity.</p>

#	Name	Type	Description
15	SplyStatcDly	DELAY	<p>This Setpoint determines how quickly to adjust the supply fan capacity. The farther the sensor is from target the quicker the step delay will work to reach the Setpoint.</p> <p>Value: The adjustment delay for the supply fan capacity control.</p> <p>MIN Adjust % Value: Supply fan capacity will not be adjusted less than this value.</p> <p>MAX Adjust % Value: Supply fan capacity will not be adjusted more than this value.</p> <p>MIN Capacity % Value: Supply fan capacity will not be less than this value.</p> <p>MAX Capacity % Value: Supply fan capacity will not be more than this value.</p> <p>Delay multiplier/divider value: Scales any calculated changes to the supply fan step delay.</p>
	S-FanSpd Dly	DELAY	<p>This Setpoint determines how quickly to adjust the supply fan capacity. The farther the sensor is from target the quicker the step delay will work to reach the Setpoint.</p> <p>Value: The adjustment delay for the supply fan capacity control.</p> <p>MIN Adjust % Value: Supply fan capacity will not be adjusted less than this value.</p> <p>MAX Adjust % Value: Supply fan capacity will not be adjusted more than this value.</p> <p>Delay multiplier/divider value: Scales any calculated changes to the supply fan step delay.</p> <p>Note: the MIN Capacity and the MAX Capacity % values are not used as they are provided in Setpoints #29 "SFanMin%Cool" &amp; #30 "SFan-Min%Heat".</p> <p>This Setpoint is used on a single zone VAV system.</p>
16	CL/HT PreDly	SETPOINT	<p>When this Setpoint is ACTIVE it will determine the minimum supply fan ON time before going into cooling or heating mode.</p>
17	CND TRGT PSI	TARGET	<p>When a compressor is running, this Setpoint is the target discharge pressure for the condenser fans.</p> <p>Value: The discharge pressure the condenser capacity control will maintain.</p> <p>Zone: Is the deadband around target psi.</p> <p>MAX ROC Value: The MAX rate of change that the capacity control will allow to determine loading or unloading of condenser fans.</p> <p>ROC Interval: The time Interval that the rate of change is calculated over.</p> <p>Adjust Multiplier: The difference between the controlling sensor and the target is multiplied by this number: <b>THIS NUMBER NEEDS TO BE IN 10's.</b></p> <p>Adjust Divider: This number is used to divide the product of the multiplier to scale the adjustment. <b>THIS NUMBER NEEDS TO BE IN 1's.</b></p> <p>Scales any calculated changes to the Reheating Capacity.</p>

#	Name	Type	Description
18	CND STEP DLY	DELAY	<p>This Setpoint determines how quickly to adjust the condenser fan capacity. The farther the sensor is from target the quicker the step delay will work to reach the Setpoint.</p> <p>Value: The adjustment for the condenser fan capacity control.</p> <p>MIN Adjust % Value: Condenser fan capacity will not be adjusted less than this value.</p> <p>MAX Adjust % Value: Condenser fan capacity will not be adjusted more than this value.</p> <p>MIN Capacity % Value: Condenser fan capacity will not be less than this value.</p> <p>MAX Capacity % Value: Condenser fan capacity will not be more than this value.</p> <p>Delay multiplier/divider value: Scales any calculated changes to the Condenser fan step delay.</p>
19	EconAmbEnabl	ENABLE	<p>This Setpoint determines the maximum temperature or enthalpy (depending on how the unit is configured) at which the economizer will be ENABLED.</p> <p>Value: Maximum Temperature or Enthalpy.</p>
20	ECON MAX %	SETPOINT	This defines the maximum opening of the economizer.
21	HiCO2MinDmpr	SETPOINT	This defines the minimum damper position when the CO2 is high (See SETPOINT #32 "HI CO2 LEVEL").
22	MIN DAMPER %	SETPOINT	If the CO2 levels are satisfied this is the minimum damper position.
23	DehSucTmpTrg	TARGET	<p>When in dehumidification mode the system will maintain this value for the target suction temperature (or saturated suction temperature if there is no suction temperature sensor) and use Setpoint #9 "CoolStepDely" as the cooling capacity delay Setpoint.</p> <p>Value: The temperature that Cooling Capacity Control will maintain.</p> <p>Zone: Will adjust the capacity control to maintain the suction temperature and target range for Cooling.</p> <p>MAX ROC Value: The MAX Rate of Change that the capacity control will allow to determine loading or unloading.</p> <p>ROC Interval: The Time Interval over which the rate of change is calculated.</p> <p>Adjust multiplier/divider value: Scales any calculated changes to the cooling capacity.</p>
24	DIRTY FILTER	ALARM	This Setpoint creates an ALARM if the clogged filter indicator is ON.
		LOCKOUT	This Setpoint will LOCKOUT the unit if this clogged filter indicator is ON.
25	EcoToMechDly	SETPOINT	<p>If ECONOMIZER is enabled this Setpoint determines how many seconds after the ECONOIMIZER is fully open before mechanical cooling is permitted to run.</p> <p>Value: Number of seconds before mechanical cooling is enabled.</p>
26	BldgStatcTrg	TARGET	<p>This Setpoint is used to maintain a building static pressure.</p> <p>Value: The pressure that building static capacity control will maintain.</p> <p>Zone: Deadband around target in which the exhaust fan will modulate to maintain.</p> <p>MAX ROC Value: The MAX rate of change that capacity control will allow to determine loading or unloading.</p> <p>ROC Interval: The time Interval the rate of change is calculated over.</p> <p>Adjust multiplier/divider value: Scales any calculated changes to the Building Static Capacity.</p>

#	Name	Type	Description
27	BldgStatcDly	DELAY	This Setpoint determines how quickly to adjust the building static capacity control. Value: The adjustment delay for the building static capacity control. MIN Adjust % Value: Building static capacity will not be adjusted less than this value. MAX Adjust % Value: Building Static capacity will not be adjusted more than this value. MIN Capacity % Value: Building Static capacity will not be less than this value. MAX Capacity % Value: Building Static capacity will not be more than this value. Delay multiplier/divider value: Scales any calculated changes to the Building Static Capacity.
28	ExhFanMinRun	SETPOINT	Minimum run time for exhaust Fan (in seconds).
29	SFanMin%Cool	DELAY	When this Setpoint is enabled the single zone VAV will be allowed for cooling. Value: The minimum supply fan speed during cooling load. MIN Capacity % Value: Minimum fan speed when high CO2 is detected. MAX Capacity % Value: Maximum fan speed when the unit is in cooling mode. NOTE: When constant air volume is desired in cooling mode the value and maximum capacity shall be set to the same value.
30	SFanMin%Heat	DELAY	When this Setpoint is enabled the single zone VAV will be allowed for heating. Value: The minimum supply fan speed during heating load. MIN Capacity % Value: Minimum fan speed when the heat pump is operating. MAX Capacity % Value: Maximum fan speed when the unit is in heating mode. NOTE: When constant air volume is desired in heating mode the value and maximum capacity shall be set to the same value.
31	HiBldgStatic	ALARM	This Setpoint creates an ALARM if high building static pressure is detected. Value: Will trigger and alarm when setpoint is reached. Time: Time in seconds the Building Static pressure is allowed above Setpoint value before the ALARM is tripped.
32	HI CO2 LEVEL	SETPOINT	This Setpoint determines a high CO2 condition has occurred. Value: High CO2 level in PPM.
33	HI CO2 ZONE	SETPOINT	This Setpoint is the dead band for the high CO2 level. When the CO2 level has dropped below the high CO2 level minus this amount, the high CO2 condition is cleared. Value: CO2 Zone in PPM.
34	LoAmbCompOff	ENABLE	If ambient temperature is below this Setpoint, the compressor will be disabled until the ambient temperature reaches the zone value degrees above the value of the Setpoint. Value: The ambient temperature the compressor will be disabled. Zone: The ambient temperature deadband.
		SETPOINT	If ambient temperature is below this Setpoint, the compressor will be disabled until the ambient temperature rises 2 degrees above the value. Value: The ambient temperature the compressor will be disabled.



#	Name	Type	Description
35	HiAmbHeatOff	ENABLE	If ambient temperature is above this Setpoint, the heating will be disabled until the ambient temperature is lower than Setpoint value minus the enable zone. Value: The ambient temperature above which heating will be disabled. Zone: Degrees below the value that ambient temperature must reach before heating will be re-enabled.
		SETPOINT	If ambient temperature is above this Setpoint, the heating will be disabled until the ambient temperature is lower than Setpoint value minus 2 degrees. Value: The ambient temperature above which heating will be disabled.
36	OVERRIDE	SETPOINT	This Setpoint will determine how long the Micro-Mag will be in override. When the override switch is depressed the unit will exit "Un-occupied" mode and enter "Override" mode. Value: The number of minutes that the Micro-Mag will be in override.
37	LEAD COMP	ALARM	Identifies the lead compressor. If set to "0" the automatic rotation will be enabled. Value: Lead compressor (If set to "0" automatic rotation will be enabled). Time: If the compressor is in automatic rotation and the value of Setpoint #38 "CompRotation" is set to greater than "0", then compressor will rotate according to run time. If set to "0" the compressors will rotate each cycle.
38	CompRotation	SETPOINT	If compressor rotation is enabled (Value of Setpoint #37 "LEAD COMP" is "0"), then this Setpoint determines the number of days for rotation. Value: The number of days that compressor will be in rotation.
39	COMP MIN RUN	SETPOINT	The minimum number of minutes the compressor must run. Value: The number of minutes the compressor must run before it is allowed to shut off.
40	ACYC ON-ON	SETPOINT	The time difference between the compressor ON cycle and when the compressor can restart. This limits the number of starts per hour. Value: The number of seconds the compressor has to wait before it can turn ON again.
41	ACYC OFF-ON	SETPOINT	The time the compressor must be OFF before restarting. Value: The number of seconds that the compressor must be OFF before it will turn ON.
42	PMP DOWN PSI	SETPOINT	If this Setpoint is active the system will PUMP DOWN, running compressors to this Setpoint before turning OFF. A PUMP DOWN is also performed at startup. Value: This is the suction pressure value for turning OFF the compressor when in the PUMP DOWN or for opening the liquid line solenoid during the PRE-PUMP DOWN state.
43	PmpDownDealy	SETPOINT	The PUMP DOWN timer limits the length of time a compressor can be in PUMP DOWN. Value: Specifies the maximum number of seconds that the compressor will remain in PUMP DOWN mode before going into anti-cycle.
		LOCKOUT	The PUMP DOWN timer limits the length of time a compressor can be in PUMP DOWN. If this time is reached, the compressor will lockout. Value: Specifies the maximum number of seconds that the compressor can remain in PUMP DOWN mode. If this time is reached, the compressor will lockout.

#	Name	Type	Description
44	SERVICE MODE	SETPOINT	If non-zero, then a compressor being disabled by the PUMP DOWN switch will continue to run until its suction pressure is zero. The compressor will be turned ON to perform the PUMP DOWN the number of times indicated in this Setpoint. This is in preparation for service to be performed on the compressor. Value: If the value is zero, then service mode is OFF. IF the value is greater than zero the active compressor will be pumped down to zero PSI this number of times before shutting OFF.
45	SftyUnldDely	SETPOINT	If a compressor is in a safety unload, the compressor will wait this amount between unload adjustments. Value: Seconds between unload adjustments.
46	SftyHoldDely	SETPOINT	This is how long the unit will stay in the safety hold state. Value: Seconds the compressor will stay in safety hold.
47	SftyUnldAdj	SETPOINT	When a compressor is unloading because of safety, this Setpoint will determine the percent of compressor capacity that will be adjusted every unload cycle. Value: The percent the compressor will be adjusted.
48	CompStartup%	SAFETY	This is the starting percent for a compressor whether it is a Digital or Frequency Drive Controlled. Value: The starting compressor speed percentage.
49	SPARE		NOT USED.
50	CmpAdjustDly	SETPOINT	The number of seconds between compressor adjustments. Value: The delay in seconds between compressors adjustments.
51	COMP 1 FLA	SETPOINT	This Setpoint is a reference of the Full Load AMPS for Compressor 1. This value is used to calculate the high and the low amperage safety limits. Value: Full Load AMPS of Compressor 1.
52	COMP 2 FLA	SETPOINT	This Setpoint is a reference of the Full Load AMPS for Compressor 2. This value is used to calculate the high and the low amperage safety limits. Value: Full Load AMPS of Compressor 2.
53	COMP 3 FLA	SETPOINT	This Setpoint is a reference of the Full Load AMPS for Compressor 3. This value is used to calculate the high and the low amperage safety limits. Value: Full Load AMPS of Compressor 3.
54	COMP 4 FLA	SETPOINT	This Setpoint is a reference of the Full Load AMPS for Compressor 4. This value is used to calculate the high and the low amperage safety limits. Value: Full Load AMPS of Compressor 4.

#	Name	Type	Description
55	LOW AMP %	ALARM	<p>This alarm uses the FLA of the compressor to determine what percent the Low Amp alarm is posted. At startup if the motor amperage of the compressor does not achieve this percent, the compressor is shut down and a 'LOW AMPS' Alarm is posted.</p> <p>Value: The value is the LOW AMP percentage for compressors.</p> <p>Time: The number of seconds before the Alarm is tripped.</p> <p>Lockout Delay: The compressor will Lockout if this Alarm occurs more than once within this many hours.</p> <p>Safety Down Time: The amount of time that the compressor will remain in safety when the LOW AMPS Alarm is posted.</p> <p>SEC to ignore Safety: Will ignore safety for this number of seconds.</p> <p>Window to EXT. Safety Time (SEC): At startup, for the first window to extend Safety Time seconds, allow the Safety Time to be extended.</p> <p>Safety Time Extension (SEC): If Safety Time extension is allowed, extend the Trip Delay by this many seconds.</p>
		LOCKOUT	<p>This alarm uses the FLA of the compressor to determine at what percent the Low Amp alarm is posted. At startup if the motor amps of the compressor do not achieve this percent the compressor will LOCKOUT and a 'LOW AMPS' Alarm is posted.</p> <p>Value: The value is the LOW AMP setting for the compressors.</p> <p>Time: The number of second(s) before the Alarm is tripped and the compressor shall LOCKOUT.</p> <p>SEC to Ignore Safety: Will ignore safety for this number of seconds.</p> <p>Window to EXT. Safety Time (SEC): At startup, for the first window to extend Safety Time seconds, allow the Safety Time to be extended.</p> <p>Safety Time Extension (SEC): If Safety Time extension is allowed, extend the Trip Delay by this many seconds.</p>
56	HIGH AMP %	ALARM	<p>This alarm uses FLA of the compressor to determine at what percent the High Amperage alarm is posted. If the motor amps of the compressor rises above this Setpoint, the compressor is shut down and a 'HIGH AMPS' Alarm is posted.</p> <p>Value: The value is the HIGH AMP % setting for compressors.</p> <p>Time: The number of second(s) before the Alarm is tripped.</p> <p>Lockout Delay: The compressor shall Lockout if this Alarm occurs more than once in this many hours.</p> <p>Safety Down Time: The amount of time that the compressor will remain in safety when the HIGH AMPS Alarm is posted.</p> <p>SEC to ignore Safety: Will ignore safety for this number of seconds.</p> <p>Window to EXT. Safety Time (SEC): At startup, for the first window to extend Safety Time seconds, allow the Safety Time to be extended.</p> <p>Safety Time Extension (SEC): If Safety Time extension is allowed at start up, extend the Trip Delay by this many seconds.</p>
		LOCKOUT	<p>This alarm uses FLA of the compressor to determine at what percent the High Amperage alarm is posted. If the motor amps of the compressor rise above this Setpoint, the compressor shall LOCKOUT and a 'HIGH AMPS' Alarm is posted.</p> <p>Value: The value is the HIGH AMP % setting for the compressors.</p> <p>Time: The number of second(s) before the Alarm is tripped and the compressor will LOCKOUT.</p> <p>SEC to Ignore Safety: Will ignore safety for this number of seconds.</p> <p>Window to EXT. Safety Time (SEC): At startup, for the first window to extend Safety Time seconds, allow the Safety Time to be extended.</p> <p>Safety Time Extension (SEC): If Safety Time extension is allowed at start up, extend the Trip Delay by this many seconds.</p>

#	Name	Type	Description
57	HiAmpUnldHld	SETPOINT	This Setpoint determines whether a compressor will go into High Amp Hold or Unload due to High Motor Amps. If the motor Amps are above this Setpoint, the compressor will go into High Amp Unloading. Once the current reduces below this Setpoint, the compressor will go into High Amp Hold until the load is below 100%. Value: Load percentage to determine High Amp Unload.
58	NoCompProof	ALARM	This Setpoint will shut down a compressor and post a Compressor Proof Alarm if the Compressor Proof SI is not true. Time: The number of seconds before the Alarm is sent. Lockout Delay: The compressor will Lockout if this Alarm occurs more than once in this many hours. Safety Down Time: The compressor will be in safety for this amount of minutes when the NO CMP PRF Alarm is posted. SEC to Ignore Safety: Will ignore safety for this number of seconds. Window to Ext. Safety Time (SEC): At startup, for the first window to extend Safety Time seconds, allow the Safety Time to be extended. Safety Time Extension (SEC): If Safety Time extension is allowed, extend the Trip Delay by this many seconds.
		LOCKOUT	This Setpoint will LOCKOUT a compressor and post a Compressor Proof Alarm, if the Compressor Proof SI is not true. Time: The number of second before the Alarm is tripped and the compressor will LOCKOUT. SEC to Ignore Safety: Will ignore safety for this number of seconds. Window to EXT. Safety Time (SEC): At startup, for the first window to extend Safety Time seconds, allow the Safety Time to be extended. Safety Time Extension (SEC): If Safety Time extension is allowed, extend the Trip Delay by this many seconds.
59	HI MOTOR TMP	SETPOINT	Currently NOT USED.
60	COMP FAULT	ALARM	This Setpoint will shut down a compressor and post a Compressor Fault Alarm, if the Compressor Fault SI is true. Time: The number of seconds before the Alarm is tripped. Lockout Delay: The compressor shall Lockout if this Alarm occurs more than once in this many hours. Safety Down Time: The compressor will be in safety for this amount of minutes when the CMP FAULT Alarm is posted. SEC to Ignore Safety: Will ignore safety for this number of seconds.  Window to EXT. Safety Time (SEC): At startup, for the first window to extend Safety Time seconds, allow the Safety Time to be extended. Safety Time Extension (SEC): If Safety Time extension is allowed, extend the Trip Delay by this many seconds.
		LOCKOUT	This Setpoint will LOCKOUT a compressor and post a Compressor Fault Alarm if the Compressor Fault SI is true. Time: The number of second(s) before the Alarm is tripped and the compressor will LOCKOUT. SEC to Ignore Safety: Will ignore safety for this number of seconds. Window to EXT. Safety Time (SEC): At startup, for the first window to extend Safety Time seconds, allow the Safety Time to be extended. Safety Time Extension (SEC): If Safety Time extension is allowed, extend the Trip Delay by this many seconds.

#	Name	Type	Description
61	COND FAULT	ALARM	This Setpoint will post a COND FAULT Alarm, if the Condenser Fault SI has been tripped for certain amount of time. Value: The number of seconds the Condenser Fault must be tripped before posting a COND FAULT Alarm.
		LOCKOUT	This Setpoint will post a COND FAULT Alarm and LOCKOUT the condensers, if the Condenser Fault SI has been tripped for certain amount of time. Value: The number of seconds the Condenser Fault must be tripped before posting a COND FAULT Alarm setting LOCKOUT of the condensers.
62	LOW SUCT PSI	ALARM	This Alarm uses the Suction Pressure sensor to determine whether a compressor has low suction pressure. If the compressor has low suction pressure, it will be put in Safety and a LO SUC PSI Alarm will be posted. Value: The value is the Low Suction Pressure setting for the Compressors. Time: The number of second(s) before the Alarm is posted. Lockout Delay: The compressor will Lockout if this Alarm occurs more than once in this many hours. Safety Down Time: The amount of time that the compressor will remain in safety when the alarm is posted. SEC to Ignore Safety: Will ignore safety for this number of seconds. Window to EXT. Safety Time (SEC): At startup, for the first window to extend Safety Time seconds, allow the Safety Time to be extended. Safety Time Extension (SEC): If Safety Time extension is allowed during startup, extend the Trip Delay by this many seconds.
		LOCKOUT	This Alarm uses the Suction Pressure sensor to determine whether a compressor has low suction pressure. If the compressor has low suction pressure, it will LOCKOUT and a LO SUC PSI Alarm will be posted. Value: The value is the Low Suction Pressure setting for the Compressors. Time: The number of second(s) before the Alarm is posted and the compressor will LOCKOUT. SEC to Ignore Safety: Will ignore safety for this number of seconds. Window to EXT. Safety Time (SEC): At startup, for the first window to extend Safety Time seconds, allow the Safety Time to be extended. Safety Time Extension (SEC): If Safety Time extension is allowed at startup, extend the Trip Delay by this many seconds.
63	HP SUCT OFST	SETPOINT	When in heat pump enable and this Setpoint is enabled, the low suction pressure Setpoint is reduced by this value. Value: Suction pressure to reduce Setpoint #62 "LOW SUCT PSI" by.
64	UNSAFE SUCT	LOCKOUT	This Alarm uses the Suction Pressure sensor to determine whether a compressor has unsafe suction pressure. If the compressor has unsafe suction pressure, it will LOCKOUT and UNSAFE SUC Alarm will be posted. Value: The value is the Unsafe Suction Pressure setting for the Compressors. Time: The number of second(s) before the Alarm is tripped and the compressor will LOCKOUT. SEC to Ignore Safety: Will ignore safety for this number of seconds. Window to EXT. Safety Time (SEC): At startup, for the first window to extend Safety Time seconds, allow the Safety Time to be extended. Safety Time Extension (SEC): If Safety Time extension is allowed at startup, extend the Trip Delay by this many seconds.

#	Name	Type	Description
65	LO SUCT UNLD	ALARM	This Setpoint will unload compressors with variable capacity to prevent a low suction safety. Value: The PSI above Setpoint #62 "LOW SUCT PSI" in which unloading will be active. Tripped Delay: The number of seconds the compressor will wait before unloading.
66	LO SUCT RELD	SETPOINT	If the system has had a low suction unload, after the safety period, it will reload if the suction pressure has gone above the reload Setpoint. Value: The number of PSI above Setpoint #62 "LOW SUCT PSI" that reload will be active, if unload was active.
67	LO SUCT SPHT	ALARM	This Alarm uses the suction superheat calculation to determine whether a compressor has low suction superheat. If the compressor has low suction superheat, it will be put in Safety and a LO SUC SPHT Alarm will be posted. Value: The value is the Low Suction Superheat setting for the Compressors. Time: The number of second(s) before the Alarm is posted. Lockout Delay: The compressor will Lockout if this Alarm occurs more than once in this many hours. Safety Down Time: The amount of time the compressor will remain in safety when the alarm is posted. SEC to Ignore Safety: Will ignore safety for this number of seconds. Window to EXT. Safety Time (SEC): At startup, for the first window to extend Safety Time seconds, allow the Safety Time to be extended. Safety Time Extension (SEC): If Safety Time extension is allowed during startup, extend the Trip Delay by this many seconds.
		LOCKOUT	This Alarm uses the suction superheat calculation to determine whether a compressor has low suction superheat. If the compressor has low suction superheat, it will LOCKOUT and LO SUC SHT Alarm will be posted. Value: The value is the low suction superheat setting for the Compressors. Time: The number of second(s) before the Alarm is tripped and the compressor will LOCKOUT. SEC to Ignore Safety: Will ignore safety for this number of seconds. Window to EXT. Safety Time (SEC): At startup, for the first window to extend Safety Time seconds, allow the Safety Time to be extended. Safety Time Extension (SEC): If Safety Time extension is allowed at startup, extend the Trip Delay by this many seconds.

#	Name	Type	Description
68	HI SUCT SPHT	ALARM	<p>This Alarm uses the suction superheat calculation to determine whether a compressor has high suction superheat. If the compressor has high suction superheat, it will be put in Safety and a HI SUC SPHT Alarm will be posted.</p> <p>Value: The value is the high suction superheat setting for the Compressors.</p> <p>Time: The number of second(s) before the Alarm is posted.</p> <p>Lockout Delay: The compressor will Lockout if this Alarm occurs more than once in this many hours.</p> <p>Safety Down Time: The amount of time the compressor will remain in safety when the alarm is posted.</p> <p>SEC to Ignore Safety: Will ignore safety for this number of seconds.</p> <p>Window to EXT. Safety Time (SEC): At startup, for the first window to extend Safety Time seconds, allow the Safety Time to be extended.</p> <p>Safety Time Extension (SEC): If Safety Time extension is allowed during startup, extend the Trip Delay by this many seconds.</p>
		LOCKOUT	<p>This Alarm uses the suction superheat calculation to determine whether a compressor has high suction superheat. If the compressor has low suction superheat, it will LOCKOUT and HI SUC SHT Alarm will be posted.</p> <p>Value: The value is the high suction superheat setting for the Compressors.</p> <p>Time: The number of second(s) before the Alarm is tripped and the compressor will LOCKOUT.</p> <p>SEC to Ignore Safety: Will ignore safety for this number of seconds.</p> <p>Window to EXT. Safety Time (SEC): At startup, for the first window to extend Safety Time seconds, allow the Safety Time to be extended.</p> <p>Safety Time Extension (SEC): If Safety Time extension is allowed at startup, extend the Trip Delay by this many seconds.</p>

#	Name	Type	Description
69	LOW DISC PSI	ALARM	<p>This Alarm uses the discharge pressure sensor to determine whether a compressor has low discharge pressure. If the compressor has low discharge pressure, it will be put in Safety and a LO DIS PSI Alarm will be posted.</p> <p>Value: The value is the low discharge pressure setting for the Compressors.</p> <p>Time: The number of second(s) before the Alarm is posted.</p> <p>Lockout Delay: The compressor will Lockout if this Alarm occurs more than once in this many hours.</p> <p>Safety Down Time: The amount of time that the compressor will remain in safety when the alarm is posted.</p> <p>SEC to Ignore Safety: Will ignore safety for this number of seconds.</p> <p>Window to EXT. Safety Time (SEC): At startup, for the first window to extend Safety Time seconds, allow the Safety Time to be extended.</p> <p>Safety Time Extension (SEC): If Safety Time extension is allowed during startup, extend the Trip Delay by this many seconds.</p>
		LOCKOUT	<p>This Alarm uses the discharge pressure sensor to determine whether a compressor has low discharge pressure. If the compressor has low discharge pressure, it will LOCKOUT and a LO DIS PSI Alarm will be posted.</p> <p>Value: The value is the Low discharge Pressure setting for the Compressors.</p> <p>Time: The number of second(s) before the Alarm is posted and the compressor will LOCKOUT.</p> <p>SEC to Ignore Safety: Will ignore safety for this number of seconds.</p> <p>Window to EXT. Safety Time (SEC): At startup, for the first window to extend Safety Time seconds, allow the Safety Time to be extended.</p> <p>Safety Time Extension (SEC): If Safety Time extension is allowed at startup, extend the Trip Delay by this many seconds.</p>



#	Name	Type	Description
70	HI DISC PSI	ALARM	<p>This Alarm uses the discharge pressure sensor to determine whether a compressor has high discharge pressure. If the compressor has high discharge pressure, it will be put in Safety and a HI DIS PSI Alarm will be posted.</p> <p>Value: The value is the high discharge pressure setting for the Compressors.</p> <p>Time: The number of second(s) before the Alarm is posted.</p> <p>Lockout Delay: The compressor will Lockout if this Alarm occurs more than once in this many hours.</p> <p>Safety Down Time: The amount of time that the compressor will remain in safety when the alarm is posted.</p> <p>SEC to Ignore Safety: Will ignore safety for this number of seconds.</p> <p>Window to EXT. Safety Time (SEC): At startup, for the first window to extend Safety Time seconds, allow the Safety Time to be extended.</p> <p>Safety Time Extension (SEC): If Safety Time extension is allowed during startup, extend the Trip Delay by this many seconds.</p>
		LOCKOUT	<p>This Alarm uses the discharge pressure sensor to determine whether a compressor has high discharge pressure. If the compressor has high discharge pressure, it will LOCKOUT and a HI DIS PSI Alarm will be posted.</p> <p>Value: The value is the high discharge pressure setting for the Compressors.</p> <p>Time: The number of second(s) before the Alarm is posted and the compressor will LOCKOUT.</p> <p>SEC to Ignore Safety: Will ignore safety for this number of seconds.</p> <p>Window to EXT. Safety Time (SEC): At startup, for the first window to extend Safety Time seconds, allow the Safety Time to be extended.</p> <p>Safety Time Extension (SEC): If Safety Time extension is allowed at startup, extend the Trip Delay by this many seconds.</p>
71	HI DISC UNLD	ALARM	<p>This Setpoint will unload compressors with variable capacity to prevent a high discharge pressure safety.</p> <p>Value: The PSI below Setpoint #70 "HI DISC PSI" in which unloading will be active.</p> <p>Tripped Delay: The number of seconds the compressor will wait before unloading.</p>
72	HI DISC RELD	SETPOINT	<p>If the system has had a high discharge pressure unload, after the safety period, it will reload if the discharge pressure has gone below the reload Setpoint.</p> <p>Value: The number of PSI below Setpoint #70 "HI DISC PSI" that reload will be active, if unload was active.</p>

#	Name	Type	Description
73	HI DISC TEMP	ALARM	<p>This Alarm uses the discharge temperature sensor to determine whether a compressor has high discharge temperature. If the compressor has high discharge temperature, it will be put in Safety and a HI DIS TEMP Alarm will be posted.</p> <p>Value: The value is the high discharge temperature setting for the Compressors.</p> <p>Time: The number of second(s) before the Alarm is posted.</p> <p>Lockout Delay: The compressor will Lockout if this Alarm occurs more than once in this many hours.</p> <p>Safety Down Time: The amount of time that the compressor will remain in safety when the alarm is posted.</p> <p>SEC to Ignore Safety: Will ignore safety for this number of seconds.</p> <p>Window to EXT. Safety Time (SEC): At startup, for the first window to extend Safety Time seconds, allow the Safety Time to be extended.</p> <p>Safety Time Extension (SEC): If Safety Time extension is allowed during startup, extend the Trip Delay by this many seconds.</p>
		LOCKOUT	<p>This Alarm uses the discharge temperature sensor to determine whether a compressor has high discharge temperature. If the compressor has high discharge temperature, it will LOCKOUT and a HI DIS TEMP Alarm will be posted.</p> <p>Value: The value is the high discharge temperature setting for the Compressors.</p> <p>Time: The number of second(s) before the Alarm is posted and the compressor will LOCKOUT.</p> <p>SEC to Ignore Safety: Will ignore safety for this number of seconds.</p> <p>Window to EXT. Safety Time (SEC): At startup, for the first window to extend Safety Time seconds, allow the Safety Time to be extended.</p> <p>Safety Time Extension (SEC): If Safety Time extension is allowed at startup, extend the Trip Delay by this many seconds.</p>
74	DiscTmpUnld	ALARM	<p>This Setpoint will unload compressors with variable capacity to prevent a high discharge temperature safety.</p> <p>Value: The temperature below Setpoint #70 "HI DISC TEMP" in which unloading will be active.</p> <p>Tripped Delay: The number of seconds the compressor will wait before unloading.</p>
75	DiscTmpReId	SETPOINT	<p>If the system has had a high discharge pressure temperature unload, after the safety period, it will reload if the discharge temperature has gone below the reload Setpoint.</p> <p>Value: The number of degrees below Setpoint #73 "HI DISC TEMP" that reload will be active, if unload was active.</p>

#	Name	Type	Description
76	LO DISC SPHT	ALARM	<p>This alarm uses the discharge superheat calculation to determine when a compressor has low discharge superheat. If the compressor has low discharge superheat, it will be put in Safety and a LO DIS SHT Alarm will be posted.</p> <p>Value: The value is the Low Discharge Superheat setting for the Compressors.</p> <p>Time: The number of second(s) before the Alarm is posted.</p> <p>Lockout Delay: The compressor will Lockout if this Alarm occurs more than once in this many hours.</p> <p>Safety Down Time: The amount of time the compressor will remain in safety when the alarm is posted.</p> <p>SEC to Ignore Safety: Will ignore safety for this number of seconds.</p> <p>Window to EXT. Safety Time (SEC): At startup, for the first window to extend Safety Time seconds, allow the Safety Time to be extended.</p> <p>Safety Time Extension (SEC): If Safety Time extension is allowed during startup, extend the Trip Delay by this many seconds.</p>
		LOCKOUT	<p>This Alarm uses the discharge superheat calculation to determine whether a compressor has low discharge superheat. If the compressor has low discharge superheat, it will LOCKOUT and LO DIS SHT Alarm will be posted.</p> <p>Value: The value is the low discharge superheat setting for the Compressors.</p> <p>Time: The number of second(s) before the Alarm is tripped and the compressor will LOCKOUT.</p> <p>SEC to Ignore Safety: Will ignore safety for this number of seconds.</p> <p>Window to EXT. Safety Time (SEC): At startup, for the first window to extend Safety Time seconds, allow the Safety Time to be extended.</p> <p>Safety Time Extension (SEC): If Safety Time extension is allowed at startup, extend the Trip Delay by this many seconds.</p>
77	DisSprhtUnld	SETPOINT	<p>This Setpoint will unload compressors with variable capacity to prevent a low superheat safety.</p> <p>Value: The discharge superheat setting for the Compressors.</p> <p>Tripped Delay: The number of seconds the compressor will wait before unloading.</p>
78	DisSprhtReld	SETPOINT	<p>If the system has experienced a discharge superheat unload, after the safety period, it will reload if the discharge superheat has gone above the reload Setpoint.</p> <p>Value: The discharge superheat setting for the compressors to reload.</p>
79	LOW DIFF PSI	ALARM	<p>This Alarm uses the differential pressure between the suction and the oil pressure to determine whether a compressor has low differential pressure. If the compressor has low differential pressure, it will be put in Safety and a LO DIF PSI Alarm will be posted.</p> <p>Value: The value is the low differential pressure setting for the Compressors.</p> <p>Time: The number of second(s) before the Alarm is posted.</p> <p>Lockout Delay: The compressor will Lockout if this Alarm occurs more than once in this many hours.</p> <p>Safety Down Time: The amount of time the compressor will remain in safety when the alarm is posted.</p> <p>SEC to Ignore Safety: Will ignore the safety for this number of seconds.</p> <p>Window to EXT. Safety Time (SEC): At startup, for the first window to extend Safety Time seconds, allow the Safety Time to be extended.</p> <p>Safety Time Extension (SEC): If Safety Time extension is allowed during startup, extend the Trip Delay by this many seconds.</p>

#	Name	Type	Description
80	UnsafeDifPSI	LOCKOUT	<p>This Alarm uses the differential pressure between the suction and the discharge to determine whether a compressor has low differential pressure. If the compressor has low differential pressure, it will LOCKOUT and a LO DIF PSI Alarm will be posted.</p> <p>Value: The value is the unsafe differential pressure setting for the Compressors.</p> <p>Time: The number of second(s) before the Alarm is posted and the compressor will LOCKOUT.</p> <p>SEC to Ignore Safety: Will ignore safety for this number of seconds.</p> <p>Window to EXT. Safety Time (SEC): At startup, for the first window to extend Safety Time seconds, allow the Safety Time to be extended.</p> <p>Safety Time Extension (SEC): If Safety Time extension is allowed at startup, extend the Trip Delay by this many seconds.</p>
81	HI PSI SW	ALARM	<p>This Setpoint will shut down a compressor and post a HI PSI SW Alarm, if the Compressor High SI Off input is true.</p> <p>Time: The number of seconds before the Alarm is tripped.</p> <p>Lockout Delay: The compressor shall Lockout if this Alarm occurs more than once in this many hours.</p> <p>Safety Down Time: The compressor will be in safety for this amount of minutes when the HI PSI SW Alarm is posted.</p> <p>SEC to Ignore Safety: Will ignore safety for this number of seconds.</p> <p>Window to EXT. Safety Time (SEC): At startup, for the first window to extend Safety Time seconds, allow the Safety Time to be extended.</p> <p>Safety Time Extension (SEC): If Safety Time extension is allowed, extend the Trip Delay by this many seconds.</p>
		LOCKOUT	<p>This Setpoint will LOCKOUT a compressor and post a HI PSI SW if the High SI Off Fault SI is true.</p> <p>Time: The number of second(s) before the Alarm is tripped and the compressor will LOCKOUT.</p> <p>SEC to Ignore Safety: Will ignore safety for this number of seconds.</p> <p>Window to EXT. Safety Time (SEC): At startup, for the first window to extend Safety Time seconds, allow the Safety Time to be extended.</p> <p>Safety Time Extension (SEC): If Safety Time extension is allowed, extend the Trip Delay by this many seconds.</p>

#	Name	Type	Description
82	LO PSI SW	ALARM	<p>This Setpoint will shut down a compressor and post a LO PSI SW Alarm, if the Compressor Low SI Off input is true.</p> <p>Time: The number of seconds before the Alarm is tripped.</p> <p>Lockout Delay: The compressor shall Lockout if this Alarm occurs more than once in this many hours.</p> <p>Safety Down Time: The compressor will be in safety for this amount of minutes when the LO PSI SW Alarm is posted.</p> <p>SEC to Ignore Safety: Will ignore safety for this number of seconds.</p> <p>Window to EXT. Safety Time (SEC): At startup, for the first window to extend Safety Time seconds, allow the Safety Time to be extended.</p> <p>Safety Time Extension (SEC): If Safety Time extension is allowed, extend the Trip Delay by this many seconds.</p>
		LOCKOUT	<p>This Setpoint will LOCKOUT a compressor and post a LO PSI SW if the "Low SI Off" Fault SI is true.</p> <p>Time: The number of second(s) before the Alarm is tripped and the compressor will LOCKOUT.</p> <p>SEC to Ignore Safety: Will ignore safety for this number of seconds.</p> <p>Window to EXT. Safety Time (SEC): At startup, for the first window to extend Safety Time seconds, allow the Safety Time to be extended.</p> <p>Safety Time Extension (SEC): If Safety Time extension is allowed, extend the Trip Delay by this many seconds.</p>
83	PhasLossRset	ALARM	<p>This alarm will Temporarily shut down the entire unit when a phase loss has occurred.</p> <p>Value: the number of seconds after the input is energized before the unit will be disabled.</p> <p>Safety Down Time: The number of minutes the phase loss must be off before the unit is reactivated.</p>
		LOCKOUT/ SETPOINT	<p>This lockout/Setpoint will shut down the entire unit when a phase loss has occurred.</p> <p>Value: the number of seconds after the input is energized before the unit will be locked out.</p> <p>Note: If this value is inactive then the Setpoint will be 2 seconds.</p>
84	HEAT FAULT	ALARM	<p>This Setpoint will shut down the heating mode and post a HEAT FAULT Alarm if the heater fault SI is true.</p> <p>Time: The number of seconds before the Alarm is sent.</p> <p>Lockout Delay: The compressor will Lockout if this Alarm occurs more than once in this many hours.</p> <p>Safety Down Time: The heating mode will be in safety for this amount of minutes when the HEAT FAULT Alarm is posted.</p> <p>SEC to Ignore Safety: Will ignore safety for this number of seconds.</p> <p>Window to Ext. Safety Time (SEC): At startup, for the first window to extend Safety Time seconds, allow the Safety Time to be extended.</p> <p>Safety Time Extension (SEC): If Safety Time extension is allowed, extend the Trip Delay by this many seconds.</p>
		LOCKOUT	<p>Time: The number of seconds before the Alarm is sent.</p> <p>Lockout Delay: The compressor will Lockout if this Alarm occurs more than once in this many hours.</p> <p>Safety Down Time: The heating mode will be in safety for this amount of minutes when the HEAT FAULT Alarm is posted.</p> <p>SEC to Ignore Safety: Will ignore safety for this number of seconds.</p> <p>Window to Ext. Safety Time (SEC): At startup, for the first window to extend Safety Time seconds, allow the Safety Time to be extended.</p> <p>Safety Time Extension (SEC): If Safety Time extension is allowed, extend the Trip Delay by this many seconds.</p>

#	Name	Type	Description
85	HiSupplyTmp	ALARM	This alarm will temporarily disable the heating when the supply temperature sensor reaches Setpoint. Value: The value is the high supply temperature setting for the heating. Time: The number of second(s) before the Alarm is posted. Safety Down Time: The amount of time that the heating will remain in safety when the alarm is posted. Window to EXT. Safety Time (SEC): At startup, for the first window to extend Safety Time seconds, allow the Safety Time to be extended. Safety Time Extension (SEC): If Safety Time extension is allowed during startup, extend the Trip Delay by this many seconds.
		LOCKOUT	This alarm will disable the heating when the supply temperature sensor reaches Setpoint. Value: The value is the high supply temperature setting for the heating. Time: The number of second(s) before the Alarm is posted. Safety Down Time: The amount of time that the heating will remain in safety when the alarm is posted. SEC to Ignore Safety: Will ignore safety for this number of seconds. Window to EXT. Safety Time (SEC): At startup, for the first window to extend Safety Time seconds, allow the Safety Time to be extended. Safety Time Extension (SEC): If Safety Time extension is allowed during startup, extend the Trip Delay by this many seconds.
86	FREEZE TEMP	ALARM	If the supply air temperature goes below this value for the FREEZE TEMP's time then the alarm is posted. Value: The value is the supply air temperature to cause the alarm Lockout Delay: The compressor shall Lockout if this Alarm occurs more than once in this many hours. Safety Down Time: The amount of time that the heating will remain in safety when the alarm is posted. Window to EXT. Safety Time (SEC): At startup, for the first window to extend Safety Time seconds, allow the Safety Time to be extended. Safety Time Extension (SEC): If Safety Time extension is allowed during startup, extend the Trip Delay by this many seconds.
		LOCKOUT	Value: The value is the supply air temperature to cause the lockout Time: The number of second(s) before the Alarm is posted. Safety Down Time: The amount of time that the heating will remain in safety when the alarm is posted. SEC to Ignore Safety: Will ignore safety for this number of seconds. Window to EXT. Safety Time (SEC): At startup, for the first window to extend Safety Time seconds, allow the Safety Time to be extended. Safety Time Extension (SEC): If Safety Time extension is allowed during startup, extend the Trip Delay by this many seconds.
87	SPARE STPT		For Future use
88	DIFF TEMP		This Setpoint is currently not used.
89	CFG TEST = 0	SETPOINT	If this value is "0" this Setpoint prevents lockout of the controller when communication is lost. This is primarily used for testing purposes.
90	HPLowAmbDsbl	TARGET	This Setpoint will prevent the compressor from running in heat pump when the ambient temperature is below this Setpoint's value. Value: the ambient temperature.
91	RevValveDely	SETPOINT	This Setpoint will delay the rev valve when there is a call for heat pump. It also delays the rev valve when it goes from heat pump to cooling. Value: The number in seconds the compressor is delayed.

#	Name	Type	Description
92	HPAmbDsbIDef	SETPOINT	This Setpoint will prevent the system from going into defrost when the ambient is above the setting. Value: The ambient temperature settings to disable defrost.
93	DEF TERM TMP	SETPOINT	This Setpoint will terminate the defrost cycle when the input reaches this setting during a defrost. Value: the temperature where the defrost is terminated.
94	MaxDefRunTim	SETPOINT	Once a defrost is enabled this Setpoint limits the amount of time the system will remain in defrost. Value: the maximum number of minutes the system can remain in the defrost cycle.
95	WtdDefDur %	SETPOINT	This Setpoint is the target defrost time based on the percentage of the Maximum Defrost Run Time. Value: the percentage of the MaxDefRunTime that the system will work to remain in defrost.
96	BtweenDefAdj	SETPOINT	This Setpoint adjusts the delay between defrosts based on whether the system terminated early on temperature or later on time. Value: duration of seconds to adjust the time between defrosts. Is added to thr setpoint 97 dly between defrost. If we don't reach 90% and come out of defrost before, and if we go all the way to 100% and come out of defrost before, and if we go all the way to 100% than subtract.
97	DelayBtwnDef	SETPOINT	Upon startup, this Setpoint is the initial time in minutes between defrost cycles.
98	HPCndTrgOfst	TARGET	When in heat pump enabled, this target modifies the condenser fan cycling (outdoor coil) target pressure. Value: the pressure to offset Setpoint #17 "Condenser Target PSI" when the unit is in heat pump mode and the reversing valve is on. Zone: the pressure to offset Setpoint #17 "Condenser Target PSI" by when the unit is defrosting.
99	MaxTrgtReset	TARGET	This Setpoint limits the target reset allowed by the BMS. Value: the max/min cooling target reset allowed. Zone: the max/min heating target reset allowed. Max ROC: the max/min dehumidification target reset percentage allowed.

#	Name	Type	Description
100	IGN PROOF	WARNING	This Setpoint looks for a proof of ignition through an increase in temperature of the ignition indicator SI to confirm the heating section is operational. If ignition has not been confirmed an "IGNITION FLT" alarm will be displayed. Value: the rise in supply temperature needed to confirm ignition has taken place. Time: Duration of time that we look at ignition temperature increase.
		ALARM	This Setpoint looks for a proof of ignition through an increase in temperature of the ignition indicator SI to confirm the heating section is operational. If ignition has not been confirmed an "IGNITION FLT" alarm will be displayed and it puts the gas valve in safety. Value: the rise in supply temperature needed to confirm ignition has taken place. Time: Duration of time required to pass before the controller will look at the ignition temperature increase. Safety Down Time: the amount in minutes the ignition valve will be put into safety. Lockout Delay: The ignition valve will Lockout if this Alarm occurs more than once in this many hours.
		LOCKOUT	This Setpoint looks for a proof of ignition through an increase in temperature of the ignition indicator SI to confirm the heating section is operational. If ignition has not been confirmed an "IGNITION FLT" alarm will be displayed and it puts the gas valve in lockout. Value: the rise in supply temperature needed to confirm ignition has taken place. Time: Duration of time required to pass before the controller will look at the ignition temperature increase.
101	ModGasWarmup	SETPOINT	When the heat is enabled and at start up, the modulating gas valve will remain at the maximum capacity position for the time period selected. Value: the amount of time the Modulating Gas Valve is in the maximum capacity position.
102	AuxHtMin/Max	DELAY	This Setpoint limits the minimum and maximum positions allowed for the modulating gas valve capacity control. Min Capacity Value: the minimum position the modulating gas valve will drive close. Max Capacity Value: the maximum position the modulating gas valve will drive open.
103	WARMUP TEMP	SETPOINT	When enabled in heating this is the maximum temperature the return sensor will be permitted during warm up mode.
104	WARMUP TIME	SETPOINT	When enabled in heating and the unit is in warm up mode this is the maximum amount of time the warm up will be permitted. Value: the amount of time in seconds the warm up state will be permitted.
105	ERW DEFROST	TIME	When the energy recovery wheel is on and the outdoor ambient falls below the value of this setpoint recovery wheel will go through a defrost function for the time period selected. Value: temperature the ambient reaches to enable the defrost function. Time "A": time between defrosts after the ambient enables defrost. Time "B": the amount of time the defrost is enabled once initiated.

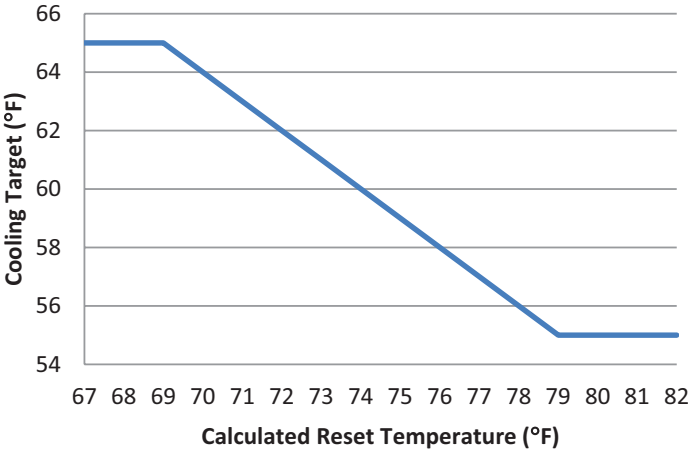
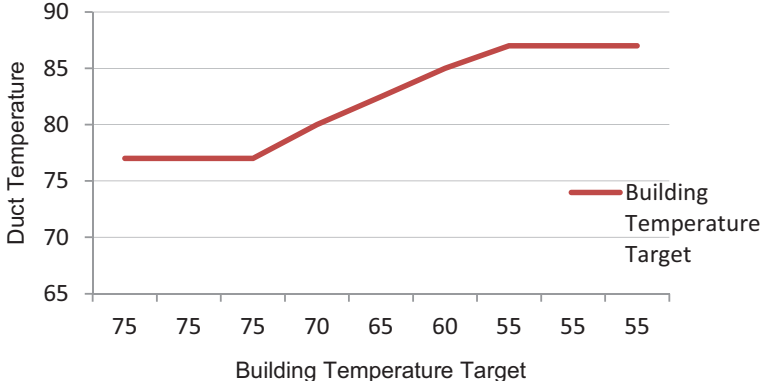

#	Name	Type	Description										
106	REHEAT FLUSH	TIME	<p>When reheat is enabled, this Setpoint will flush the reheat coils based on time.</p> <p>Value: when in reheat mode, a cycle will flush the reheat coils with 100% cooling if the valve is not at a specified value.</p> <p>Time "A": time between flush cycles.</p> <p>Time "B": flush duration of cooling when in reheat.</p> <p>Time "C": flush duration of reheat when in cooling.</p>										
107	GasLoFireDsb	SETPOINT	<p>When heat enabled and modulating gas valve is below this percent, the gas low fire relay will be energized.</p>										
108	SMOKE ALARM	ALARM	<p>This alarm will temporarily shut down the entire unit when a smoke alarm trip has occurred.</p> <p>Value: the number of seconds after the input is energized before the unit will be disabled.</p> <p>Safety Down Time: The number of minutes the smoke alarm must be off before the unit is reactivated.</p>										
		LOCKOUT/ SETPOINT	<p>This lockout/Setpoint will shut down the entire unit when a smake alarm trip has occurred.</p> <p>Value: the number of seconds after the input is energized before the unit will be locked out.</p> <p>Note: If this value is inactive then the Setpoint will be 2 seconds.</p>										
109	COOL RESET +	TARGET	<p>When cooling is ENABLED, the cooling target will be increased linearly based on how close the auto reset temperature is to cooling enable target.</p> <p>Value: The offset to the cool enable Setpoint (Setpoint #1 "COOL ENABLE").</p> <p>Zone: Added and subtracted from the COOL RESET+ value plus the cool enable. If the sensor input for calculated reset is above the zone + value + cool enable Setpoint then no adjustment is made.</p> <p>Max ROC: The maximum amount to increase the cooling target by.</p> <p>Example:</p> <p>The following example graph assumes that the following setup.</p> <table border="1" data-bbox="620 1199 1102 1413"> <tbody> <tr> <td>Cooling Enable:</td> <td>68 °F</td> </tr> <tr> <td>Cooling Target:</td> <td>55 °F</td> </tr> <tr> <td>Value for Cool Reset +:</td> <td>6 °F</td> </tr> <tr> <td>Zone for Cool Reset +:</td> <td>5 °F</td> </tr> <tr> <td>Max ROC for Cool Reset +:</td> <td>10 °F</td> </tr> </tbody> </table>	Cooling Enable:	68 °F	Cooling Target:	55 °F	Value for Cool Reset +:	6 °F	Zone for Cool Reset +:	5 °F	Max ROC for Cool Reset +:	10 °F
Cooling Enable:	68 °F												
Cooling Target:	55 °F												
Value for Cool Reset +:	6 °F												
Zone for Cool Reset +:	5 °F												
Max ROC for Cool Reset +:	10 °F												

#	Name	Type	Description																																		
			<p style="text-align: center;"><b>Example for Setpoint 109, Cool Reset +</b></p>  <table border="1" style="display: none;"> <caption>Data for Example for Setpoint 109, Cool Reset +</caption> <thead> <tr> <th>Calculated Reset Temperature (°F)</th> <th>Cooling Target (°F)</th> </tr> </thead> <tbody> <tr><td>67</td><td>65</td></tr> <tr><td>68</td><td>65</td></tr> <tr><td>69</td><td>65</td></tr> <tr><td>70</td><td>64</td></tr> <tr><td>71</td><td>63</td></tr> <tr><td>72</td><td>62</td></tr> <tr><td>73</td><td>61</td></tr> <tr><td>74</td><td>60</td></tr> <tr><td>75</td><td>59</td></tr> <tr><td>76</td><td>58</td></tr> <tr><td>77</td><td>57</td></tr> <tr><td>78</td><td>56</td></tr> <tr><td>79</td><td>55</td></tr> <tr><td>80</td><td>55</td></tr> <tr><td>81</td><td>55</td></tr> <tr><td>82</td><td>55</td></tr> </tbody> </table>	Calculated Reset Temperature (°F)	Cooling Target (°F)	67	65	68	65	69	65	70	64	71	63	72	62	73	61	74	60	75	59	76	58	77	57	78	56	79	55	80	55	81	55	82	55
Calculated Reset Temperature (°F)	Cooling Target (°F)																																				
67	65																																				
68	65																																				
69	65																																				
70	64																																				
71	63																																				
72	62																																				
73	61																																				
74	60																																				
75	59																																				
76	58																																				
77	57																																				
78	56																																				
79	55																																				
80	55																																				
81	55																																				
82	55																																				
110	USER RESET	SETPOINT	<p>This Setpoint controls the target adjustment between holding the reset button for three seconds.</p> <p>Value: Amount in degrees to increment the temperature by.</p> <p>Max: The maximum temperature that can be set from the user reset.</p>																																		
111	COOL RESET -	TARGET	<p>When cooling is ENABLED, the cooling target will be decreased linearly based on how far away the auto reset temperature is to cooling enable target.</p> <p>Value: The offset to the cool enable Setpoint (Setpoint #1 "COOL ENABLE").</p> <p>Zone: Added and subtracted from the COOL RESET- value plus the cool enable. If the sensor input for calculated reset is below the zone + value + cool enable Setpoint then no adjustment is made.</p> <p>Max ROC: The maximum amount to decrease the cooling target by.</p>																																		
112	HEAT RESET +	TARGET	<p>When heating is ENABLED, the heating target will be increased linearly based on how far away the auto reset temperature is to heating enable target.</p> <p>Value: The offset to the heat enable Setpoint (Setpoint #2 "HEAT ENABLE").</p> <p>Zone: Added and subtracted from the HEAT RESET+ value plus the heat enable. If the sensor input for calculated reset is above the zone + value + heat enable Setpoint then no adjustment is made.</p> <p>Max ROC: The maximum amount to increase the heat target by.</p> <p style="text-align: center;"><b>HEATING RESET +</b></p>  <table border="1" style="display: none;"> <caption>Data for HEATING RESET +</caption> <thead> <tr> <th>Building Temperature Target</th> <th>Duct Temperature</th> </tr> </thead> <tbody> <tr><td>75</td><td>77</td></tr> <tr><td>75</td><td>77</td></tr> <tr><td>75</td><td>77</td></tr> <tr><td>70</td><td>80</td></tr> <tr><td>65</td><td>83</td></tr> <tr><td>60</td><td>85</td></tr> <tr><td>55</td><td>87</td></tr> <tr><td>55</td><td>87</td></tr> <tr><td>55</td><td>87</td></tr> </tbody> </table>	Building Temperature Target	Duct Temperature	75	77	75	77	75	77	70	80	65	83	60	85	55	87	55	87	55	87														
Building Temperature Target	Duct Temperature																																				
75	77																																				
75	77																																				
75	77																																				
70	80																																				
65	83																																				
60	85																																				
55	87																																				
55	87																																				
55	87																																				

#	Name	Type	Description
113	HEAT RESET -	TARGET	<p>When heating is ENABLED, the heating target will be decreased linearly based on how close the auto reset temperature is to heating enable target.</p> <p>Value:                      Max ROC: The maximum amount to decrease the heating target by                      Zone:</p> <div style="text-align: center;"> <p><b>HEATING RESET -</b></p> <p>Cooling Target</p> <p>90 85 80 75 70 65</p> <p>55 70</p> <p>Building Temperature</p> <p>Setpoint #10</p> <p>Setpoint #10 - MAX ROC</p> <p>Building Temperature Target</p> </div>
114	PRECOOL TARG	TARGET	<p>When in Precooling is active, the system will maintain this value for the precooling control sensor selected.</p> <p>Value: The temperature that Precooling Capacity Control will maintain.</p> <p>Zone: Will adjust the capacity control to maintain the temperature and target range for Precooling.</p> <p>MAX ROC Value: The MAX Rate of Change that the capacity control will allow to determine loading or unloading.</p> <p>ROC Interval: The Time Interval over which the rate of change is calculated.</p> <p>Adjust multiplier/divider value: Scales any calculated changes to the cooling capacity.</p>
115	PRECOOL ADJ	DELAY	<p>This Setpoint determines how quickly to adjust the precooling capacity. The farther the sensor is from target the quicker the precool Adjust will work to reach the Setpoint.</p> <p>Value: The adjustment delay for the precooling capacity control.</p> <p>MIN Adjust % Value: Precooling capacity will not be adjusted less than this value.</p> <p>MAX Adjust % Value: Precooling capacity will not be adjusted more than this value.</p> <p>MIN Capacity % Value: Precooling capacity will not be less than this value.</p> <p>MAX Capacity % Value: Precooling capacity will not be more than this value.</p> <p>Delay multiplier/divider value: Scales any calculated changes to the precooling step delay.</p>

#	Name	Type	Description
116	CFM TARGET	TARGET	When the supply fan is needed, this Setpoint will maintain a specified flow rate. Value: The cubic feet per minute that will be maintained. Zone: Will adjust the capacity control offset to maintain the CFM target Setpoint. MAX ROC Value: The MAX rate of change that the supply fan control will allow to determine increase or decrease to the supply fan offset. ROC Interval: The time interval the rate of change is calculated. Adjust multiplier/divider value: Scales any calculated changes to the CFM Target.
117	CFM STP DELY	DELAY	This Setpoint determines how quickly to adjust the supply fan capacity offset. The farther the sensor is from target the quicker the step delay will work to reach the Setpoint. Value: The adjustment delay for the supply fan capacity control. MIN Adjust % Value: Supply fan capacity offset will not be adjusted less than this value. MAX Adjust % Value: Supply fan capacity offset will not be adjusted more than this value. MIN Capacity % Value: set to 0% MAX Capacity % Value: Set to 100% Delay multiplier/divider value: Scales any calculated changes to the CFM STP DELY.
118	MaxStaticRst	SETPOINT	This Setpoint value defines the maximum change in either direction that the static target will be offset.
119	HOOD DEH ENB	SETPOINT	When hood switch is on, if there is an ambient dew point sensor, this Setpoint is used in place of the humidity enable value.
120	NO FLOW	SETPOINT	If a proof of air flow switch is present, then NO FLOW should be programmed as a Setpoint. Creates an alarm if air flow has not been proved for a number of second equal to the value of the Setpoint.
120	NO FLOW	ALARM	If there is not a proof of air flow switch is present, then NO FLOW must be programmed as an alarm. Value: The duct static pressure necessary to trigger a no flow state. Time: Duration of time required to pass while the duct static pressure is below the value before the alarm will trigger.
121	Cool UnldOff	SETPOINT	While in cooling mode, if the current cooling value is a number of degrees, defined by the value of this Setpoint, below the cooling target, it allows for the compressors to shut off until the capacity control calls for more capacity
122	Heat UnldOff	SETPOINT	While in heating mode, if the current heating value is a number of degrees, defined by the value of this Setpoint, above the heating target, it allows for the compressors to shut off until the capacity control calls for more capacity
123	DEH UnldOff	SETPOINT	While in dehumid mode, if the current suction temperature is a number of degrees, defined by the value of this Setpoint, below the target suction temperature defined in Setpoint 23, "DehSucTmpTrg", it allows for the compressors to shut off until the capacity control calls for more capacity
124	FREEZE UNLD	ALARM	This Setpoint will unload compressors with variable capacity to prevent a supply freeze alarm. Value: The degrees above Setpoint #86 "FREEZE TEMP" in which unloading will be active. Tripped Delay: The number of seconds the compressor will wait before unloading.

#	Name	Type	Description
125	FREEZE RELD	SETPOINT	If the system has had a freeze unload, after the safety period, it will reload if the supply temperature has gone above the reload Setpoint. Value: The number of degrees above Setpoint #86 "FREEZE TEMP" that reload will be active, if unload was active.
126	CondStart %	SETPOINT  (TIME)	Whenever the condensers are first started, the Setpoint value will determine the starting percentage of the condenser fans.  <b>WATERSIDE ECONOMIZER LOGIC:</b> The condenser valve will go to the set position defined in the Time B field of the setpoint during economizer only operation. If not in economizer mode the condenser valve will be set to the value of the setpoint until a compressor is started and then it will modulate to maintain discharge pressure. When compressors and economizer are on, the economizer is set to 100% and condenser valve will be modulated to discharge target.
127	HI DUCT PSI	ALARM	This Setpoint will post a HI DUCT PSI Alarm if the Duct PSI SI has been tripped for certain amount of time. Value: The number in PSI that is reached before posting a HI DUCT PSI Alarm. Time: The number of seconds before the Alarm is sent.
		LOCKOUT	This Setpoint will lock out the unit and post a HI DUCT PSI if the HI DUCT PSI alarm has occurred. Value: The number in PSI that is reached before posting a HI DUCT PSI Alarm. Time: The number of seconds before the Lockout is sent.
128	WtrVlvFreeze	SETPOINT	
129	ERW MIN DIFF		
130	G-RATOR STBK		
131	MODGAS STAGE %		
132	EXV TARGET	TARGET	EXV control is bases on superheat. Valve is the target the MicroMag will control from. Zone: is the dead band around the superheat target. Max Roc Value: The max Roc that the EXV control will allow to determine opening or closing of the EXV. ROC Interval: The time interval the Roc is calculated over. Adjust Mult/Div: Scales any calc. changes to EXV value based on controlling SI'S proximity to the target.
133	EXV ADJUST	DELAY	Determines how quickly to adjust the EXV valve percentage. The farther the superheat is from the target the quicker the step delay will work to reach setpoint. Min Adjust % Valve: EXV value % will not be adjusted greater than this value. Max Adjust Valve %: EXV valve % will not be adjusted gresater than this value. Min Cap %: EXV min % position. Max Cap %: EXV max % position. Delay M/O: Scales calc changes to EXV step delay.
134	EXV LO SPRHT	TIME	If calc superheat remains below this value a safety trip occurs.
135	EXV MOP TARG	TARGET	Value is max suct PSI that EXV control will allow before closing off valve. Zone: DB around target PSI. ROC: Setting are the same. Adjust M/O: Scales calc changes to EXV % based on MOP target controlling PSI's proximity.

#	Name	Type	Description
136	FIRE ALARM	SETPOINT	This alarm will temporarily shut down the entire unit when a fire alarm trip has occurred. Value: the number of seconds after the input is energized before the unit will be disabled. Safety Down Time: The number of minutes the smoke alarm must be off before the unit is reactivated.
137	CONDSATN ALM		
138	DAMPER FAULT		
139	OAD ON POS		
140	PREHEAT TARG		
141	PREHEAT ADJ		
142	ERW ALARM		
143-145	SPARE SETPOINT		NOT USED
146	EXV LOAD ADJ		
147	DisPsiHtTape		
148	OIL LEVEL		
149-200	SPARE SETPOINT		NOT USED

## Chapter - 24. COOLING SETPOINTS

### 24.1. List of Cooling setpoints

**SETPOINT 34 –LOW AMBCOMPOFF**—The minimum temperature measured with the Outside Air Temp the compressors are allowed to operate.

**SETPOINT 39 –COMP MIN RUN**—The minimum number of minutes the compressor must run. This is used to get the compressor discharge temp above 117F and the discharge superheat above 20 to get good oil separation.

**SETPOINT 40 –ACYC ON-ON**—The time from compressor turns off to when it can restart. This limits the number of starts per hour.

**SETPOINT 41 –ACYC OFF-ON**—The time the compressor must be off before restarting after turning off.

**SETPOINT 45 –SFTY UNL DLY**—If a compressor is about to go into a safety it will wait this long before starting to un-load

**SETPOINT 46 –SFTY HLD DLY**—This is how long the unit will stay in the safety hold state.

**SETPOINT 47 –SFTY UNL ADJ**—Percentage of unload when a compressor goes into an unload state.

**SETPOINT 48 –COMPSTARTUP%**—This is the starting % of the compressor whether it is a Digital or Frequency drive controlled.

**SETPOINT 50 –CMP ADJ DLY**—How long the compressor will wait between adjustments if the adjustment is more than its maximum adjustment.

**SETPOINT 51 –COMP 1 FLA**—This is the full load amps for compressor 1.

**SETPOINT 52 –COMP 2 FLA**—This is the full load amps for compressor 2.

**SETPOINT 53 –COMP 3 FLA**—This is the full load amps for compressor 3.

**SETPOINT 54 –COMP 4 FLA**—This is the full load amps for compressor 4.

**SETPOINT 55 –LOW AMP %**—This is the low % amp position for the compressors. At startup if the compressor does not achieve this % the compressor is shut down and a 'Low Amps' Alarm is posted. This usually indicated by a mechanical failure of holding off the compressor.

**SETPOINT 56 –HIGH AMP %**—This is the high load amp %. If the system cannot recover the compressor it will be locked out.

**SETPOINT 57 –HiAmpUnldHld**—If the compressor is  $\geq$  this % current the compressor will attempt to unload. Once it is below this current it will hold until it goes below 100%

**SETPOINT 62 –LOW SUCT PSI**—If a low suction pressure occurs the system will try to correct the problem if it can be modulated. If the problem cannot be avoided the compressor will follow the safety lockout procedure.

**SETPOINT 64 –UNSAFE SUCT**—Unsafe suction is a situation where the compressor should not be functioning. The unsafe value is designed to save the compressor if a pipe breaks, etc.

**SETPOINT 65 –LO SUCT UNLD**—Low suction an area the compressor cannot operate for too long a period before freezing or damaging coils. If the compressor has variable capacity the system will decrease the capacity to avoid shutting down. The system is designed to provide as much capacity as possible without shutting down.

**SETPOINT 66 –LO SUCT RELD**—If the system has had a low suction unload, after the safety period, it will reload if the suction pressure has gone above the reload setpoint.

**SETPOINT 67 –LOW SUCT SPHT**—The system protects against low suction superheat if the sensors are available. If the condition occurs the affected compressor will be shut down as a safety. Safety algorithms apply.

**SETPOINT 68 –HI SUCT SPHT**—The system protects against high suction superheat. If the condition occurs the affected compressor will be shut down as a safety. Safety algorithms apply.

**SETPOINT 70 –HI DISC PSI**—When the condenser is fully loaded and if the compressor on this circuit is modulating it will start to unload. If the system cannot bring the condition under control within the allocated time the circuit will go into a safety. Safety algorithms apply.

**SETPOINT 71 –HI DISC UNLD**—This is the state entered when the system unloaded due to high discharge pressure.

*SETPOINT 72* –**HI DISC RELD**—After the specified time in High Discharge Unload the system will reload if the pressure is met.

*SETPOINT 86* –**FREEZE TEMP**—If the supply temperature goes below this value for the time specified the system goes into a safety. Safety algorithms apply



## Chapter - 25. HEATING, REHEAT & CONDENSER SETPOINTS

### 25.1. List of SETPOINTS

#### Modulating Gas Heat

**SETPOINT 100 –IGN PROOF**—This is the maximum time for ignition. If the supply temperature doesn't rise enough within the specified time the Gas module goes into a safety. Safety algorithms apply

**SETPOINT 101 –MODGASWARMUP**—Once ignition has been proved this is the amount of time the mod gas module remains in warmup prior to standard control.

**SETPOINT 102 –AUXHTMIN/MAX**—This controls the minimum and maximum positions for the modulating gas valves.

#### Reheat

**SETPOINT 106 –REHEAT FLUSH**—If the reheat has run then a flush cycle will occur based on this time. If the unit is in reheat and the demand is less than the setpoint value, the unit will allow flushing. TimeA is the delay between flush cycles, time B is the duration of the flush cycle (to 100% cooling) when the unit is in reheat, and time C is the duration of the flush cycle (to 100% reheat) when the unit is in cooling.

#### Air Heat Pumps

**SETPOINT 92 –HP AMB DEFR**—When ambient is above this value the defrost cycle will be disabled.

**SETPOINT 93 –DEF TERM TMP**—When in defrost it will be terminated when this temp is reached.

**SETPOINT 94 –MaxDefRunTim**—Maximum time allowed to run in defrost.

**SETPOINT 95 –WtdDefDur%**—This is the % of the maximum defrost duration that the defrost algorithm controls to.

**SETPOINT 96 –BtweenDefAdj**—This is the number of seconds that will be added to or subtracted from SP #95 if the defrost just completed is more time or less time than specified.

**SETPOINT 97 –DelyBtwnDef**—The system will wait after completing a defrost and starting the next for this time.

**SETPOINT 98 –HPCndTrgOfst**—Heatpump condenser offset. This provides a significant improvement in the amount of heat being generated.

#### Head Pressure

**SETPOINT 17 –COND TARGET PSI**—This is the condenser target when in cooling mode. The +/- value defining the zone is set based on 'ZONE VALUE'

**SETPOINT 18 –COND STP DLY**—This defines the time between condenser adjustments.

**25.2. Revision Page**

<b>Date</b>	<b>Author</b>	<b>Description of Changes</b>
06-14-16	DEW	Created MicroMag RTU Manual Rev2.0
10-25-16	DEW	Update Graph Section
11-18-16	DEW	Update to RO-10 AND SI-16 PHOTOS
02-15-16-17	DEW	Add Multiplier/divide into to setpoints- Graphics update
06-16-17	DEW	Add BMS Alarm Chart
04-10-18	DEW	Make changes to setpoint 126 as per DC
01-14-19	DEW	Make changes to the BMS Alarms section
12-06-19	DEW	Show Authorization page before Menus- example how to change setpoints
05-01~28-2020	DEW	Add BACnet MSV UNIT STATE MSV:0
06-02-2021	DEW	Add ADMIN to authorization page
07-13~16-2021	DEW	Update screen shots, update using chiller manual
01-21-2022	DEW	Add Scrolling LCD information
07-20-2023	DEW	change port # for RS485



*Providing HVAC/R Control Solutions Worldwide*

5580 Enterprise Pkwy. Fort Myers, FL 33905

Office: (239) 694-0089

Fax: (239) 694-0031

[www.mcscontrols.com](http://www.mcscontrols.com)