



*MCS Total
Solutions for all your
Control Needs*



CHILLER PLANT MANAGER CONTROLLER

MCS CONFIGURATION

Typical Configuration for 3 Chillers



MCS-MAGNUM -LB
with CPM V17
FIRMWARE

MCS-MAGNUM CHILLER PLANT MANAGER

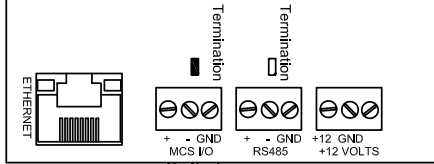

CHILLER PLANT MANGER EXPANSION BOARDS

Communications from MCS-S16-AO4 #1
(shield not connected at this end)

MCS-MAGNUM CHILLER #1

MCS-MAGNUM -LB
with HVAC V17
FIRMWARE

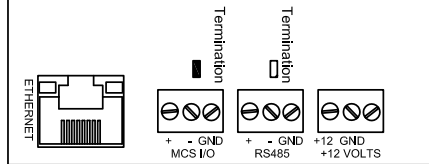

MCS-MAGNUM CHILLER #2

MCS-MAGNUM -LB
with HVAC V17
FIRMWARE

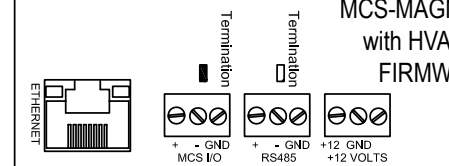

MCS-MAGNUM CHILLER #3

MCS-MAGNUM -LB
with HVAC V17
FIRMWARE

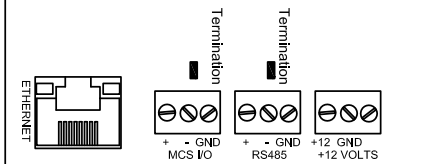

**UP TO
10 CHILLER
MAGNUMS**

Complete Plant Controls

- Network connectivity up to 10 Chillers with MCS-Magnum controllers
- Control for multiple chiller water pumps, with primary/standby, rotation, variable speed
- Control for multiple cooling towers with primary/standby, rotation, variable speed
- MCS-CHILLER PLANT MANAGER can be hard wired to your plant system.

MCS Plant Manager Features

1.1. MCS-Chiller Plant Manager (CPM) V17

This software family is designed to control a site that consists of multiple chiller packages that are being controlled by individual controllers. The Plant Manager will control the process pumps to ensure that the required water flow is maintained and then stage the chiller packages to meeting the cooling requirements of the site. The Plant Manager is based upon the CPM V17 and Chiller HVAC V17 software family.

The Plant Manager will maintain water flow by controlling the pumps. To determine the site needs, the Plant Manager will compare the control temperature to the temperature target and develop the step capacity needed.

The Plant Manager can also review an input signal that limits its loading capacity. This is used for load limiting.

Communications between the Plant Manager and the MCS-MAGNUMS on the chiller packages is accomplished over the RS485 network. Messages are transmitted to the MCS-MAGNUMS that indicate if that package can run and the maximum number of steps if fixed step system or maximum demand capacity if a variable step system. The Plant Manager will also report if a package is not responding or if an error condition exists on that package. If the Plant Manager or the RS485 network fail, the individual MCS-MAGNUMS will control their chiller packages independently.

All chiller safeties are preformed by the individual controllers.

- The system will support up to three loops and control each loop independently.
- Each loop will support:
 - Up to eight pumps with one variable speed with control on a specified sensor or a delta pressure,
 - Up to sixteen stages of cooling-ice making with one variable speed,
 - Up to sixteen stages of heating with one variable speed,
 - Run/stop switch, run override (occupancy) indicator,
 - Individual schedule options can be selected,
 - Controlling sensor for the stages of heating and cooling-ice making,
 - Each pump can have its own sensor analog, digit or both to indicate a failure.
 - Each VSD can have its own sensor to indicate a failure.
 - Common support items of the Plant Manager Software Family:

Relay Outputs up to 48, Analog Outputs up to 6, Sensor Inputs up to 48, Setpoints up to 120, Alarms up to 60

Available options per loop:

- Loop #1 can receive a load limiting input.
- Run enable can be based upon a run switch or a run switch plus temperature input.
- Pump/Fan/Damper control: Automatic rotation can be selected. Number of pumps allowed on can be less than number of pumps available. This enables automatic backup.
- Override: If input is pressed the system will be in override, occupancy, mode for the time specified in setpoint #1.
- Scheduling options: The unit can be scheduled to always run, based upon a day of week schedule or non-peak demand hours. Peak hours are indicated by the individual months.
- Ambient Temperature: If the ambient temperature is low, below setpoint #2 the loop can be turned off or only the pumps allowed to run. This is to prevent freezing. Or, the loop can only run on high ambient, temperature above setpoint #2.
- Ice making: A loop can be used to control an ice making function. If selected the ice making can be terminated on the ice level, temperature or both. The ice making function can only be entered once when the unit is in a run mode and the loop indicates that ice is to be made.
- Sample applications:
 - Provide centralized site control with either fixed step or variable capacity compressors.

MCS CONFIGURATION

MCS-MAGNUM

- S-PMP 1% 5% (shield grounded at this end only)
- S-PMP 2% 2% (shield grounded at this end only)
- S-PMP 3% 3% (shield grounded at this end only)
- S-PMP 4% 4% (shield grounded at this end only)
- SENSOR M-1
- S-Pmp1 Flt
- SENSOR M-14
- S-Pmp2 Flt
- SENSOR M-15
- S-Pmp3 Flt
- SENSOR M-16
- RUN/STOP

NOTE:
1, Drain shield must be cut at BOTH ends.

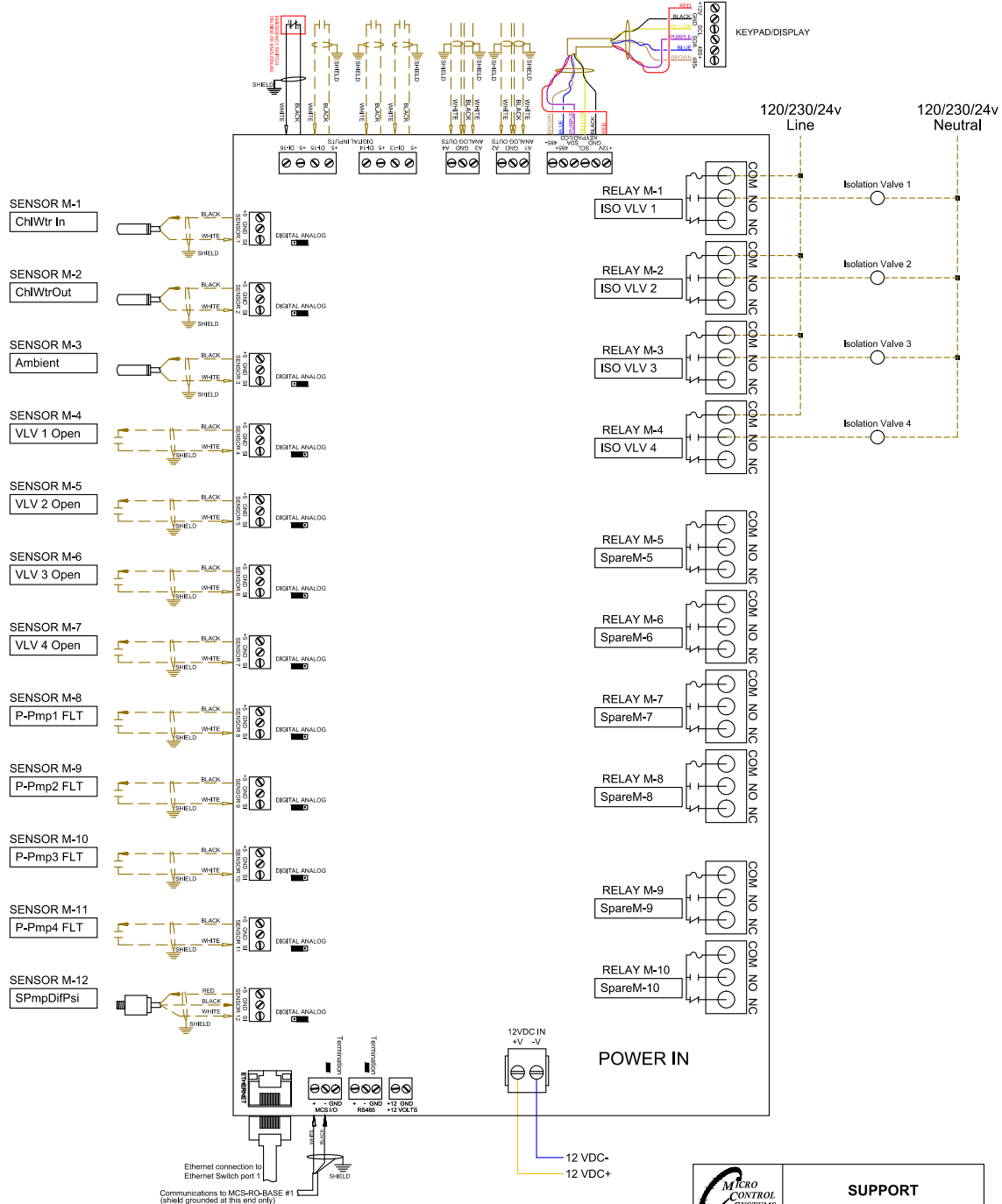

MICRO CONTROL SYSTEMS		SUPPORT	
SO# 000000	Micro Controls Systems		
Unit Type	MCS		
Drawing #	000000-01		
Revision	1a	08/09/2023	
CAD Tech	ILM	Page 1 of XX	

MCS Standard Components

Built in Standard Components

Additional Options are available

MCS-MAGNUM-N

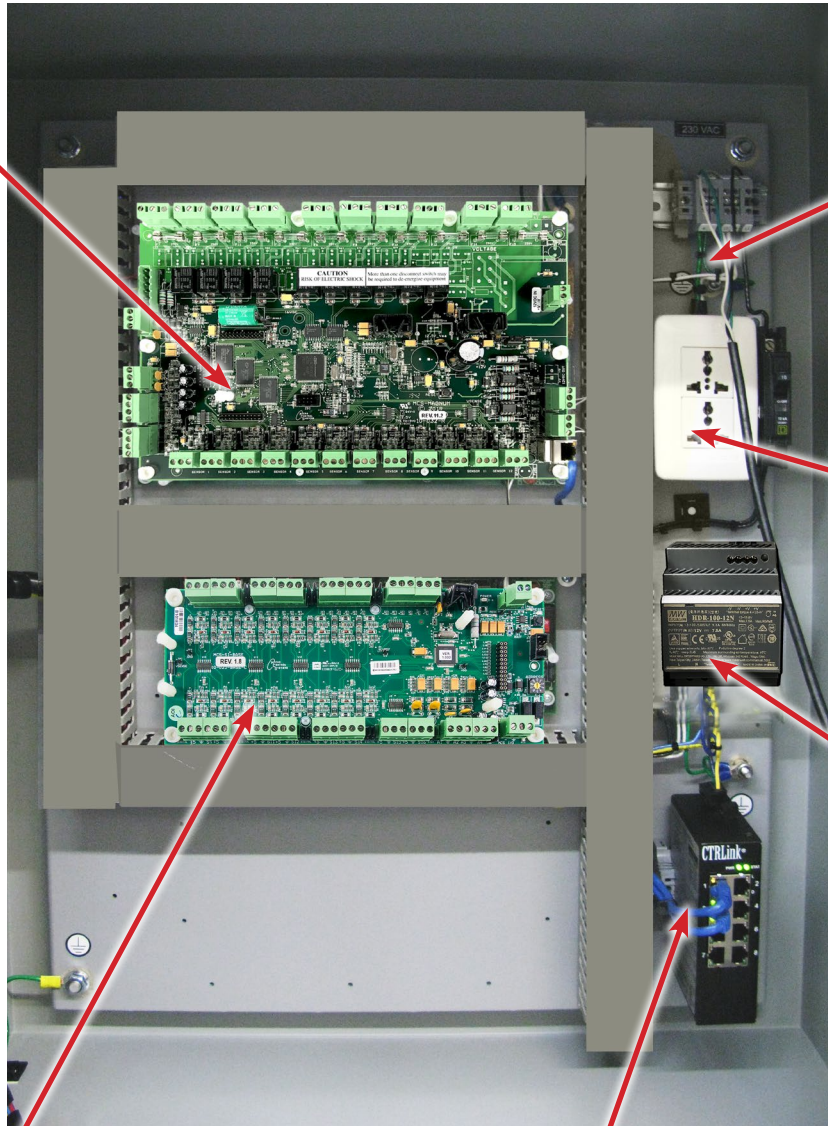

Terminal Blocks
to land hots
and neutrals
for devices

GFCI Electrical
outlet for
Laptop plug -in
power
at the box

90w Single Output
Power Supply
for Touchscreen

**MCS-SI-Base
Expansion Board**

Five (5) port Ethernet Switch

MCS Enclosures Available

Additional Options are available

MCS-MAGNUM-LB-15.4

The **MCS-MAGNUM-LB-15.4** enclosure is made of powder coated aluminum for durability and longevity. A left hand swing door is mounted with three eight-inch hinges for strength. A key lock is provided for security on the door while still giving easy access of the display. This box is intended for use in an environment protected from the weather.

The **MCS-TOUCH-15.4** is a new touchscreen interface designed to simplify user access with the MCS-MAGNUM utilizing **MCS-CONNECT** to provide both graphics and service mode access to technicians. Information and graphics on the MCS-TOUCH-15.4 are shown on a 15.4" high resolution (1280x800) LCD display with LED backlighting, which will guarantee long-life operation.

The following warning lights and switches are included in the standard enclosure;

- Hand/Auto/Off Switch
- Status Lights
- Fault Lights



MCS-MAGNUM NEMA4-15.4

The **MCS-MAGNUM-NEMA-15.4** enclosure is made of powder coated aluminum for durability and longevity. The interior left hand swing door is mounted with three four-inch hinges for strength. The enclosure is designed for areas which may be regularly hosed down or are in very wet or oily conditions. The enclosure provides protection from dust, dirt, oil and water.

The **MCS-TOUCH-15.4** is a new touchscreen interface designed to simplify user access with the MCS-MAGNUM utilizing **MCS-CONNECT** to provide both graphics and service mode access to technicians. Information and graphics on the MCS-TOUCH-15.4 are shown on a 15.4" high resolution (1280x800) LCD display with LED backlighting, which will guarantee long-life operation.

The following warning lights and switches are included in the standard enclosure;

- Hand/Auto/Off Switch
- Status Lights
- Fault Lights



MCS TOUCHSCREEN

MCS-TOUCH-15.4

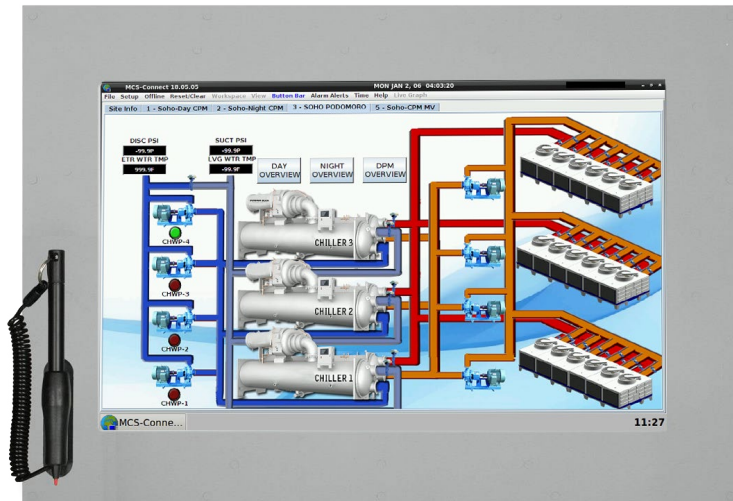

MCS-CHILLER PLANT MANAGER
DISPLAYING CUSTOM GRAPHICS

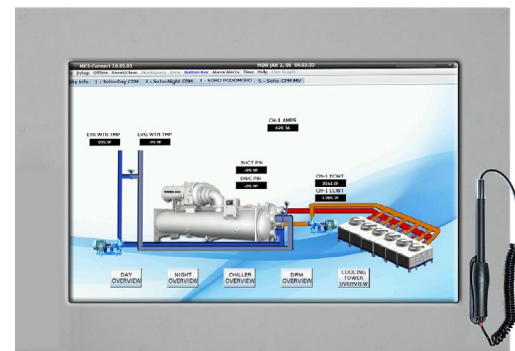

Custom Graphics for your plant configuration can be designed to show the operation of the chillers that the **MCS CHILLER PLANT MANAGER** is communicating with. Vital information will be displayed on the MCS-TOUCH CPM display in your control room. Various graphics screens can be designed to help see the information of the plant chillers and their operation.

MCS-Connect, a software program designed to communicate with different sensors and relays can be utilized to provide information as to water flow, compare temperature targets, etc. and send this information to the CPM graphical display.

Information and graphics on the **MCS-TOUCH** are shown on high resolution (1280x800) LCD display with LED back lighting, which guarantees long-life operation.

The **MCS-TOUCH-15.4** is a WeatherProof Touchscreen interface designed to simplify user access with the MCS-Magnum Controller.

Box Enclosures for the MCS-TOUCH-15.4 and the MCS-CHILLER PLANT MANAGER software range in size from:

- **MCS-MAGNUM-LB-15.4 ENCLOSURE**
- **MCS-MAGNUM-NEMA4-15.4 ENCLOSURE**

A NEMA4 Box Enclosure must be used for outdoor installation or for areas that are subject to water wash-down or extreme harsh environments.

Other options available, call 239-694-8900 or email sales@mcscontrols.com



5580 Enterprise Pkwy., Fort Myers, FL 33905

Office: 239-694-0089 • Fax: 239-694-0031

www.mcscontrols.com