



5580 Enterprise Pkwy.
Fort Myers, FL 33905

Office: 239-694-0089
Fax: 239-694-0031

www.mcscontrols.com

MicroMag Chiller

Firmware Ver. 18
Rev. 1.7.6 - 01-21-2022



The MicroMag is a rugged microprocessor based controller designed for the hostile environment of the HVAC/R industry. It is designed to be the primary manager of the package it is controlling.

**MCS Total
Solution
for all your
Control
Needs**



Energy Efficient and RoHS Compliant

The MCS Commitment is to provide practical solutions for the industries needs and to be both a leader and partner in the effective use of microprocessor controls.

Micro Control Systems, Inc.
5580 Enterprise Parkway
Fort Myers, Florida 33905
PH:(239) 694-0089 FAX:(239) 694-0031

www.mcscontrols.com

All information contained within this document is considered to be proprietary information of Micro Control Systems, Inc. No information or data from this document shall be published, used, reproduced, transmitted, or disclosed to others outside your organization without the prior expressed written consent of Micro Control Systems, Inc. This document and the information contained herein shall be treated as proprietary. Reasonable provisions shall be provided to ensure that this information remains proprietary by your employees, agents, and other personnel that may have access to this document.
Copyright ©2021

Table of Contents

Chapter - 1. MicroMag Hardware	7
1.1. MicroMag - Hardware Rev. 7.0 and greater- Firmware V18.00 and up	7
1.2. MicroMag without Cover	8
1.3. MicroMag with Cover	8
1.4. MicroMag-12-Nema 4	8
Chapter - 2. MicroMag Optional Expansion Boards	9
2.1. MCS-SI-BASE and MCS-SI-EXT	9
2.2. MCS-RO-BASE and MCS-RO-EXT	9
2.3. MCS-IO-BASE and MCS-IO-EXT	10
Chapter - 3. AUTHORIZATION FUNCTION	11
3.1. Authorized via the Keypad/LCD	12
3.2. Authorized via MCS-CONNECT	12
Chapter - 4. MicroMag Keypad	13
4.1. Main Menu Status	13
4.2. Service Tools	14
4.3. Viewing Alarms And Events	18
4.4. Lockout - Clear	18
4.5. Changing Values of a Setpoint	19
4.6. Viewing the Current Status of the Unit	20
Chapter - 5. MicroMag Communications Options	21
5.1. MicroMag's using MCS-CONNECT - MCS-USB-RS485	21
5.2. Multiple MicroMag's using MCS-CONNECT - RS485 and MCS-Touchscreen	22
5.3. Multiple MicroMag's, over Internet using MCS-Connect & MCS-ETHERNET-RS485	23
Chapter - 6. MCS-CONNECT Software Support	24
Chapter - 7. MCS-CONNECT Screens	25
7.1. MicroMag STATUS	25
7.2. MicroMag RELAY OUTPUTS	26
7.3. MicroMag ANALOG OUTPUTS	26
7.4. MicroMag SENSOR INPUTS	27
7.5. MicroMag CONTROL STATES	28
7.6. MicroMag RESET/CLEAR	29
7.7. MicroMag ALARMS	29
7.8. List of Alarms Generated by MicroMag	30
7.9. MicroMag SCHEDULES	31
7.10. MicroMag INFORMATION SCREEN	31
Chapter - 8. MCS-CONNECT WITH GRAPHICS	32
Chapter - 9. MCS-CONNECT - GRAPHICS	32
9.1. Graphics Screen	32
9.2. Changing the Graphics	33
9.2.1 Graphics File Update	34
Chapter - 10. Displaying Setpoints	35
10.1. Keypad/Display	35
10.2. MCS-Connect	35
10.2.1 MCS Chiller setpoints for HVAC unit being monitored	35
Chapter - 11. MICROMAG ALARMS - MCS-CONNECT	36
Chapter - 12. Graph Capabilities of MicroMag and MCS-CONNECT	38
12.1. Graph Setup Tabs	40
12.1.1 Graph Setup Button	40
12.1.1.1 Interval and Y AXIS SETUP	40
12.1.2 Refresh Data Button	41
12.1.3 Save History Button	41

12.1.4	Print Graph	41
Chapter - 13.	Diagnostic Save ‘EASY BUTTON’	42
13.1.	Diagnostic Save.....	42
Chapter - 14.	MCS-CHILLER MODES OF OPERATIONS	43
14.1.	MicroMag Scheduling.....	43
14.2.	MicroMag Proof of Flow.....	43
14.3.	MicroMag Warning Notification.....	43
14.4.	MicroMag Alarm Notification.....	44
14.5.	MicroMag Lockout Alarm Information.....	44
14.6.	MicroMag Chiller - Control On.....	44
14.7.	MicroMag Data Trending.....	44
14.8.	MicroMag Compressor Types.....	45
Chapter - 15.	MCS-CONFIG	46
15.1.	SETUP SCREEN	46
15.1.1	DEFAULT LCD DISPLAY.....	47
15.1.2	SETUP EXPANSION BOARDS / THERMOSTAT.....	47
15.1.3	DAYLIGHT SAVING TIME	47
15.2.	MicroMag MCS-Config	48
15.2.1	General Info.....	48
Chapter - 16.	MCS-CHILLER CONTROL STATES	49
16.1.	MICROMAG UNIT STATES.....	49
16.2.	COMPRESSOR STATES	50
16.3.	CONDENSER STATES	51
16.4.	PUMP STATES.....	51
16.5.	COOLING STATES.....	52
	SUPERVISOR (BMS) - BMS controls the staging.	52
16.6.	EXV STATES.....	52
16.7.	EXV LOGIC	53
16.7.1	EXV TARGET (Setpoint #132).....	53
16.7.2	EXV ADJUST (Delay) (Setpoint #133).....	54
16.7.3	EXV LOW SUPERHEAT (Time) (Setpoint #134).....	54
16.7.4	EXV MOP (Maximum operating pressure) TARGET (Setpoint #135).....	54
16.8.	HGB_CONTROL (STPT #143).....	54
16.9.	Variable Speed Process Pump Control	55
16.9.1	Setpoint #144 PrcsPumpTarg— (Target Type)	55
16.9.2	Setpoint #145 PrcsPump ADJ (Delay Type).....	55
16.10.	Chilled Water Pump Control	56
Chapter - 17.	MCS-CHILLER STARTUP SEQUENCE	57
17.1.	Power Up.....	57
17.2.	Operational Modes	57
17.2.1	UNOCCUPIED OPERATION.....	57
17.2.2	SCHEDULING	57
17.2.3	Cooling Mode.....	57
17.2.4	Capacity Control	57
17.2.5	Condenser Fan	57
Chapter - 18.	BMS COMMUNICATION	58
18.1.	BACnet Properties	58
18.2.	MICROMAG PROTOCOLS.....	58
18.2.1	BACNET PROTOCOL DEVICE ID	59
18.2.2	Network inputs to MicroMag	59
18.3.	BMS Sensor Input Points	60
18.4.	BMS Relay Output Points.....	61
18.5.	BMS Analog Output Points.....	62
18.6.	BACnet MS/TP BMS Setpoints	63

18.7.	BACnet MS/TP Unit Control Information	67
18.8.	BACnet Compressor States	68
18.9.	BMS Writable Network Points Information	70
18.10.	BMS Points Writable Setpoint Points Grid Information.....	70
18.11.	BMS SI Information	70
18.12.	BMS RO Information - MCS-BMS-GATEWAY	71
18.13.	BMS AO Information - MCS-BMS-GATEWAY	72
18.14.	BMS Unit Control - MCS-BMS-GATEWAY	72
18.15.	BMS Compressor/Condenser Points - MCS-BMS-GATEWAY	73
18.16.	Writeable Network Points- MCS-BMS-GATEWAY.....	75
Chapter - 19.	BMS STATE LIST	76
19.1.	CHILLER_ALGO_STATE_LIST.....	76
19.2.	BACNET_MSV_OCCUPATION_MODE MSV:1	76
19.3.	BACNET_MSV_NETWORK_RUN_STOP MSV:2.....	77
19.4.	BACNET_MSV_EVAPORATOR_STATE MSV:10.....	77
19.5.	BACNET_MSV_COOLING / PRECOOLING STATES	78
19.6.	COMPRESSOR STATES	79
19.7.	CONDENSER STATES	80
19.8.	HEATING / IGNITION STATES - RTU ONLY	81
19.9.	REHEAT STATE - RTU ONLY	82
19.10.	ECONOMIZER STATE	82
19.11.	EXHAUST STATE.....	83
19.12.	EXV STATES.....	84
Chapter - 20.	BMS COMMUNICATION PROTOCOLS	85
19.13.	Reading Alarm Points For MicroMag.....	85
Chapter - 21.	MICROMAG BMS ALARMS	87
21.1.	MICROMAG ALARMS DETAILS REFERENCE NUMBERS.....	89
Chapter - 22.	TROUBLESHOOTING QUICK REFERENCE	98
Chapter - 23.	MicroMag Chiller Setpoints	100
23.1.	Setpoint Types.....	101
23.1.1	SETPOINT	101
23.1.2	LOCKOUT.....	101
23.1.3	ALARM.....	101
23.1.4	Time	102
23.1.5	Target.....	102
23.1.6	Delay.....	102
23.1.7	Minimum Capacity	102
23.1.8	Warning.....	103
23.1.9	Enable.....	103
23.2.	Window/Safety extension	103
23.2.1	Time and seconds to ignore for setpoints	103
23.3.	CALCULATION MADE IN SETPOINTS IN MICROMAG FIRMWARE.....	104
23.4.	MicroMag CHILLER SETPOINTS	105
23.5.	Revision Page	126

PAGE LEFT BLANK

Chapter - 1. MicroMag Hardware

The MicroMag is available as 12vdc system supported by a MCS-RO-Base, MCS-RO-Ext, MCS-SI-Base, MCS-SI-Ext expansion boards The system can support the following:

- Triac Output for a Digital Scroll
- up to 42 Sensor Inputs either Analog or Digital
- Up to 26 Relay Outputs fused at 5 Amps
- Up to 12 Analog Outputs (0/10 VDC or 10/0 VDC)

1.1. MicroMag - Hardware Rev. 7.0 and greater- Firmware V18.00 and up

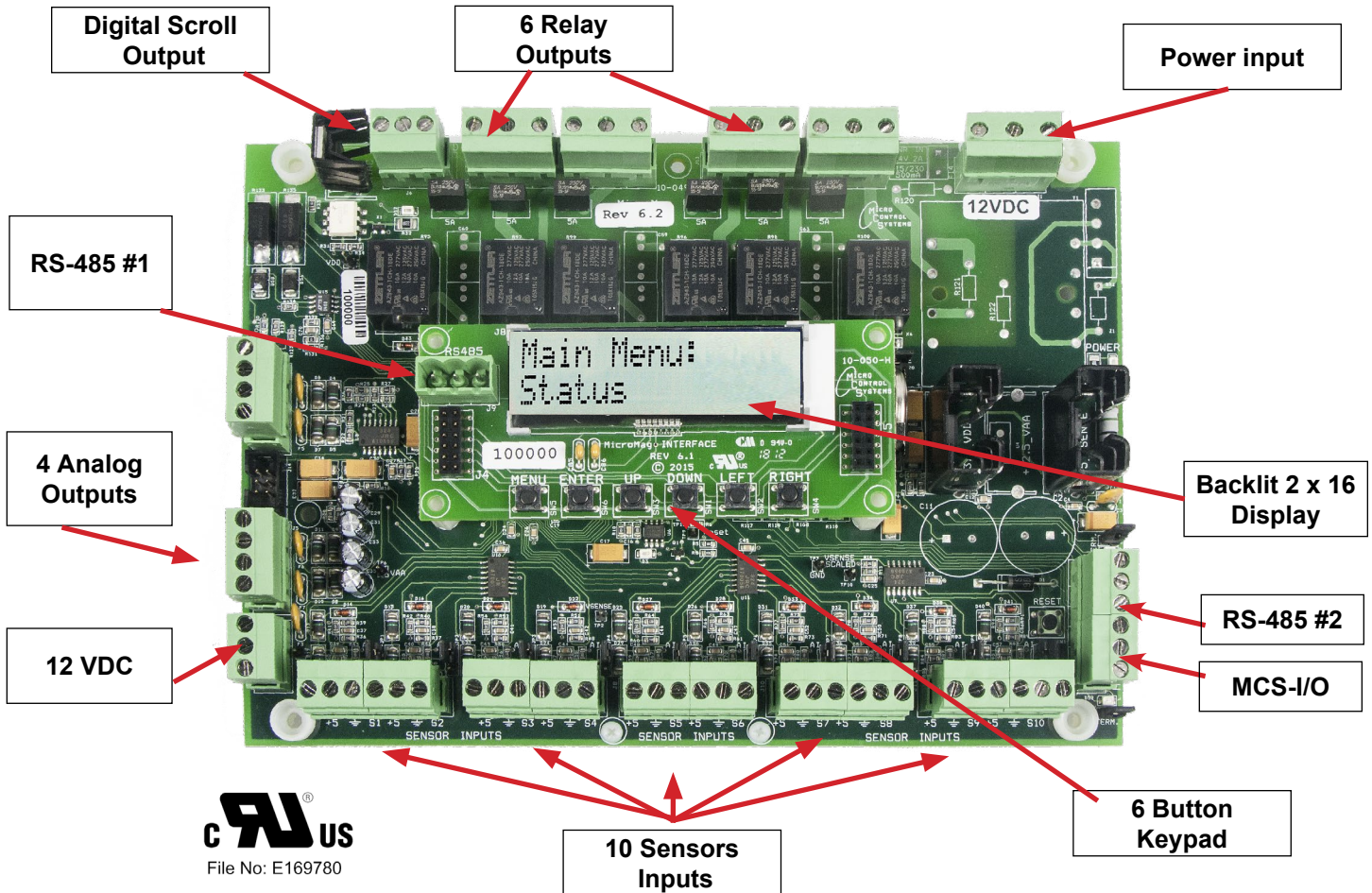

- Four Layer Printed Circuit Board with Power & Ground Plane for Noise Protection
- Six Relay Outputs, Fused @ 5 amps, Common & Normally Open Terminals Provided
- Ten Sensor Inputs (Analog or Digital) +5 VDC Power, Polyfuse Protected
- Four Analog Outputs provided, 0 to 10 VDC or 10 to 0 VDC, Polyfuse Protected
- +12 VDC provided for sensors where required, Polyfuse Protected
- Two RS 485 ports for BACnet MS/TP or Modbus RTU built in Communications
- MCS-I/O communications port to communicate to other I/O boards on this system
- A built in Boot Loader that allows MCS-CONNECT to load Firmware and Config's
- Program Flash = 512K, Aux Flash = 24K, Ram = 52K, DMA Ram = 4K, E² = 64K

1.2. MicroMag without Cover

Hardware Rev. 7.0 and greater - 12vdc

8.50”l, 6.00”w, 2.10”h

Operating Temp.-4°F to +158°F (-20°C to +70°C)

Sensor Inputs (SI).....10 inputs 0-5vdc (10-bit A/D)

Relay Outputs (RO)6 outputs 5. 0amps @ 24 vac

Analog Outputs (AO)4 outputs 0-10vdc

MCS-I/O Comm Port.....1 @ 38,400 baud

RS-485 Comm Port2 @ 19,200 to 115,200 baud

Real Time Clock.....Battery backed

Input power12vdc

Power DetectionAutomatic power fail reset

Keypad/LCD Display.....2 x 16 Backlit on I²C Bus

Keypad Layout.....6 keys (Menu, Enter, 4 direction)

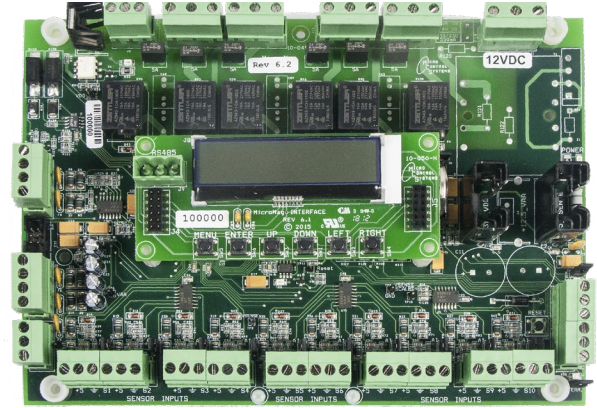

1.3. MicroMag with Cover

Comes with a Cover as shown in the photo on right. The cover is designed to mount on front of the circuit board or it can be mounted on the faceplate of your enclosure as shown below.

The LCD/Keypad is now REVERSIBLE.



1.4. MicroMag-12-Nema 4

The MicroMag-12-NEMA4 is suitable for installation, both indoor and outdoor. Utilizing a gasket for an environment seal provides the unit with a NEMA 4 rating if installed in a NEMA4 enclosure.



Chapter - 2. MicroMag Optional Expansion Boards

2.1. MCS-SI-BASE and MCS-SI-EXT

The MCS-SI-BASE provides a flexible and cost effective way to allow sensor input and analog output expansion for the MicroMag. Each MCS-SI-BASE has a stand-alone microprocessor which communicates with the MicroMag over the MCS-I/O port at 38,400 baud. Because communication is over a RS-485 long distance two-wire differential network transmission system, the MCS-SI-BASE may be located up to 5,000 feet away. The MCS-SI-BASE board is powered by a 12VDC regulated power supply and has a automatic power fail reset system.

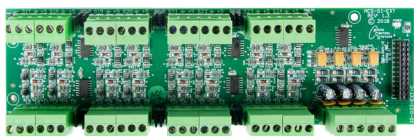
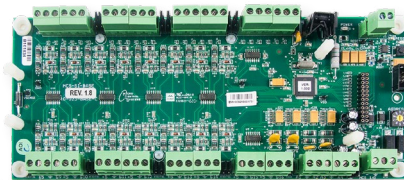

MCS-SI-EXT

MCS-SI-EXT can be paired with a MCS-SI-BASE to double the number of inputs and outputs. MCS-SI-EXT board is powered by the MCS-SI-BASE board once it is stacked on top.

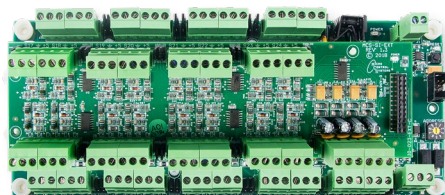

MCS-SI-EXT mounted to
MCS-SI-BASE

2.2. MCS-RO-BASE and MCS-RO-EXT

The MCS-RO-BASE allows relay output expansion for the MicroMag. Each MCS-RO-BASE has a stand-alone microprocessor which communicates with a MicroMag over the MCS-I/O port at 38,400 baud. The MCS-RO-BASE board is powered by a 12VDC regulated power supply.

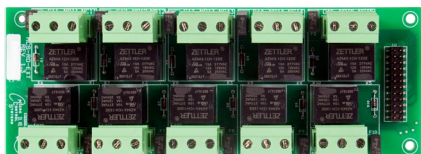
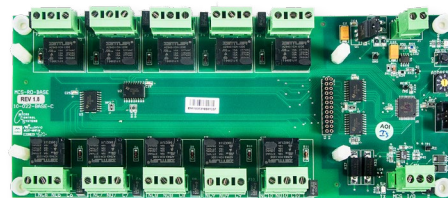

MCS-RO-EXT

MCS-RO-EXT can be paired with a MCS-RO-BASE to double the number of inputs and outputs. MCS-SI-EXT board is powered by the MCS-RO-BASE board once it is stacked on top.

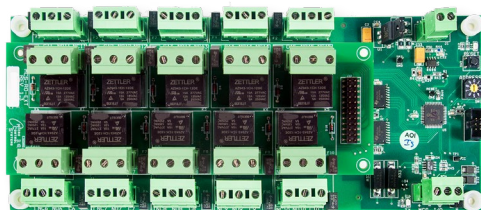

MCS-RO-EXT mounted to
MCS-RO-BASE



2.3. MCS-IO-BASE and MCS-IO-EXT

The MCS-IO-BASE can provide sixteen extra sensors inputs, 10 relay outputs and four additional analog outputs that provide independent DC voltage outputs from 0 to 10vdc. These analog outputs are controlled by the Micromag.

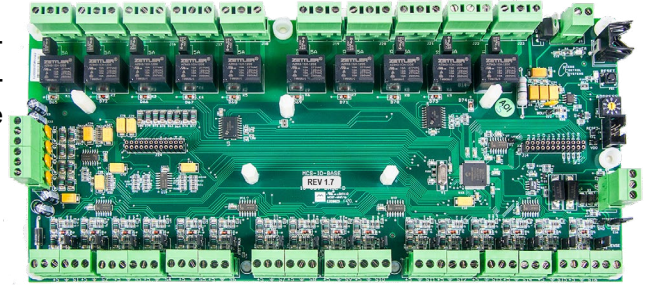

MCS-IO-EXT

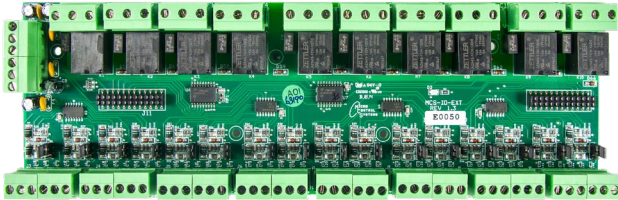

The MCS-IO-BASE allows one optional MCS-IO-EXT board to be stacked on top by using a board stacker header. Doing so will expand the number of sensors from 16 to 32, the number of analog outputs from 4 to 8, and the number of relays from 10 to 20 allowing twice the number of sensors, analog outputs, and relay outputs in the same footprint of one MCS-IO-BASE.

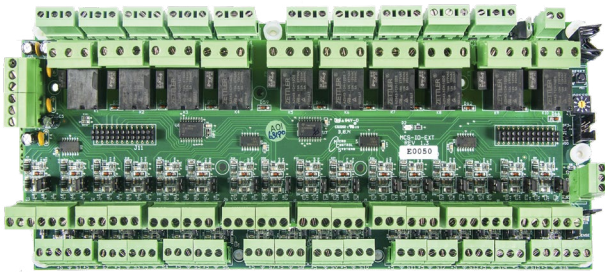

MCS-IO-EXT mounted to MCS-IO-BASE



Chapter - 3. AUTHORIZATION FUNCTION

The authorization code is a special four-character code that enables access to the MicroMag controller. The code may consist of any valid alpha/numeric characters if the system is being accessed through MCS-CONNECT, however, the code must be numeric with values between 0 and 9 if it is to be entered through the Keypad/Display. Each MicroMag can have up to 10 different authorization codes, with four levels of authorization which provide differing levels of functionality. The authorization code and the associated level cannot be viewed or changed through the Keypad/Display or MCS-CONNECT, but only when the configuration file is opened in MCS-Config. The authorization codes should be protected and remain confidential, or unauthorized personnel may gain access to the system and perhaps cause irreparable damage.

Based upon the authorization level the following changes can be made through the Keypad/Display:

FUNCTION	VIEW	USER	SERVICE	SUPERVISOR	FACTORY	ADMIN
Sensor offsets	NO	NO	NO	YES	YES	YES
Clear alarm history	NO	NO	NO	NO	NO	YES
Clear point information	NO	NO	NO	NO	NO	YES
Date and time set	NO	NO	YES	YES	YES	YES
Day of week set	NO	NO	YES	YES	YES	YES
Change rotate SP 37 & 38	NO	NO	YES	YES	YES	YES
Change Manual/Auto settings	NO	NO	NO	YES	YES	YES
Change Setpoint values	*	*	*	*	YES	YES
Change operating schedules	NO	YES	YES	YES	YES	YES
Change holiday dates	NO	YES	YES	YES	YES	YES
Lockout Reset	**	**	**	**	YES	YES
Change RS485 network settings	NO	NO	NO	YES	YES	YES
Change Ethernet network settings	NO	YES	YES	YES	YES	YES
Transmit Software	NO	YES	YES	YES	YES	YES
Transmit/Receive Configuration	NO	NO	YES	YES	YES	YES

* Setpoints may have individual authorization levels; you must have the proper authorization to view or edit them.

**See the Setup screen of the configuration for authorization level(s) that are allowed unlimited resets per day.

Authorization passwords with level below 'Auth Level Bypass' are allowed only a limited number of resets.

Authorization passwords with level at and above 'Auth Level Bypass' are allowed unlimited lockout resets.

The image shows a configuration window with two settings:

- Max Lockout Resets per Day:** A dropdown menu currently showing the value '6'.
- Auth Level Bypass:** A dropdown menu currently showing the value 'Supervisor Level'.

3.1. Authorized via the Keypad/LCD

Press 'Menu' - Use UP↑ to scroll to Password option

Press 'ENTER↵' key.

Using 'UP↑, DOWN↓', keys, to select/scroll number, press **Right key** → to move to next number

Press 'ENTER ↵' key to accept.

The authorization level will be displayed if a valid pin number is entered.



3.2. Authorized via MCS-CONNECT

1. Click on desired MicroMag in the Site Information screen.

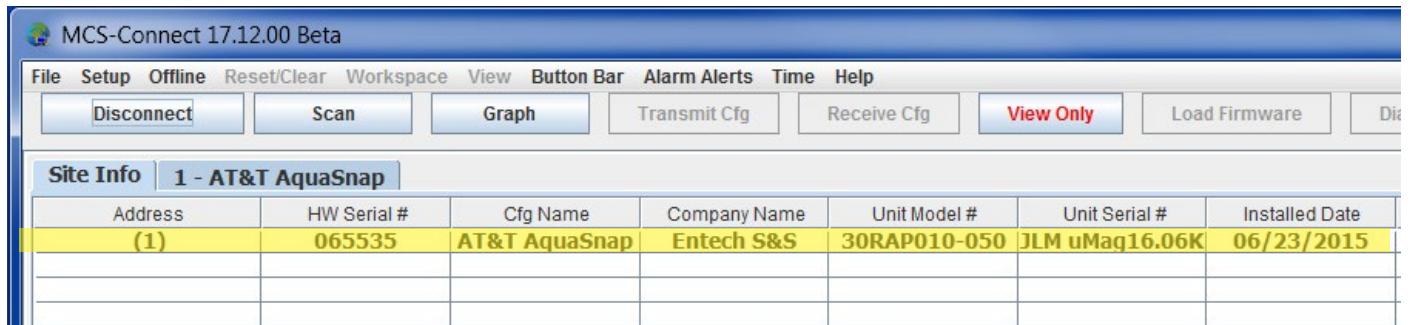

2. Click button 'VIEW ONLY' to get authorized to a higher level.

3. Enter the 4 digit password into the pop-up box and click ok (or press the enter key).

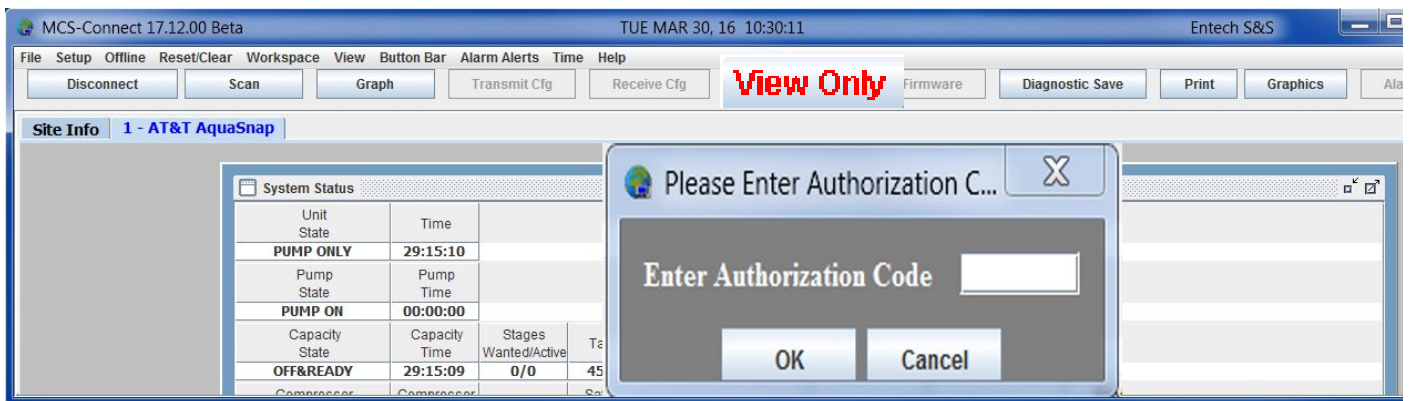

4. Depending on the authorization level, the button will change to one of the following displays, indicating if the password was accepted and what level.



Chapter - 4. MicroMag Keypad

4.1. Main Menu Status

Main Menu Status

'DOWN ↓ or UP ↑' buttons moves thru the MENU

- Outputs - RO's, AO's, Inputs - SI's, Service Tools, Setpoints,
- Alarms /Events. Lockouts -Clear, Enter Password

'MENU' button moves back to Main Menu Status display

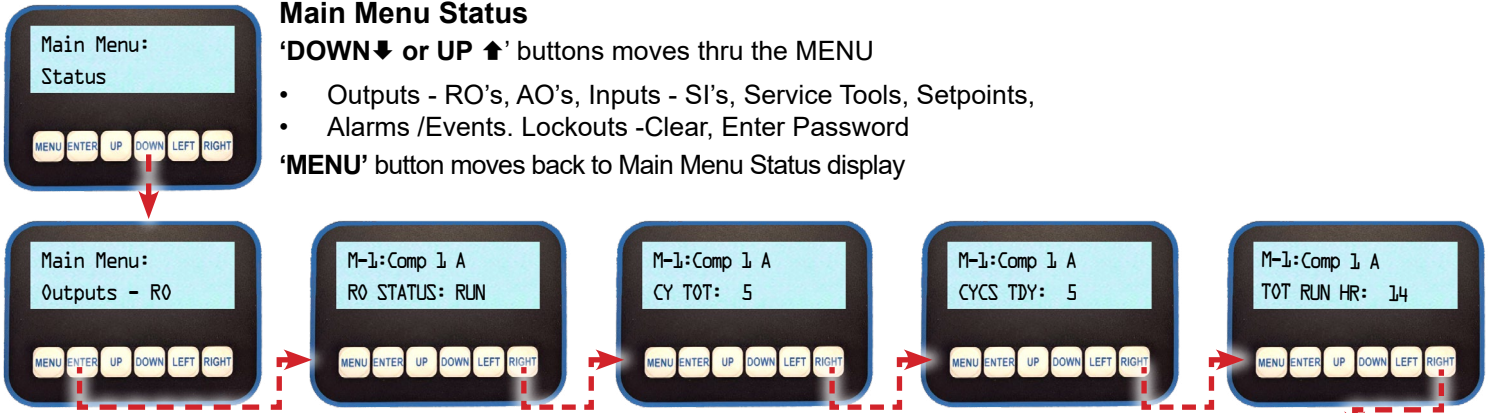

'MENU' button moves back to Main Menu Status display

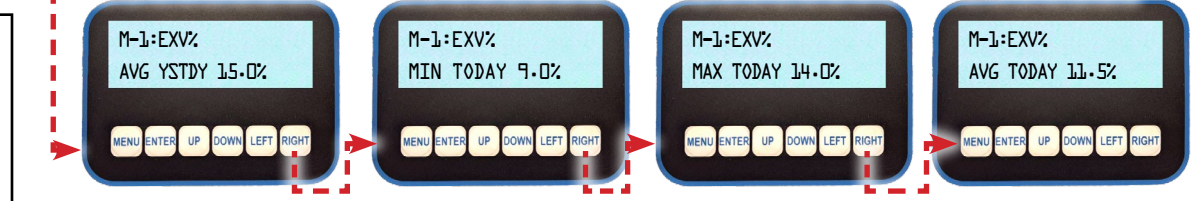

'MENU' button moves back to Main Menu Status display

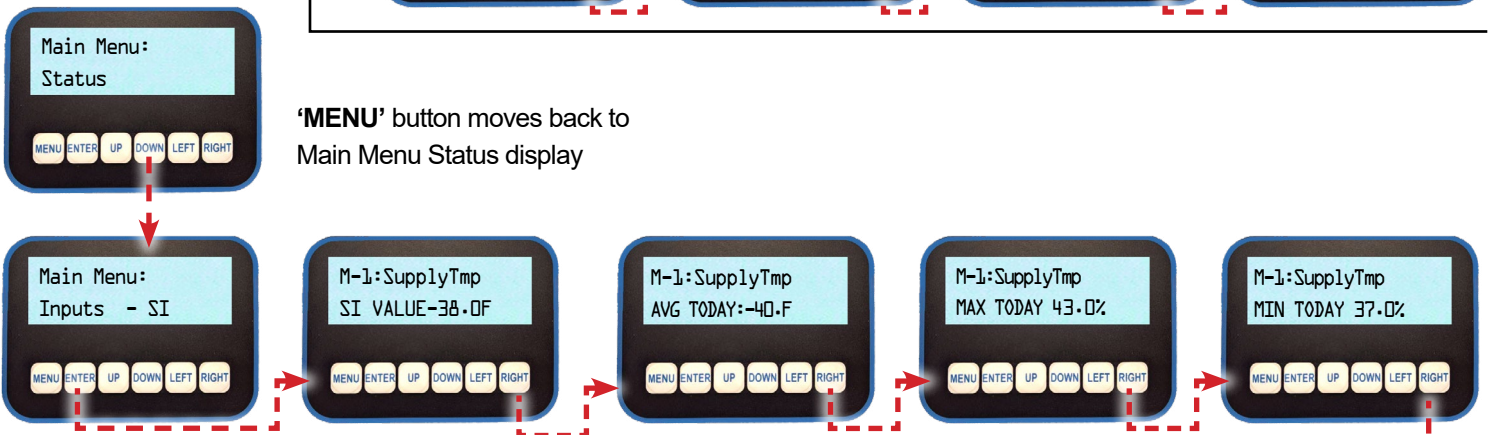

'DOWN ↓' button moves thru current SIs in configuration setup
RIGHT → button shows MIN/MAG/AVG values



4.2. Service Tools

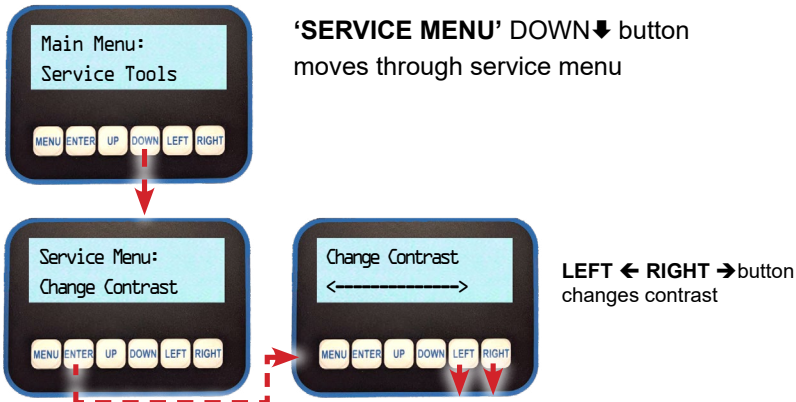
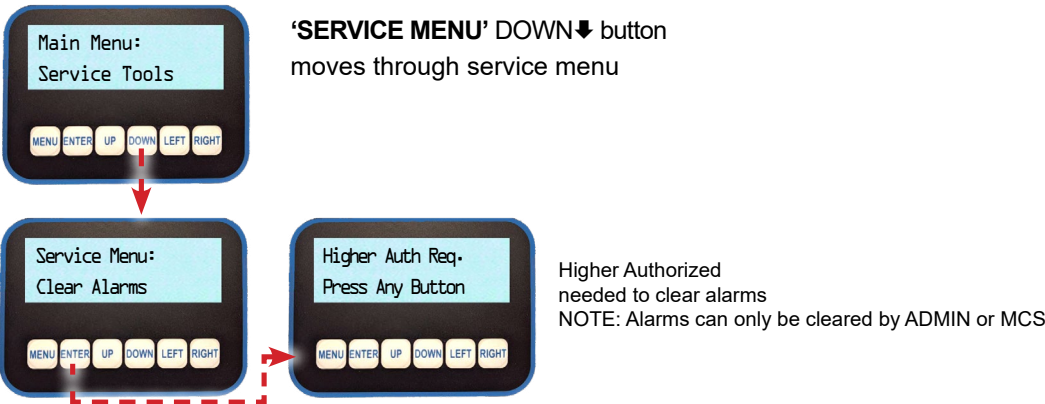
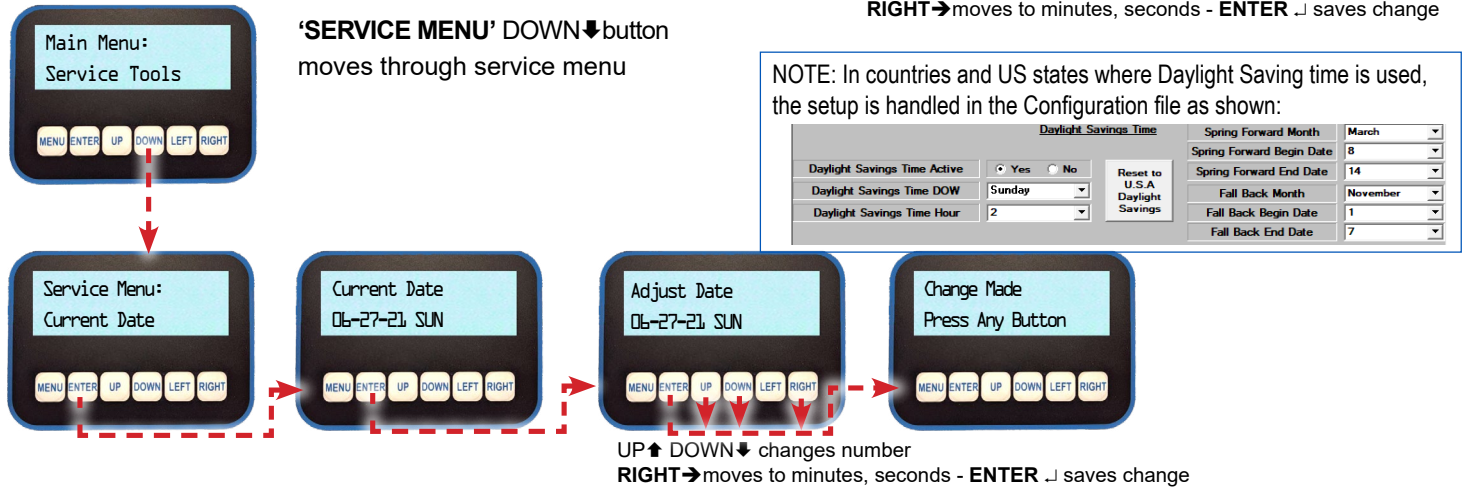
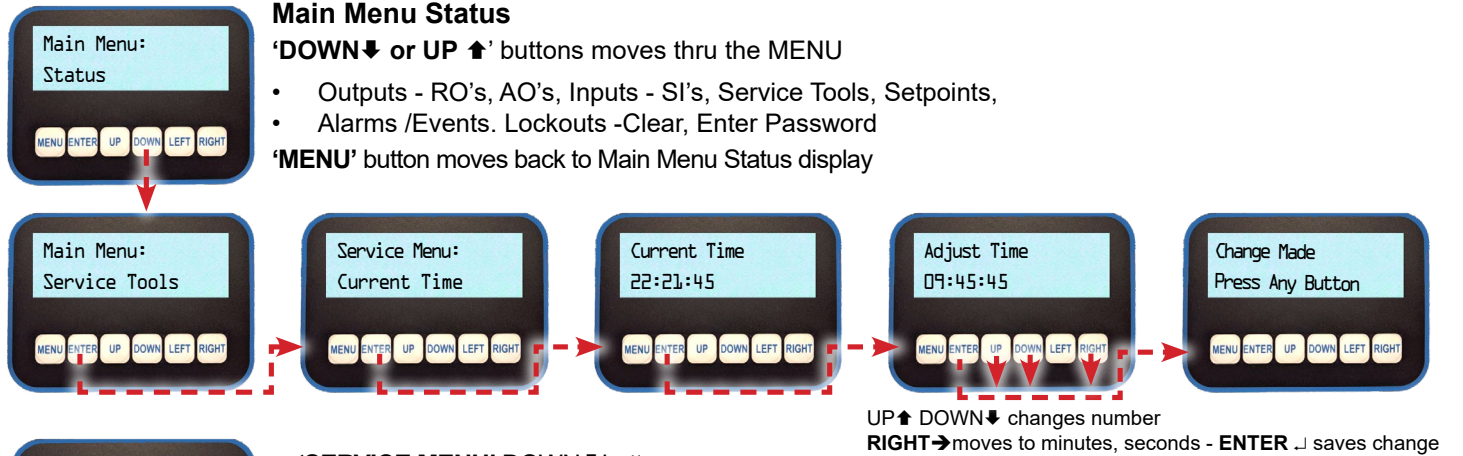



'SERVICE MENU' DOWN↓ button moves through service menu



Addresses available
• 1 to 250

Press DOWN↓ to change address
ENTER ↵ saves change - Press any button to continue



'SERVICE MENU' DOWN↓ button moves through service menu

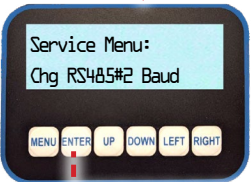

Available Baud Rates
• 19200
• 38400
• 57600
• 115200

Press DOWN↓ to change Baud rate
ENTER ↵ saves change

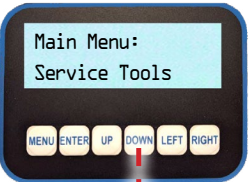

'SERVICE MENU' DOWN↓ button moves through service menu

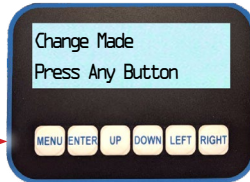

Available Protocols
• MCS Protocol
• Modbus RTU
• BACnet Protocol

Press DOWN↓ to change Protocol
ENTER ↵ saves change



'SERVICE MENU' DOWN↓ button moves through service menu

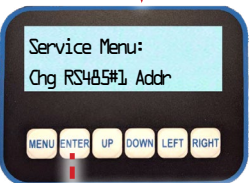

Addresses available
• 1 to 250

Press DOWN↓ to change Protocol
ENTER ↵ saves change

SERVICE TOOLS

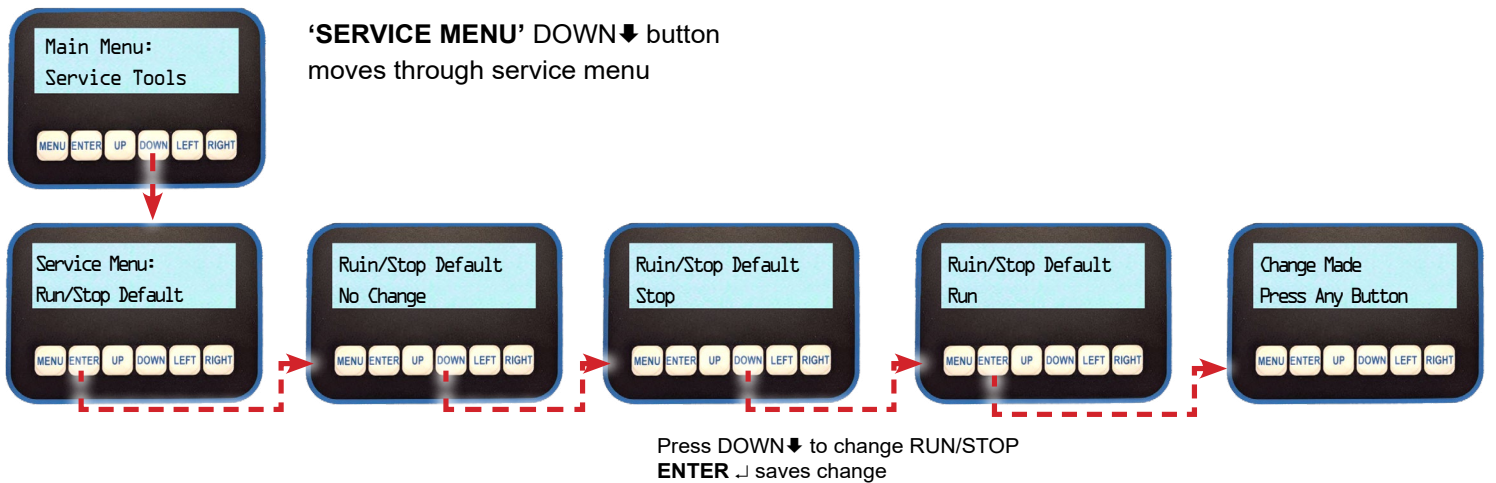
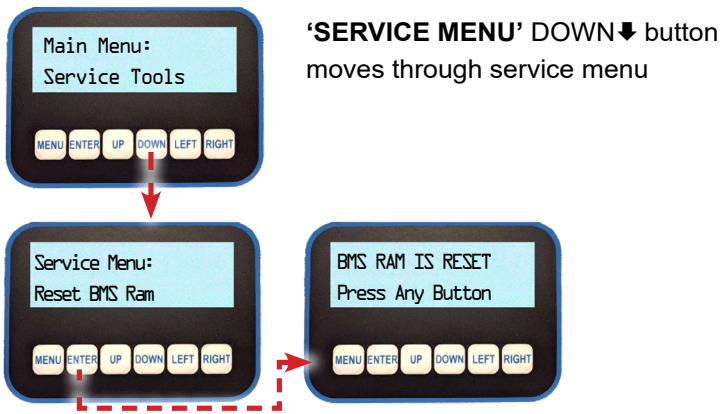
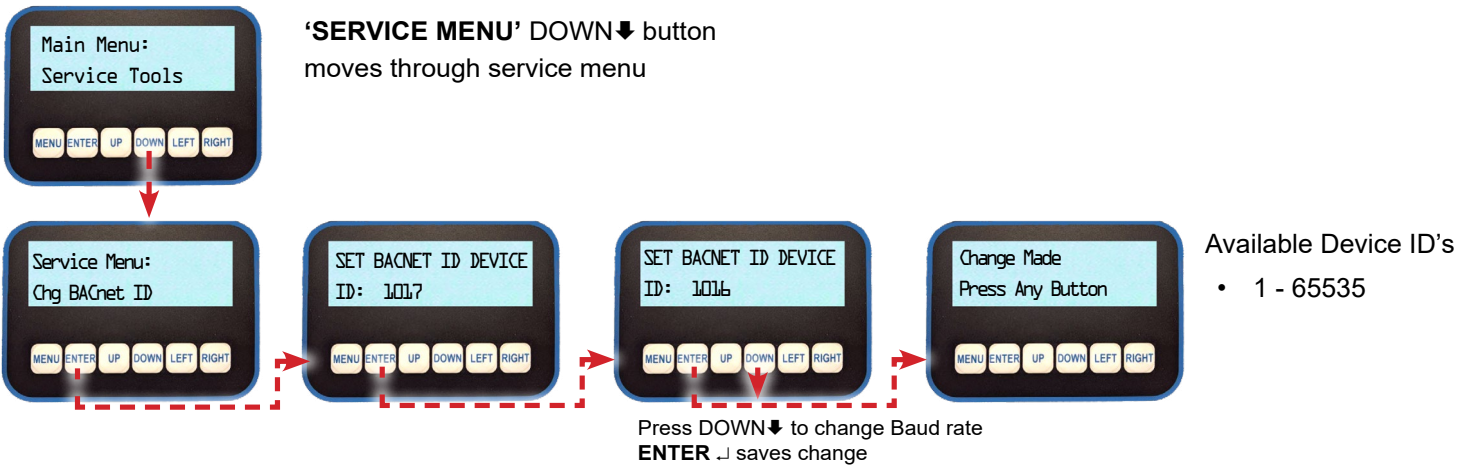
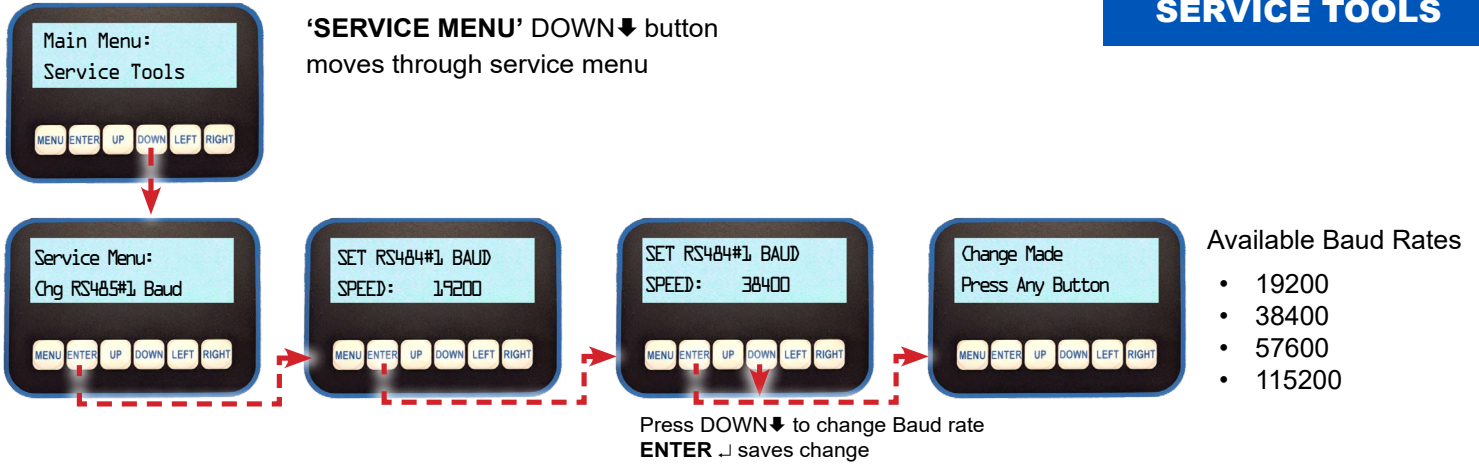

SERVICE TOOLS

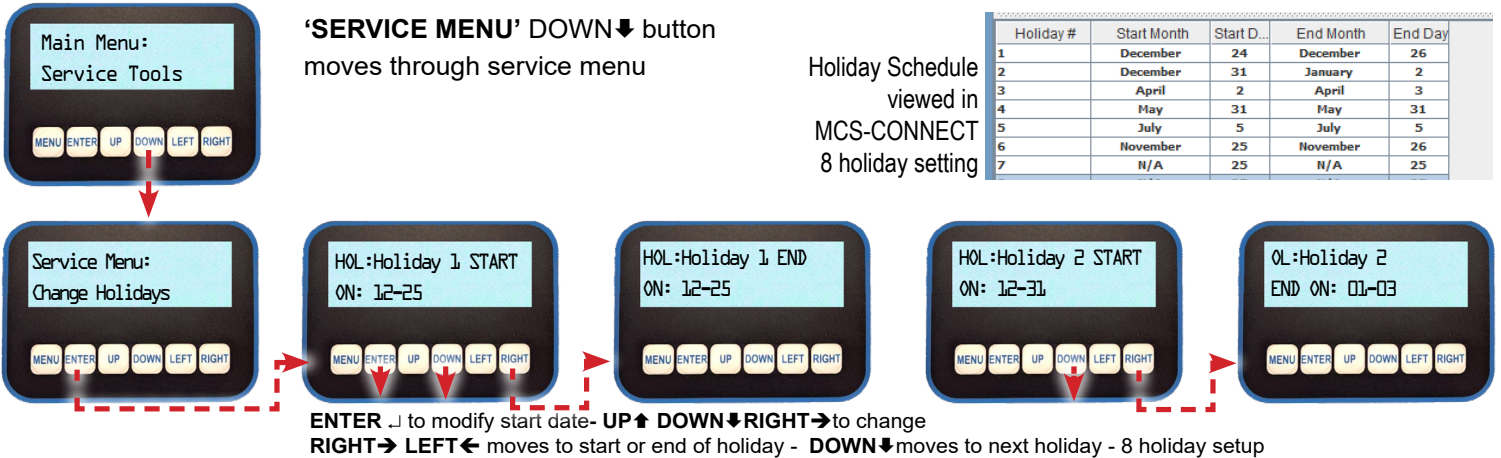
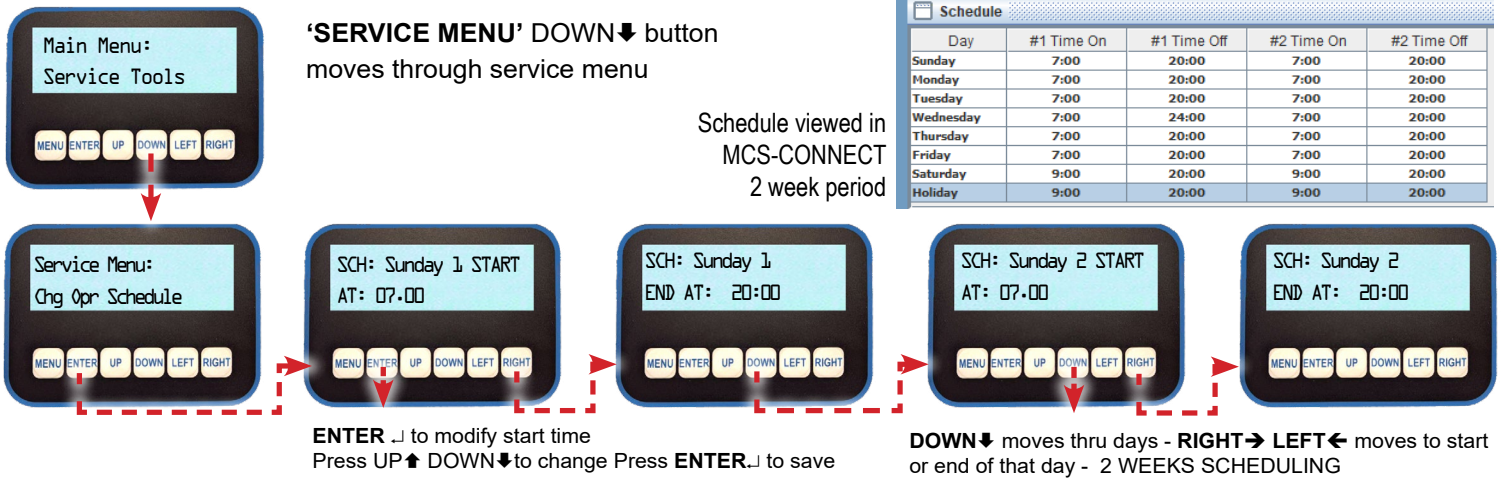
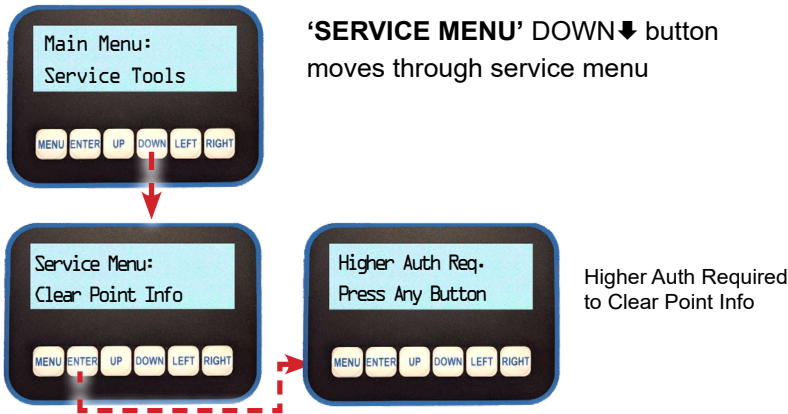
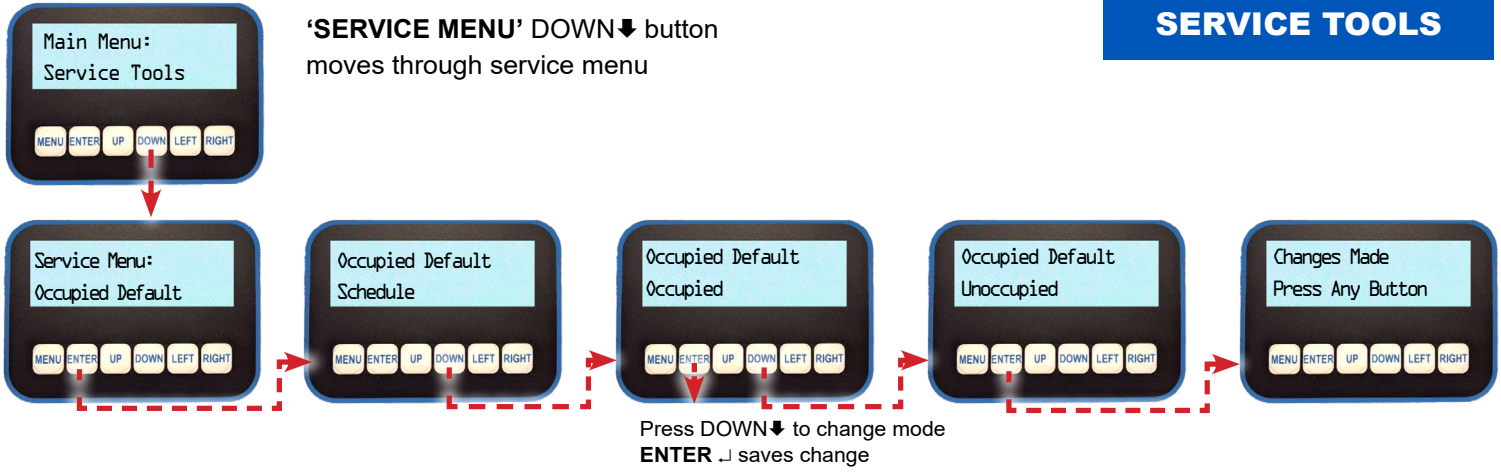

4.3. Viewing Alarms And Events

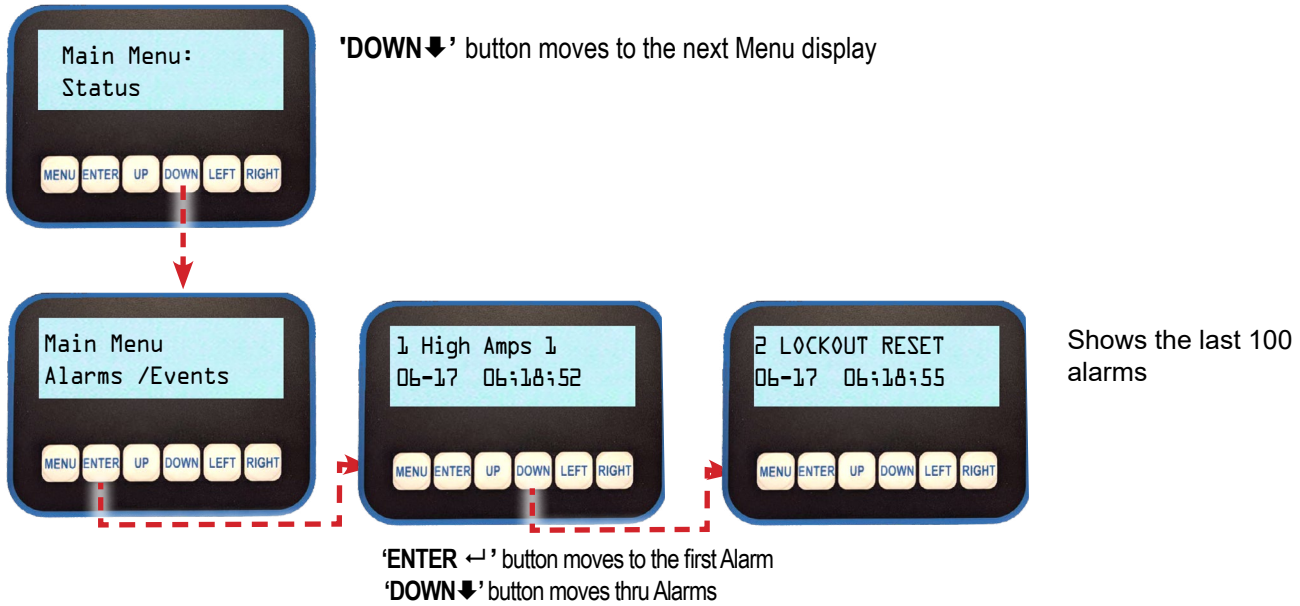

4.4. Lockout - Clear

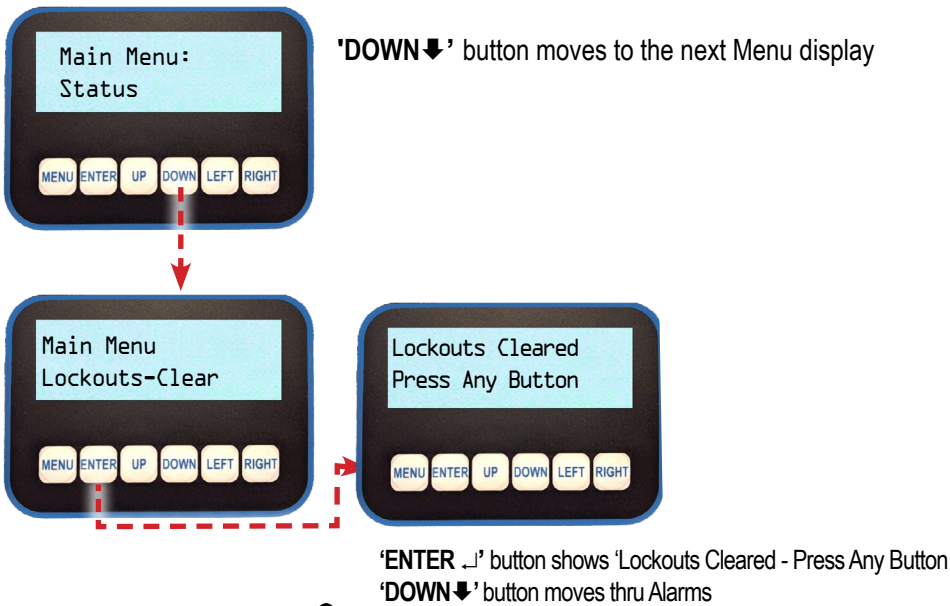

Lockout Reset requires Factory Level Authorization or higher

Max Lockout Resets per day - 6

Authorization levels below 'Auth Level Bypass' are allowed only a limited number of resets.

Authorization levels at and above 'Auth Level Bypass' are allowed unlimited lockout resets.

4.5. Changing Values of a Setpoint

NOTE: Additional changes can be made to a setpoint by pressing **RIGHT** button and moving thru the different value settings

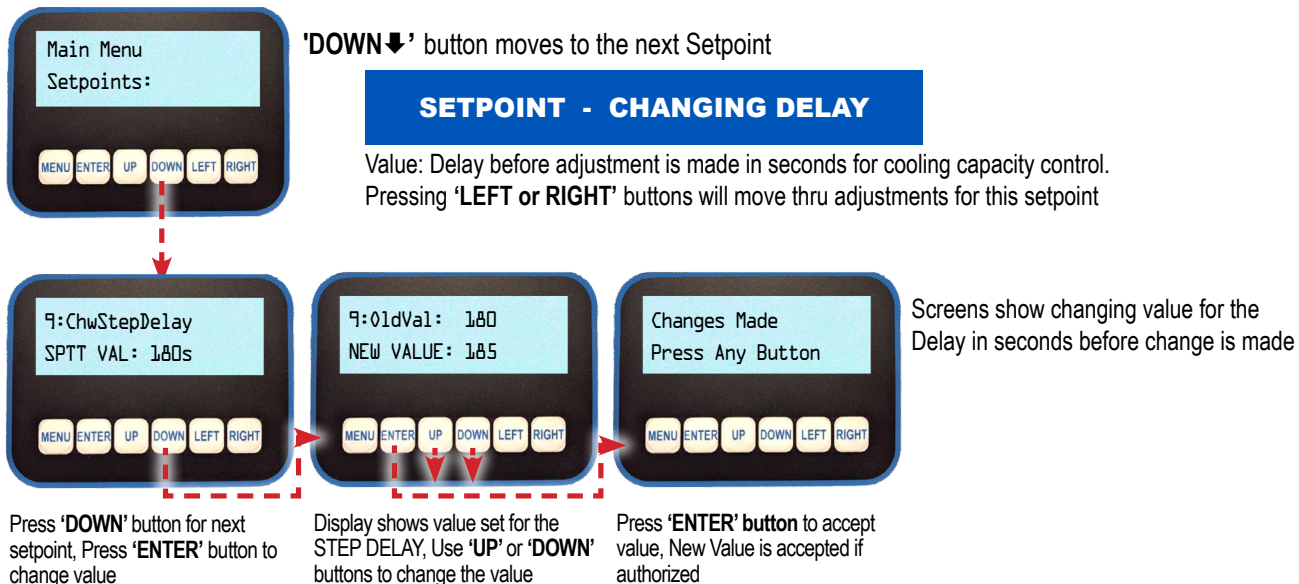
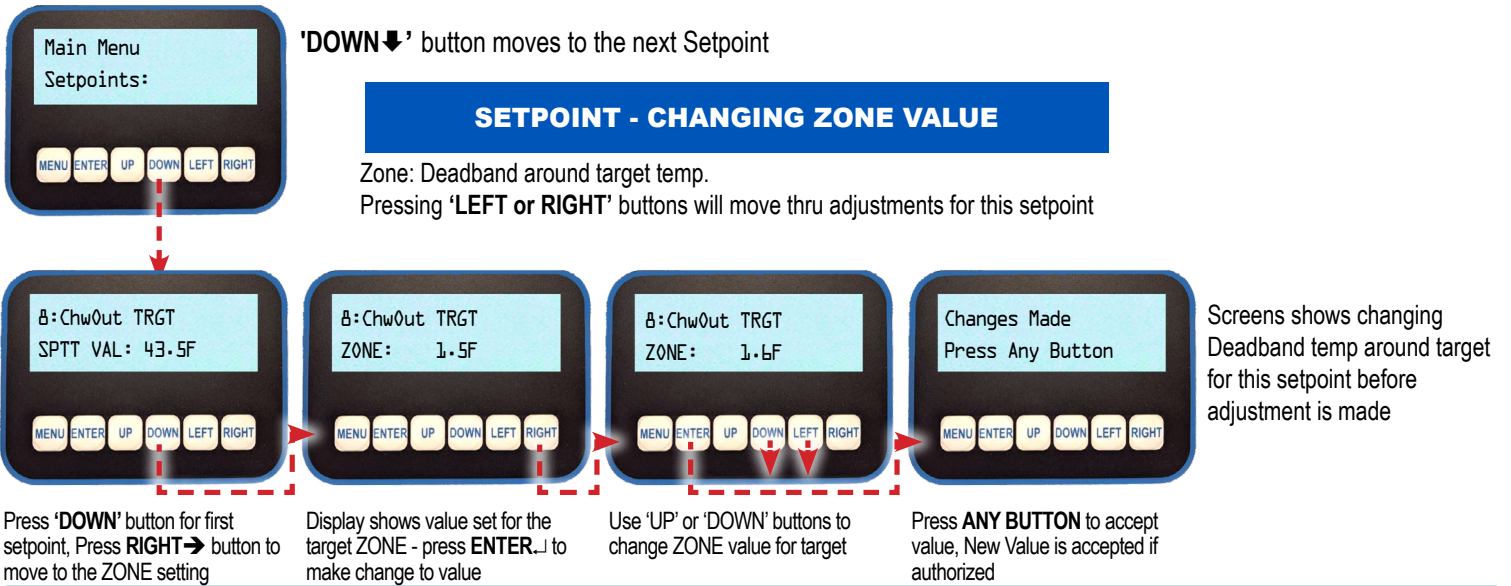
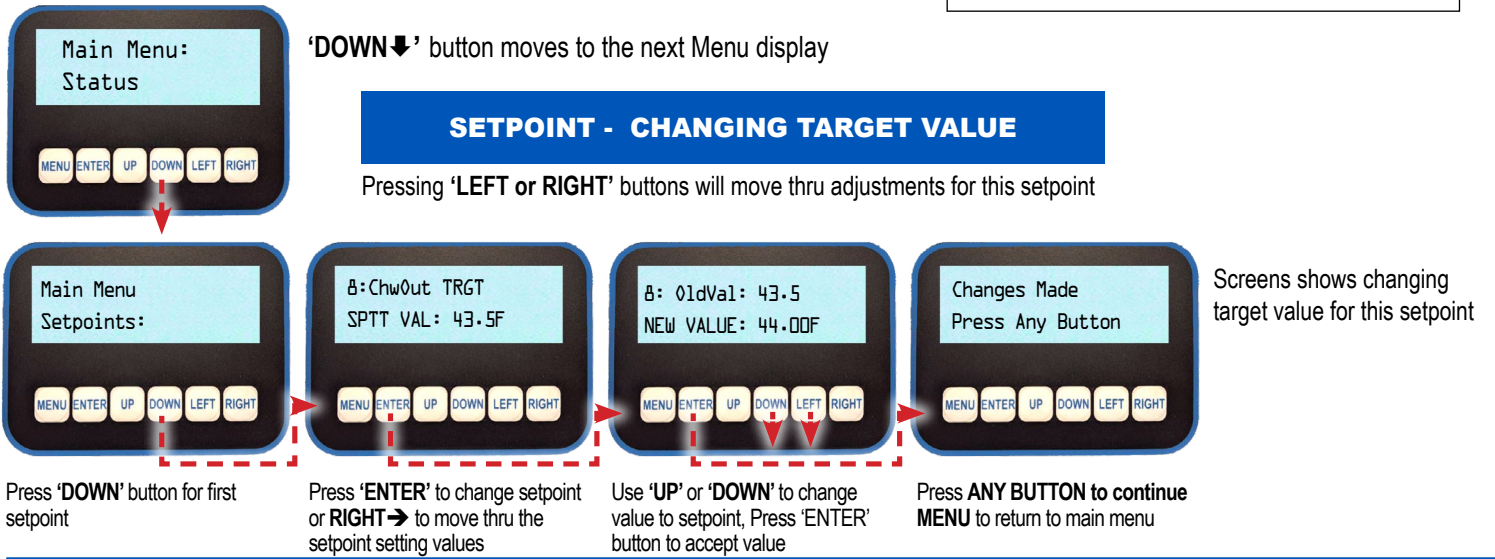

4.6. Viewing the Current Status of the Unit

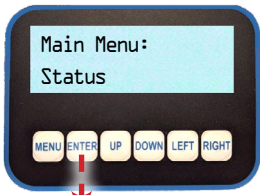

Main Menu Status

'DOWN ↓ or UP ↑' buttons moves thru the MENU

- Outputs - RO's, AO's, Inputs - SI's, Service Tools, Setpoints,
- Alarms /Events. Lockouts -Clear, Enter Password

'MENU' button moves back to Main Menu Status display

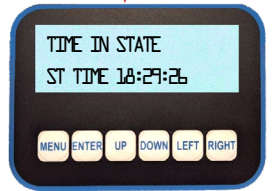
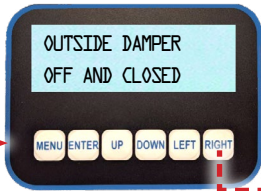

Chapter - 5. MicroMag Communications Options

5.1. MicroMag's using MCS-CONNECT - MCS-USB-RS485

- Using MCS-USB-RS485 cable, connect Laptop to either RS485 terminal #1 or #2 as shown.
- Open MCS-CONNECT, click on Serial and scan for MicroMag(s).

Site Info		1 - 2COMP/2CKT							
Address	HW Serial #	Cfg Name	Company Name	Unit Model #	Unit Serial #	Installed Date	Cfg Vers	Firmware Vers	Cfg Date
(1)	065535	2COMP/2CKT	SKM,SHARJ...	APMR-6201...	AS0000149-...	07/19/2020	18	SKM 18.000e	06/04/2021

- Select tab for a unit to see details of that MicroMag

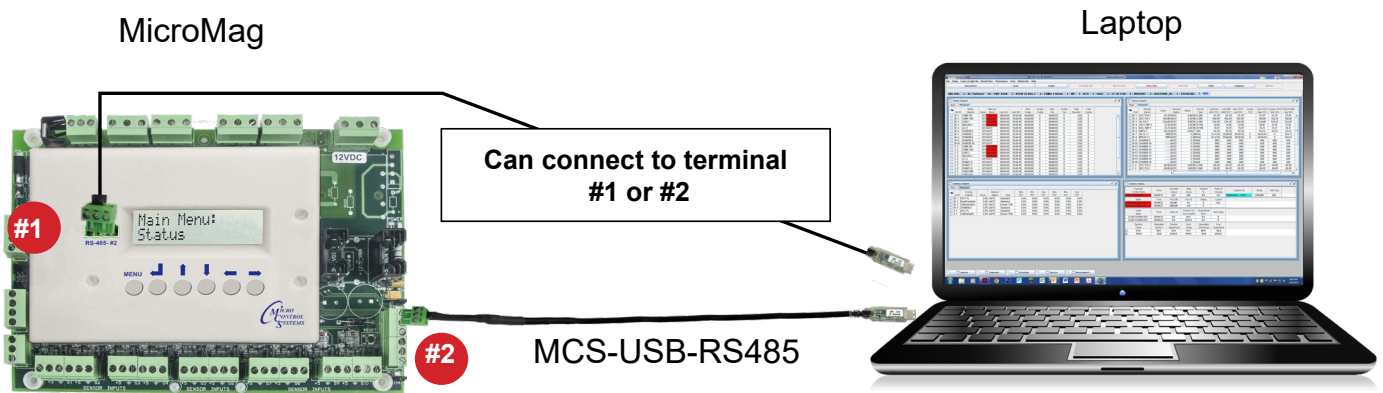

5.2. Multiple MicroMag's using MCS-CONNECT - RS485 and MCS-Touchscreen

- Uses MicroMag RS-485 #2 communications terminal
- Two wire shielded cable wired in straight line (NO STAR)
- Open MCS-CONNECT, click on Serial and scan for MicroMag(s)
- Select tab of MicroMag you want to view.

File Setup Offline Reset/Clear Workspace View Button Bar Time Help Live Graph Extended History - Enable ALARM ALERTS-INACTIVE Analysis																					
Disconnect		Scan		Graph		Transmit Cfg		Receive Cfg		View Only		Load Firmware		Diagnostic Save		Print		Graphics		Alarms	
Site Info 1 - 2COMP/2CKT																					
Address	HW Serial #	Cfg Name	Company Name	Unit Model #	Unit Serial #	Installed Date	Cfg Vers.	Firmware Vers.	Cfg Date												
(1)	065535	2COMP/2CKT	SKM,SHARJ...	APMR-6201...	AS0000149-...	07/19/2020	18	SKM 18.00Oe	06/04/2021												
(2)	065535	2COMP/2CKT	SKM,SHARJ...	APMR-6201...	AS0000149-...	07/19/2020	18	SKM 18.00Oe	06/04/2021												
(3)	065535	2COMP/2CKT	SKM,SHARJ...	APMR-6201...	AS0000149-...	07/19/2020	18	SKM 18.00Oe	06/04/2021												
(4)	065535	2COMP/2CKT	SKM,SHARJ...	APMR-6201...	AS0000149-...	07/19/2020	18	SKM 18.00Oe	06/04/2021												

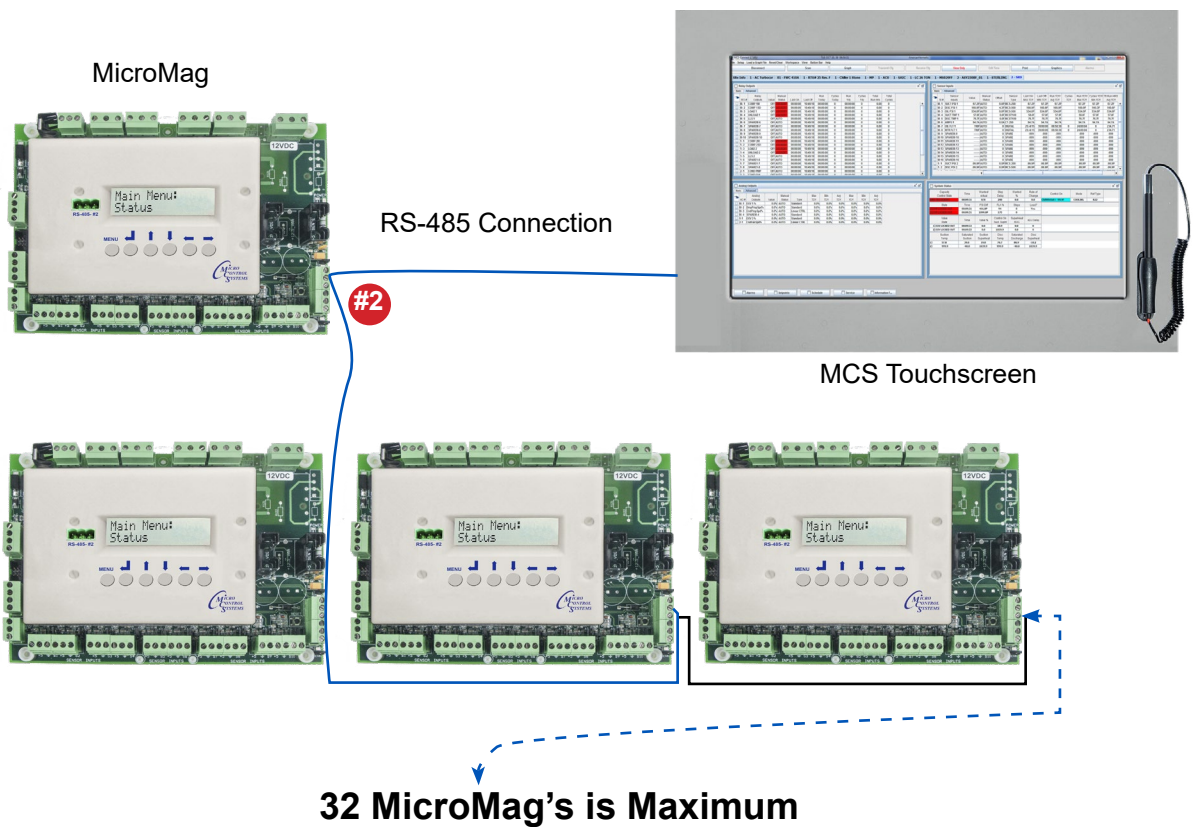

5.3. Multiple MicroMag's, over Internet using MCS-Connect & MCS-ETHERNET-RS485

- MCS-Connect maximum is 32 MicroMag's
- Uses MicroMag RS-485 #2 communications terminal
- Two wire shielded cable wired in straight line (NO STAR)
- At either end of RS-485 network install MCS-ETHERNET-RS485 to convert to Ethernet
- Connect to MCS-Ethernet-RS485 using MCS-Connect via IP Address
- Select the tab of MicroMag you want to view

File Setup Offline Reset/Clear Workspace View Button Bar Time Help Live Graph Extended History - Enable ALARM ALERTS-INACTIVE Analysis																					
Disconnect		Scan		Graph		Transmit Cfg		Receive Cfg		View Only		Load Firmware		Diagnostic Save		Print		Graphics		Alarms	
Site Info										1 - 2COMP/2CKT											
Address	HW Serial #	Cfg Name	Company Name	Unit Model #	Unit Serial #	Installed Date	Cfg Vers.	Firmware Vers.	Cfg Date												
(1)	065535	2COMP/2CKT	SKM,SHARJ...	APMR-6201...	AS0000149-...	07/19/2020	18	SKM 18.00Oe	06/04/2021												
(2)	065535	2COMP/2CKT	SKM,SHARJ...	APMR-6201...	AS0000149-...	07/19/2020	18	SKM 18.00Oe	06/04/2021												

- Select tab for a unit to see details of that MicroMag

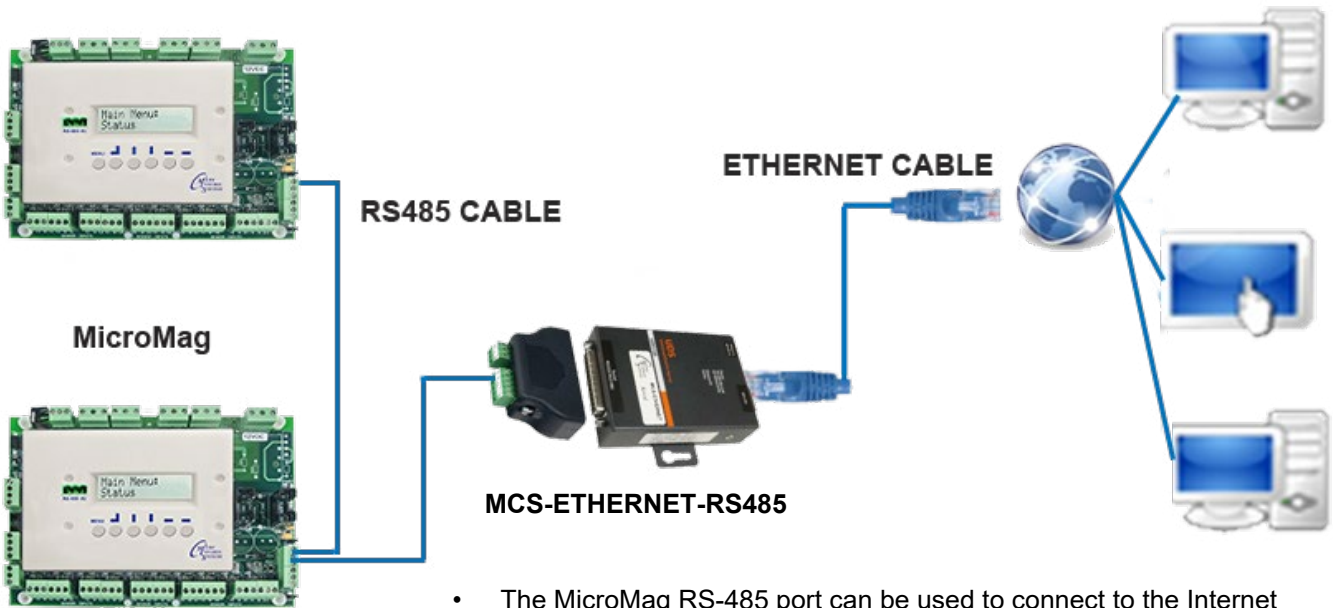

- The MicroMag RS-485 port can be used to connect to the Internet using a MCS-ETHERNET-RS485 and internet static IP address

Chapter - 6. MCS-CONNECT Software Support

MCS-Connect provides both local and remote communications to the MicroMag independent of software type. Local communications is through an RS 485 connection. This program displays the status of the

controller, and changes can be made to the system with proper authorization. Configuration files can be transmitted to or received from a MicroMag unit. The MicroMag automatically performs history logging and this program allows the data to be presented in a useful graph form.

Requirements for PC Software

To install and run the MCS-Connect program we suggest the following system requirements:

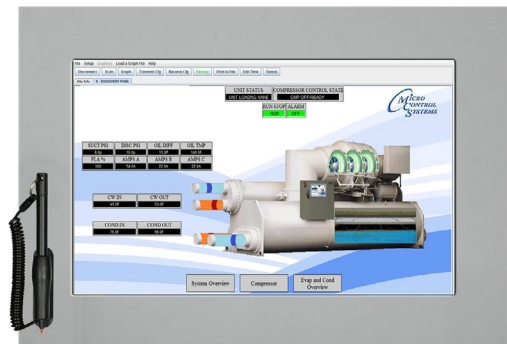

Minimum System Required to Run Program

- PC with a Pentium2-class or higher processor or MCS TOUCHSCREEN - 10.1" or 15.4"
- Windows 7 or MCS-Linux
- Minimum 1GB of RAM
- Minimum 4GB Drive
- 1280 x 800 pixel or higher display
- Ethernet 10m/100m/1000
- USB port 2.0 or higher

Chapter - 7. MCS-CONNECT Screens

7.1. MicroMag STATUS

The screenshot displays the MCS-CONNECT MicroMag STATUS interface. At the top, a menu bar includes options like File, Setup, Offline, Reset, Clear, Workspace, View, Button Bar, Alarm Alerts, Time, and Help. Below the menu bar is a row of tabs: Disconnect, Scan, Graph, Transmit Cfg, Receive Cfg, Factory, Load Firmware, Diagnostic Save, Print, Graphics, and Alarms. The main interface is divided into several sections:

- Relay Outputs:** A table showing relay status for various components like COMP 1, COMP 2, COMP 3, COMP 4, CND FAN 1, CND FAN 2, WARNING, and ALARM. Columns include RO #, Relay Outputs, Value, Manual Status, Last On, Last Off, Run Today, Cycles Today, Run Ydy, Cycles Ydy, Total Run Hrs, and Total Cycles.
- Sensor Inputs:** A table showing sensor status for various inputs like ChwIn Temp, ChwOutTemp, SUCT 1 PSI, DISC 1 PSI, SUCT 1 TMP, DISC 2 TMP, PUMP DOWN1, CMP 1 AMPS, CMP 2 AMPS, SUCT 2 PSI, DISC 2 PSI, SUCT 3 TMP, DISC 4 TMP, PUMP DOWN2, and CMP 3 AMPS. Columns include SI #, Sensor Inputs, Value, Manual Status, Offset, Sensor Type, Last On/ MAX TDY, Last Off/ MIN TDY, Run TDY/ Avg TDY, Cycles TDY, and Run YDY/ Max YDY.
- Analog Outputs:** A table showing analog output status for TRIC SPARE, EXV 1 POS, and EXV 2 POS. Columns include AO #, Analog Outputs, Value, Manual Status, Type, Max TDY, Min TDY, Avg TDY, Max YDY, Min YDY, and Avg YDY.
- System Status:** A detailed view of the system's operational state, including Unit State, Time, Pump Only status, Pump Time, Pump On status, Capacity State, Capacity Time, Stages Wanted/Active, Target, Control On, Wanted %, ADJ Delay, Rate of Change, Compressor State, Compressor Time, FLA %, Saturated Suction, Suction Superheat, Saturated Condenser, Disc Superheat, Oil Differential, Lead?, EXV State, EXV Time, Valve %, Control On Suct. Supht, SuperHeat ROC, ADJ Delay, EXV CLOSED, EXV CLOSED, Condenser State, Condenser Time, Stages Wanted/Active, Target, Control On, Wanted %, ADJ Delay, Rate of Change, and COND OFF.

Callouts in the image point to the following features:

- Available Site Tabs:** Points to the top row of tabs.
- Relay Outputs:** Points to the Relay Outputs table.
- Sensor Inputs:** Points to the Sensor Inputs table.
- Analog Outputs:** Points to the Analog Outputs table.
- Selection Tabs:** Points to the bottom row of tabs (Schedule, Service, Information F..., Alarms, Setpoints).
- Control Status:** Points to the System Status section.

The screen shot above shows the following features:

- Across the top is a row of tabs. The first is the Site Information screen which will show you details of all the MCS controllers available to establish a connection. The remaining tabs allow you to access each unit one by one respectively.
- There are four quadrants of information displayed for each MCS controller, namely: Relay Outputs, Analog Outputs, Sensor Inputs, and Unit Status (with six sub-menus of Status, Alarms, Setpoints, Reset/Clear, Schedule, and Service). Note: these screens may not always be displayed in the same position; MCS-Connect will automatically adjust the screen arrangement for optimum

display information.

7.2. MicroMag RELAY OUTPUTS

The screenshot shows the 'Relay Outputs' window with the following data table:

RO #	Relay Outputs	Value	Manual Status	Last On	Last Off	Run Today	Cycles Today	Run Ydy	Cycles Ydy	Total Run Hrs	Total Cycles
<input type="checkbox"/>	M - 1 COMP 1	OFF	AUTO	11:29:15	11:29:15	00:00:00	0	00:00:00	0	0.00	0
<input type="checkbox"/>	M - 2 COMP 2	OFF	AUTO	11:29:15	11:29:15	00:00:00	0	00:00:00	0	0.00	0
<input type="checkbox"/>	M - 3 COMP 3	OFF	AUTO	11:29:15	11:29:15	00:00:00	0	00:00:00	0	0.00	0
<input type="checkbox"/>	M - 4 COMP 4	OFF	AUTO	11:29:15	11:29:15	00:00:00	0	00:00:00	0	0.00	0
<input type="checkbox"/>	1 - 1 CND FAN 1	OFF	AUTO	11:29:15	11:29:15	00:00:00	0	00:00:00	0	0.00	0
<input type="checkbox"/>	1 - 2 CND FAN 2	OFF	AUTO	11:29:15	11:29:15	15:00:00	1	00:00:00	0	297.47	19
<input type="checkbox"/>	1 - 5 WARNING	OFF	AUTO	11:29:15	11:29:15	00:00:00	0	00:00:00	0	0.00	0

Callouts in the image point to: RO Number, RO Names, RO Value, RO Status, Last On/Off, Run Hrs (Today, Yesterday, Total), and Cycles (Today, Yesterday, Total).

The screen shot above shows the following features:

- **RO Number** – Relay's M-1 is on and 1-1 is on.
- **RO Names** – Are up to 10 character and selected by the OEM for each output.
- **RO Value** – Can be On or Off.
- **RO Status** – Can be Auto, Manual or Locked off.
- **Last On/Off** – Last time turned on and off.
- **Run Hrs Tdy, Ydy, Total** – Run hours for Today, Yesterday and Total.
- **Cycles Tdy, Ydy, Total** – Cycles for Today, Yesterday and Total.

7.3. MicroMag ANALOG OUTPUTS

The screenshot shows the 'Analog Outputs' window with the following data table:

AO #	Analog Outputs	Value	Manual Status	Type	Max TDY	Min TDY	Avg TDY	Max YDY	Min YDY	Avg YDY
<input type="checkbox"/>	M - T TRIAC SPARE	0.0%	AUTO	Standard	0.0%	0.0%	0.0%	0.0%	0.0%	0.0%
<input type="checkbox"/>	M - 1 EXV 1 POS	0.0%	AUTO	Standard	0.0%	0.0%	0.0%	0.0%	0.0%	0.0%
<input type="checkbox"/>	M - 2 EXV 2 POS	0.0%	AUTO	Standard	0.0%	0.0%	0.0%	0.0%	0.0%	0.0%

Callouts in the image point to: AO Number, AO Names, AO Value, AO Status, Std or Inverted, Today (Max/Min/Avg) Today, and Yesterday (Max/Min/Avg).

The screen shot above shows the following features:

- **AO Number** – M-T is on MicroMag, it is a triac output for a digital scroll compressor.
- **AO Number** – M-1 is the first analog output on the MicroMag.
- **AO Names** – A 10 character selected by the OEM for each output.
- **AO Value** – The current analog output value. (0 to 10 VDC or 10 to 0 VDC)
- **AO Status** – Auto or Manual.
- **AO Type** – Can be standard, inverted.

- Min/Max & Avg – For today and yesterday.

7.4. MicroMag SENSOR INPUTS

SI #	Sensor Inputs	Value	Manual Status	Offset	Sensor Type	Last On/Max Tdy	Last Off/Min Tdy	Run Tdy/Avg Tdy	Cycles Tdy	Run Ydy/Max Ydy	Cycles Ydy/Min Ydy	Ttl Run HRS/Avg Ydy	Total Cycles
M - 1	ChwIn Temp	-99.9F	AUTO	0.0F	MCST100	55.0F	-99.9F	45.0F		0.0F	0.0F	0.0F	
M - 2	ChwOutTemp	-99.9F	AUTO	0.0F	MCST100	65.0F	-99.9F	46.8F		0.0F	0.0F	0.0F	
M - 3	SUCT 1 PSI	-99.9P	AUTO	0.0P	MCS-500	128.0P	-99.9P	126.9P		0.0P	0.0P	0.0P	
M - 4	DISC 1 PSI	-99.9P	AUTO	0.0P	MCS 667	350.0P	-99.9P	347.9P		0.0P	0.0P	0.0P	
M - 5	SUCT 1 TMP	-99.9F	AUTO	0.0F	MCST100	60.0F	-99.9F	59.3F		0.0F	0.0F	0.0F	
M - 6	DISC 1 TMP	-99.9F	AUTO	0.0F	MCST100	155.0F	-99.9F	153.9F		0.0F	0.0F	0.0F	
M - 7	DISC 2 TMP	-99.9F	AUTO	0.0F	MCST100	155.0F	-99.9F	153.9F		0.0F	0.0F	0.0F	
M - 8	PUMP DOWN1	NO	AUTO	0	DIGITAL	11:57:56	12:02:31	00:24:05	4	00:00:00	0	0.41	5
M - 10	CMP 1 AMPS	0.0A	AUTO	0.0A	CT300	0.0A	0.0A	0.0A		0.0A	0.0A	0.0A	
1 - 1	CMP 2 AMPS	0.0A	AUTO	0.0A	CT300	0.0A	0.0A	0.0A		0.0A	0.0A	0.0A	
1 - 2	SUCT 2 PSI	-99.9P	AUTO	0.0P	MCS-500	0.0P	-99.9P	-0.3P		0.0P	0.0P	0.0P	
1 - 3	DISC 2 PSI	-99.9P	AUTO	0.0P	MCS 667	0.0P	-99.9P	-0.3P		0.0P	0.0P	0.0P	
1 - 4	SUCT 3 TMP	-99.9F	AUTO	0.0F	MCST100	0.0F	-99.9F	-0.3F		0.0F	0.0F	0.0F	
1 - 5	DISC 3 TMP	-99.9F	AUTO	0.0F	MCST100	0.0F	-99.9F	-0.3F		0.0F	0.0F	0.0F	
1 - 6	DISC 4 TMP	-99.9F	AUTO	0.0F	MCST100	0.0F	-99.9F	-0.2F		0.0F	0.0F	0.0F	
1 - 7	PUMP DOWN2	NO	AUTO	0	DIGITAL	11:44:41	12:02:45	00:18:27	2	00:00:00	0	0.31	2
2 - 1	CMP 3 AMPS	0.0A	AUTO	0.0A	CT300	0.0A	0.0A	0.0A		0.0A	0.0A	0.0A	
2 - 2	CMP 4 AMPS	0.0A	AUTO	0.0A	CT300	0.0A	0.0A	0.0A		0.0A	0.0A	0.0A	
2 - 3	CHW FLOW	NO	AUTO	0	DIGITAL	11:29:15	11:29:15	00:00:00	0	00:00:00	0	0.00	0
2 - 4	PHASE LOSS	TRIP	AUTO	0	DIGITAL	13:50:31	11:29:15	00:00:19	0	00:00:00	0	0.01	0
2 - 5	RUNSTOP SW	STOP	AUTO	0	DIGITAL	11:53:12	13:50:32	01:57:22	1	00:00:00	0	1.96	1
2 - 6	EMERG STOP	TRIP	AUTO	0	DIGITAL	13:50:33	11:53:16	00:00:28	1	00:00:00	0	0.01	1

The screen shot above shows the following features:

- SI Number – M-1 is on MicroMag relay 1, 1-1 is on RO board 1 relay 1.
- SI Names – A 10 character selected by the OEM for each input.
- SI Value – Actual analog value or for digital On or Off.
- SI Status – Auto or Manual
- SI Offset – Value to calibrate sensor..
- SI Type – Pressure, Temperature, Amps, etc.
- Last On/Last Off or Max Tdy/Min Tdy
- Run Tdy or Avg Tdy – Depending on analog or digital sensor.
- Cycles Today/Yesterday & Total.

7.5. MicroMag CONTROL STATES

The status of the control states of the unit can be viewed from MCS-Connect by clicking the “Status” screen in the Unit Status quadrant. The following screen will be displayed:

System (unit) information is shown in this section:

- **Unit State - State of unit - (CHILLER STATE, COMPRESSOR STATE, CONDENSER STATE)**
 - Time - Time spent in current state. If the state is UNIT IN POWER UP time will count down to zero.

System Status								
Unit State	Time							
PUMP ONLY	00:20:26							
Pump State	Pump Time							
PUMP ON	00:00:00							
Capacity State	Capacity Time	Stages Wanted/Active	Target	Control On	Wanted %	ADJ Delay	Rate of Change	
NO FLOW	00:20:48	0/0	45.0F	ChwOutTemp= 45.0F	----	----	0.0F	
Compressor State	Compressor Time	FLA %	Saturated Suction	Suction Superheat	Saturated Condenser	Disc Superheat	Oil Differential	Lead?
DISABLED	00:20:26	0	44.1	15.9	107.0	48.0	222.0P	Yes
DISABLED	00:20:26	0	44.1	15.9	107.0	48.0	222.0P	
DISABLED	00:20:26	0	-40.0	40.0	-40.0	40.0	0.0P	
DISABLED	00:20:26	0	-40.0	40.0	-40.0	40.0	0.0P	
EXV State	Time	Valve %	Control On Suct. Supht	SuperHeat ROC	ADJ Delay			
EXV CLOSED	00:47:25	0	15.9F	0.0F	60			
EXV CLOSED	00:47:25	0	40.0F	0.0F	60			
Condenser State	Condenser Time	Stages Wanted/Active	Target	Control On	Wanted %	ADJ Delay	Rate of Change	
COND OFF	00:47:23	0/0	300.0P	DISC 1 PSI= 350.0P	----	0	0.0P	

- **Target** – The setpoint value that wehn the controlling sensor is above or below will add/decrease capacity

- **Pump State** – Pump status is either on or off
 - **Time** - Time spent in current state.
 - **Target** – The current value of the controlling Setpoint.
- **Cooling State** – Can be loading AZ (above Zone, unloading BZ (below zone) or Holding IZ (in zone).
 - **Time** - Time spent in current state.
 - **Stages (Wanted/Active)** – Stages wanted on and stages currently on.
 - **Target** – The current target in the Setpoint.
 - **Control On** – The controlling sensor and it’s current value.
 - **Wanted %** - For a digital scroll this is the % capacity wanted.
 - **ADJ Delay** – This is the accumulator for the integration controlling the next capacity change.
 - **Rate of Change** - The current slope of the controlling sensor over the time specified in the Setpoint.
- **Compressor State** – Can be Off or Running.
 - **Time** - Time spent in current state
 - **FLA %** - Percent of full load amps as specified in Setpoint.
 - **Saturated Suction** – Calculated Suction Saturated Temperature.
 - **Suction Superheat** – Calculated Suction Superheat, only available if both the Suction Temperature and the Suction Pressure are used. Suction Superheat = Suction Temperature - Suction Saturated Temperature.
 - **Saturated Condenser** - Calculated Suction Saturated Temperature.
 - **Discharge Superheat** – Discharge Superheat is available only if both the Discharge Temperature and the Discharge Pressure are used. Discharge Superheat = Discharge Temperature - Discharge

Saturated Temperature.

- Oil Differential – Differential oil pressure is calculated if both suction pressure and discharge pressure are available.
- Lead - YES will be displayed for the lead compressor in this column.

7.6. MicroMag RESET/CLEAR

The screen shot above shows the Reset and Clear features:

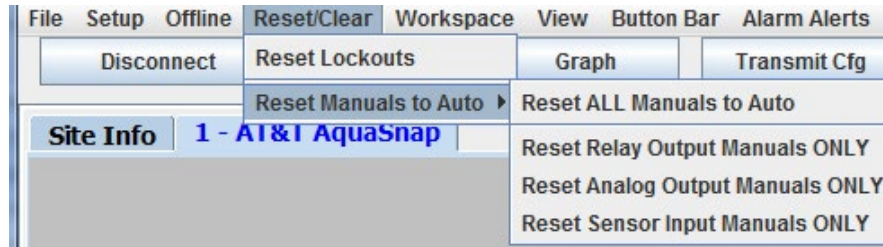

- Reset Lockouts – This does not require being authorized. However only a limited number of lockouts can be reset in one day without a higher authorization level.
- Clear Alarms - This function is limited to MCS or OEM.
- Clear Points - This function is limited to MCS or OEM.

7.7. MicroMag ALARMS

The screenshot shows the 'Alarms' window with a list of 20 alarms. The 'Info' button for the 13th alarm is highlighted. An inset window titled 'Lockout Alarm Information' is open, showing a detailed table of lockout data with columns for Time, ROs, SIs, AOs, Unit, Evap, Cool & Comp., Cond, Reheat, and Heat & ModGas. A 'Print' button is visible in the dialog box.

Click on 'INFO' to see additional information on the lockup. You can print out the information for viewing in a excel file.

The screen shot above shows the 1st 20 Alarms. There are a maximum of 100 of the most current.

- The alarms are numbered and the most current presented first.
- The alarms are named, this could be the name of a Setpoint or a specific alarm name.
- The alarms are date stamped.
- The alarms are time stamped.
- The alarms record a value where it's informative.

7.8. List of Alarms Generated by MicroMag

1. ALARMS CLEARED
2. AO CHANGED
3. AUTH CODES
4. CLOGGED FILTER
5. COMM TYPE BACNET
6. COMM TYPE BASE
7. COMM TYPE MCSIO
8. COMM TYPE MODBUS
9. COMPRESSOR SPEED
10. CONDENSER ALARM
11. CONFIG INVALID
12. CONFIG TRANSMITTED
13. DRAIN ALARM
14. EMERGENCY STOP
15. FAILED RO
16. FAILED SI
17. FIRE ALARM
18. FREEZE TEMP
19. HI AMPS ALARM
20. HI DISCHARGE PSI
21. HI MOTOR TEMP
22. HI OIL TEMP
23. HI SUPPLY TEMP
24. HIGH BUILDING PRESSURE
25. HIGH DISCH TEMP
26. HIGH DUCT PRESSURE
27. HIGH PSI SWITCH
28. HIGH PSI SWITCH
29. HIGH SUCT SUPERHEAT
30. IGNITION FAULT
31. KEYPAD ALARM BREAKPOINT
32. LO DISC SUPERHEAT
33. LO SUCT SUPERHEAT
34. LOAD ALARM
35. LOCKOUT RESET
36. LOST IO RESTART
37. LOW AMPS ALARM
38. LOW DISC PSI
39. LOW OIL DIFF PSI
40. LOW PSI SWITCH
41. LOW PSI SWITCH
42. LOW SUCTION PSI
43. MODBUS ANALOG CHANGED
44. MODBUS CONFIGURATION CHANGED
45. MODBUS CONSTANT CHANGED
46. MODBUS RELAY CHANGED
47. MODBUS SI CHANGED
48. NETWORK OCCUPIED
49. NETWORK RUN STOP
50. NO COMP PROOF
51. NO FLOW
52. OIL LEVEL
53. PHASE LOSS
54. POINT INFO CLEARED
55. POWER ON
56. PRECOOL FREEZE TEMP
57. PUMP DOWN
58. REMOTE STOP
59. RO CHANGED
60. RTC INVALID
61. SENSOR FAULT
62. SETPOINT CHANGED
63. SI CHANGED
64. SMOKE ALARM
65. THERMOSTAT COMM FAILED
66. UNSAFE OIL DIFF PSI
67. UNSAFE SUCTION
68. USER CYCLE COUNT RESET
69. VFD FAULT

7.9. MicroMag SCHEDULES

Day	#1 Time On	#1 Time Off	#2 Time On	#2 Time Off
Sunday	8:00	8:00	8:00	8:00
Monday	8:00	18:30	8:00	18:00
Tuesday	8:00	18:30	8:00	18:00
Wednesday	8:00	18:30	8:00	18:00
Thursday	8:00	18:30	8:00	18:00
Friday	8:00	18:30	8:00	18:00
Saturday	8:00	8:00	8:00	8:00
Holiday	8:00	17:00	8:00	17:00

Holiday #	Start Month	Start Day	End Month	End Day
1	December	15	December	21
2	December	15	December	21
3	December	15	December	21
4	December	15	December	21
5	December	15	December	21
6	December	15	December	21
7	December	15	December	21
8	December	15	December	21

Status	Alarms	SetPoints	Reset/Clear	Schedule
--------	--------	-----------	-------------	-----------------

The screen shot above shows the schedules.

- There are 2 on/off schedules per day.
- There are 7 days and 1 holiday schedule.
- There are 8 holiday dates.

7.10. MicroMag INFORMATION SCREEN

<ol style="list-style-type: none"> 1. The Sensor Input Value, Manual Status, Type and Offset Value can be changed by clicking on the cell. 2. Information on Control States and the status of the system. 3. The Sensor Input Value, Manual Status, Type and Offset Value can be changed by clicking on the cell. 4. Information on the Schedule for this Magnum 5. The Sensor Input Value, Manual Status, Type and Offset Value can be changed by clicking on the cell.

The screen shot above shows the information screen acknowledging action taken.

- Information is provided.
- Confirmation is given that a function has been done.

Chapter - 9. MCS-CONNECT - GRAPHICS

9.1. Graphics Screen

MCS-Graphics is a feature available in MCS-CONNECT. The Graphics feature allows the user to view a graphical interface for your controller using the touch screen or your PC.

To get to the 'GRAPHICAL' interface follow the instructions below.

1. At MCS-CONNECT main screen click on the 'SERIAL' button to scan for your controller. On a PC you must have a MCS-USB-RS485 cable from your PC to the MicroMag RS485 port.

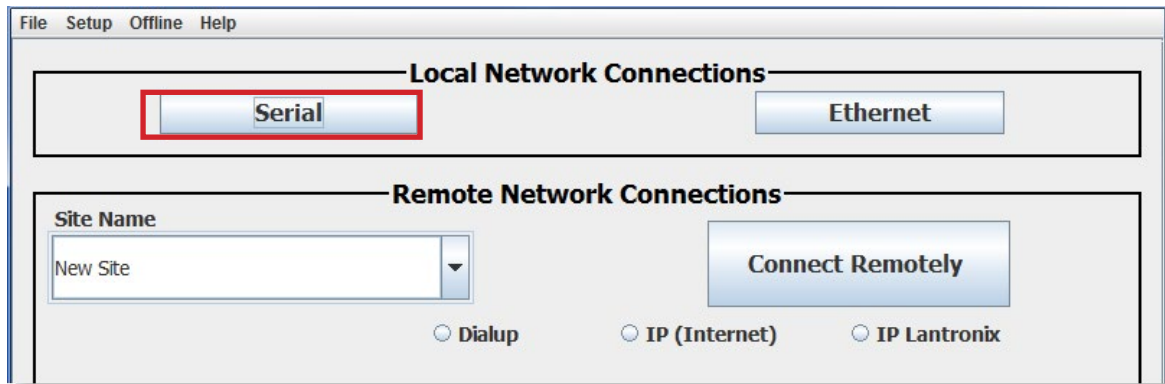

2. Scan shows 1 controller for the MicroMag controller.
3. Click on the controller to open.

The screenshot shows the MCS-CONNECT status screen. At the top, there are menu options: File, Setup, Offline, Reset/Clear, Workspace, View, Button Bar, Time, Help, Live Graph, Extended History - Inactive, ALARM ALERTS-INACTIVE. Below this, there are several buttons: Disconnect, Scan, Graph, Transmit Cfg, Receive Cfg, View Only, Load Firmware, Diagnostic Save, Print, Graphics, Alarms. The main content area shows 'Site Info 1 - uMag AAON' and a table with the following data:

Address	HW Serial #	Cfg Name	Company Name	Unit Model #	Unit Serial #	Installed Date	Cfg Vers.	Firmware Vers.	Cfg Date
(1)	065535	uMag AAON	MCS	WJR	uMag_V18C	09/12/2016	18	AAON 18.00C	02/15/2017

4. Next screen shows status screen in MCS-CONNECT for your controller.

The screenshot shows the MCS-CONNECT status screen for '1 - uMag AAON'. The top menu bar includes: File, Setup, Offline, Reset/Clear, Workspace, View, Button Bar, Time, Help, Live Graph, Extended History - Inactive, ALARM ALERTS-ACTIVE. Below the menu bar are buttons: Disconnect, Scan, Graph, Transmit Cfg, Receive Cfg, View Only, Load Firmware, Diagnostic Save, Print, Graphics, Alarms. The main content area is divided into several panels:

- Cooling Status:** A table showing cooling state (DISABLED), cooling time (00:00:00), stages wanted/active (0/0), target (74.0F), control on (N/A= 0.0F), wanted % (30), ADJ Delay (----), and rate of change (0.0F). It also includes compressor state (OFF&READY) and condenser state (COND OFF).
- Analog Outputs:** A table showing analog outputs (AO #, Analog Outputs, Value, Manual Status, Type, Max TDY, Min TDY, Avg TDY, Max YDY, Min YDY, Avg YDY) for AO #1 (Comp Spd 1), AO #2 (Comp Spd 2), and AO #3 (Heat Dmnd 1).
- Relay Outputs:** A table showing relay outputs (RO #, Relay Outputs, Value, Manual Status, Last On, Last Off, Run Today, Cycles Today, Run Ydy, Cycles Ydy, Total Run Hrs, Total Cycles) for RO #1 (Cool 1), RO #2 (Cool 2), and RO #3 (Alarm).
- Sensor Inputs:** A table showing sensor inputs (SI #, Sensor Inputs, Value, Manual Status, Offset, Sensor Type, Last On/ MAX TDY, Last Off/ MIN TDY, Run TDY/ Avg TDY, Cycles TDY, Run YDY/ Max YDY, Cycles YDY/ Min YDY, Total Run HRS/ Avg YDY, Total Cycles) for sensors M-1 through M-10.

At the bottom of the screen, there are buttons for: Schedule, Service, Unit Status, Heat Status, Alarms, Setpoints, Information F...

5. When you received your new controller, the MCS-CONFIG program has been setup to locate your graphic file.

1. If you need to change the graphics for your controller, follow the steps on the next page.

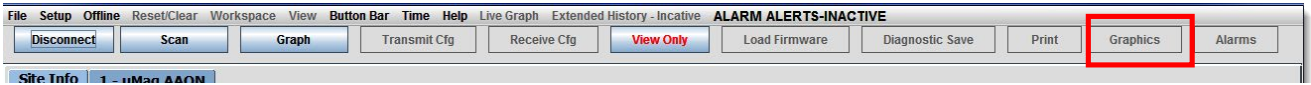

2. Click the button for 'GRAPHICS' to open the graphical interface as shown below.

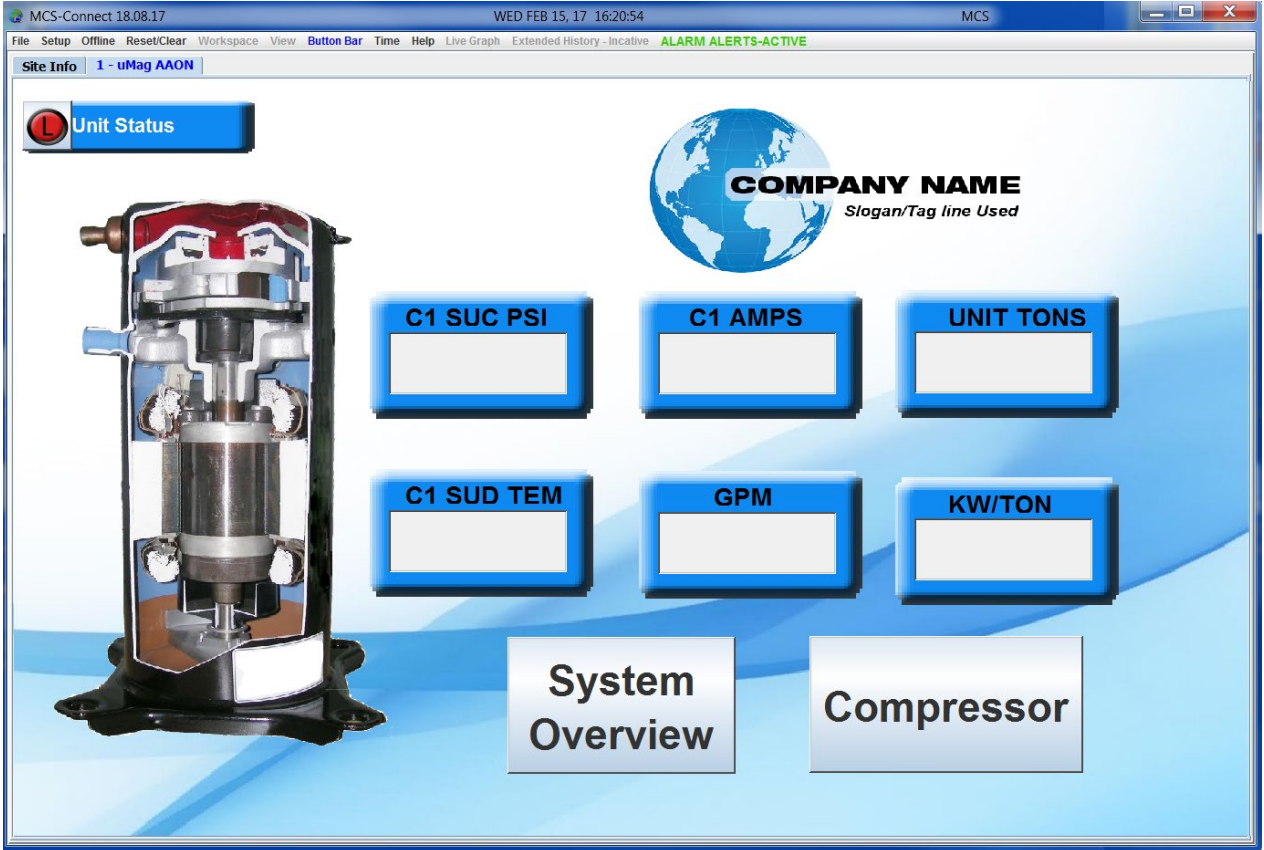

9.2. Changing the Graphics

If you need to change the 'GRAPHICS PACKAGE' for your controller, consult with MCS SUPPORT for upgrading.

Follow the steps below for changing the your graphics.

For changing the graphic package on a touchscreen, download the 'TOUCHSCREEN AND GRAPHICS MANUAL' located on our web site at:

<http://www.mcscontrols.com/manuals.html>

When you receive your new 'GRAPHIC.ZIP' file, double click to open the file and place the new file in the MCS/GRAPHICS location on your 'C' drive on your computer.

If the graphics file is the same name as the old file, click okay to overwrite the old file.



NOTE: YOU SHOULD ALWAYS BACKUP YOUR FILES PRIOR TO LOADING NEW GRAPHIC FILES.

If the file name was the same you can skip the next steps and proceed to open your graphics as was explained above.

IF NOT PROCEED TO THE NEXT STEPS ON THE FOLLOWING PAGE

9.2.1 Graphics File Update

Follow the steps below to register a new graphic file for your controller.

1. At the status screen of MCS-CONNECT, click on the 'SERVICE' button at the bottom of the screen.

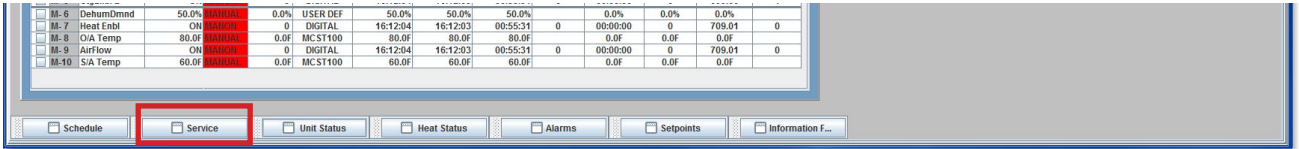

2. The service window will open, click on the Graphics tab to open.

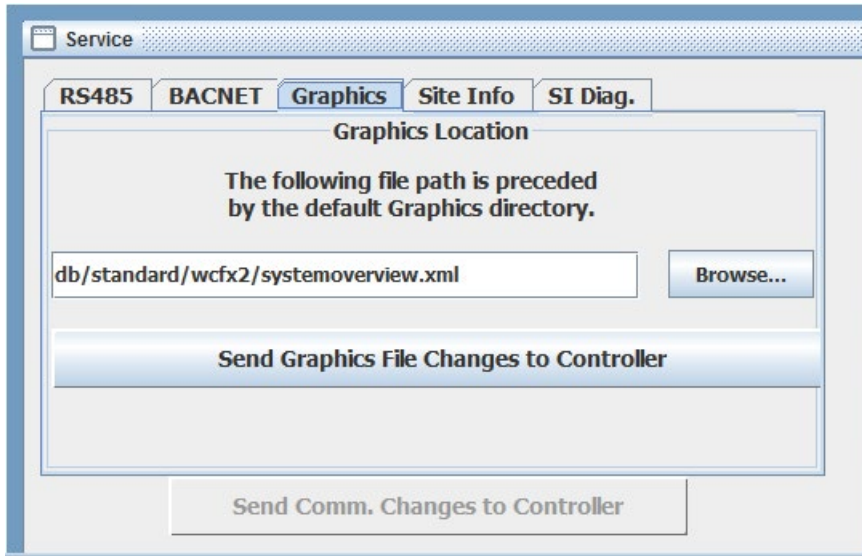

3. Click on the 'BROWSE' button to search for your graphics package. If you placed the file in the MCS/GRAPHICS sub folder, you can click on the file. The location of the file should show in the box next to browse.
4. Click '**SEND GRAPHICS FILE CHANGES TO CONTROLLER**'
5. Your controller should reboot in MCS-CONNECT, click on the '**GRAPHICS**' tab at the top to view your new graphics.

Chapter - 10. Displaying Setpoints

10.1. Keypad/Display

1. Press 'MENU' button
2. Press 'DOWN' button until the Setpoints screen appears
3. Press 'ENTER' button

10.2. MCS-Connect

1. Using MCS-Connect, connect to the MicroMag using the RS 485 port
2. If multiple units select tab for this MicroMag and you will get a status display
3. In the bottom of the control section, of the status display, select Setpoints

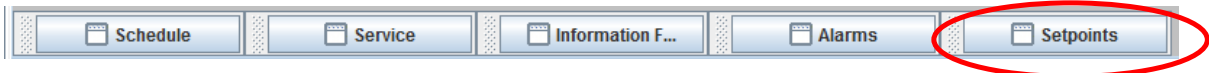

10.2.1 MCS Chiller setpoints for HVAC unit being monitored

#	SetPoints	Value	Time	Zone	Max ROC	ROC Interval	Adj Mult.	Adj Div.	Min Adj	Max Adj	Min Capac.	Max Capac.	Delay Mult.	Delay Div.	SEC Ignore	Window EXT	Safety EXT	Time B	Time C	Type
8	ChwOut TRGT	45.0F	-----	1.0F	0.8F	60 S	1	5	-----	-----	-----	-----	-----	-----	-----	-----	-----	-----	-----	TARGET
9	ChwStepDelay	300s	-----	-----	-----	-----	-----	-----	2.0 %	25.0 %	0 %	100 %	1	1	-----	-----	-----	-----	-----	ADJUST
17	CND TRGT PSI	300.0P	-----	7.0P	0.5P	10 S	1	1	-----	-----	-----	-----	-----	-----	-----	-----	-----	-----	-----	TARGET
18	CND STEP DLY	60s	-----	-----	-----	-----	-----	-----	2.0 %	20.0 %	20 %	100 %	1	5	-----	-----	-----	-----	-----	ADJUST
37	LEAD COMP	0	-----	-----	-----	-----	-----	-----	-----	-----	-----	-----	-----	-----	-----	-----	-----	-----	-----	SETPOINT
38	CompRotation	0D	-----	-----	-----	-----	-----	-----	-----	-----	-----	-----	-----	-----	-----	-----	-----	-----	-----	SETPOINT
39	COMP MIN RUN	2m	-----	-----	-----	-----	-----	-----	-----	-----	-----	-----	-----	-----	-----	-----	-----	-----	-----	SETPOINT
40	ACYC ON-ON	10s	-----	-----	-----	-----	-----	-----	-----	-----	-----	-----	-----	-----	-----	-----	-----	-----	-----	SETPOINT
41	ACYC OFF-ON	10s	-----	-----	-----	-----	-----	-----	-----	-----	-----	-----	-----	-----	-----	-----	-----	-----	-----	SETPOINT
42	PMP DOWN PSI	85.0P	-----	-----	-----	-----	-----	-----	-----	-----	-----	-----	-----	-----	-----	-----	-----	-----	-----	SETPOINT
43	PmpDownDelay	60s	-----	-----	-----	-----	-----	-----	-----	-----	-----	-----	-----	-----	-----	-----	-----	-----	-----	SETPOINT
46	SftyHoldDelay	60s	-----	-----	-----	-----	-----	-----	-----	-----	-----	-----	-----	-----	-----	-----	-----	-----	-----	SETPOINT
51	COMPR 1 FLA	21.0A	-----	-----	-----	-----	-----	-----	-----	-----	-----	-----	-----	-----	-----	-----	-----	-----	-----	SETPOINT
52	COMPR 2 FLA	21.0A	-----	-----	-----	-----	-----	-----	-----	-----	-----	-----	-----	-----	-----	-----	-----	-----	-----	SETPOINT
53	COMPR 3 FLA	21.0A	-----	-----	-----	-----	-----	-----	-----	-----	-----	-----	-----	-----	-----	-----	-----	-----	-----	SETPOINT
54	COMPR 4 FLA	21.0A	-----	-----	-----	-----	-----	-----	-----	-----	-----	-----	-----	-----	-----	-----	-----	-----	-----	SETPOINT
55	LOW AMP %	20.0%	10 S	-----	-----	-----	-----	-----	-----	-----	-----	-----	-----	-----	10 S	60 S	10 S	-----	-----	LOCKOUT
56	HIGH AMP %	120.0%	2 S	-----	-----	-----	-----	-----	-----	-----	-----	-----	-----	-----	5 S	60 S	2 S	-----	-----	LOCKOUT
62	LOW SUCT PSI	90.0P	10 S	-----	-----	-----	-----	-----	-----	-----	-----	-----	-----	-----	0 S	0 S	0 S	-----	-----	LOCKOUT
64	UNSAFE SUCT	5.0P	5 S	-----	-----	-----	-----	-----	-----	-----	-----	-----	-----	-----	0 S	120 S	6 S	-----	-----	LOCKOUT
67	LO SUCT SPHT	3.0F	300 S	-----	-----	-----	-----	-----	-----	-----	-----	-----	-----	-----	0 S	10 S	120 S	-----	-----	ALM ONLY
69	LOW DISC PSI	200.0P	90 S	-----	-----	-----	-----	-----	-----	-----	-----	-----	-----	-----	0 S	0 S	0 S	-----	-----	LOCKOUT
70	HI DISC PSI	550.0P	2 S	-----	-----	-----	-----	-----	-----	-----	-----	-----	-----	-----	0 S	0 S	0 S	-----	-----	LOCKOUT
73	HI DISC TEMP	215.0F	2 S	-----	-----	-----	-----	-----	-----	-----	-----	-----	-----	-----	0 S	0 S	0 S	-----	-----	LOCKOUT
86	FREEZE TEMP	38.0F	5 S	-----	-----	-----	-----	-----	-----	-----	-----	-----	-----	-----	0 S	0 S	0 S	-----	-----	LOCKOUT
89	CFG TEST = 0	0	-----	-----	-----	-----	-----	-----	-----	-----	-----	-----	-----	-----	-----	-----	-----	-----	-----	SETPOINT
132	EXV TARGET	12.0F	-----	1.0F	0.2F	4 S	2	1	-----	-----	-----	-----	-----	-----	-----	-----	-----	-----	-----	TARGET
133	EXV ADJUST	60s	-----	-----	-----	-----	-----	-----	0.1 %	0.5 %	10 %	100 %	1	1	-----	-----	-----	-----	-----	ADJUST
134	EXV LO SPRHT	2.0F	300 S	-----	-----	-----	-----	-----	-----	-----	-----	-----	-----	-----	-----	-----	-----	0 S	0 S	TIME
135	EXV MOP TARG	175.0P	-----	5.0P	0.0P	10 S	1	1	-----	-----	-----	-----	-----	-----	-----	-----	-----	-----	-----	TARGET

Chapter - 11. MICROMAG ALARMS - MCS-CONNECT

- Last 100 Alarms are saved
- In print out below a LOCKOUT was created. (#21)
- The System responded with “SPLY FREEZE” Alarm & Info (#13)
- The Freeze was reset (#11)

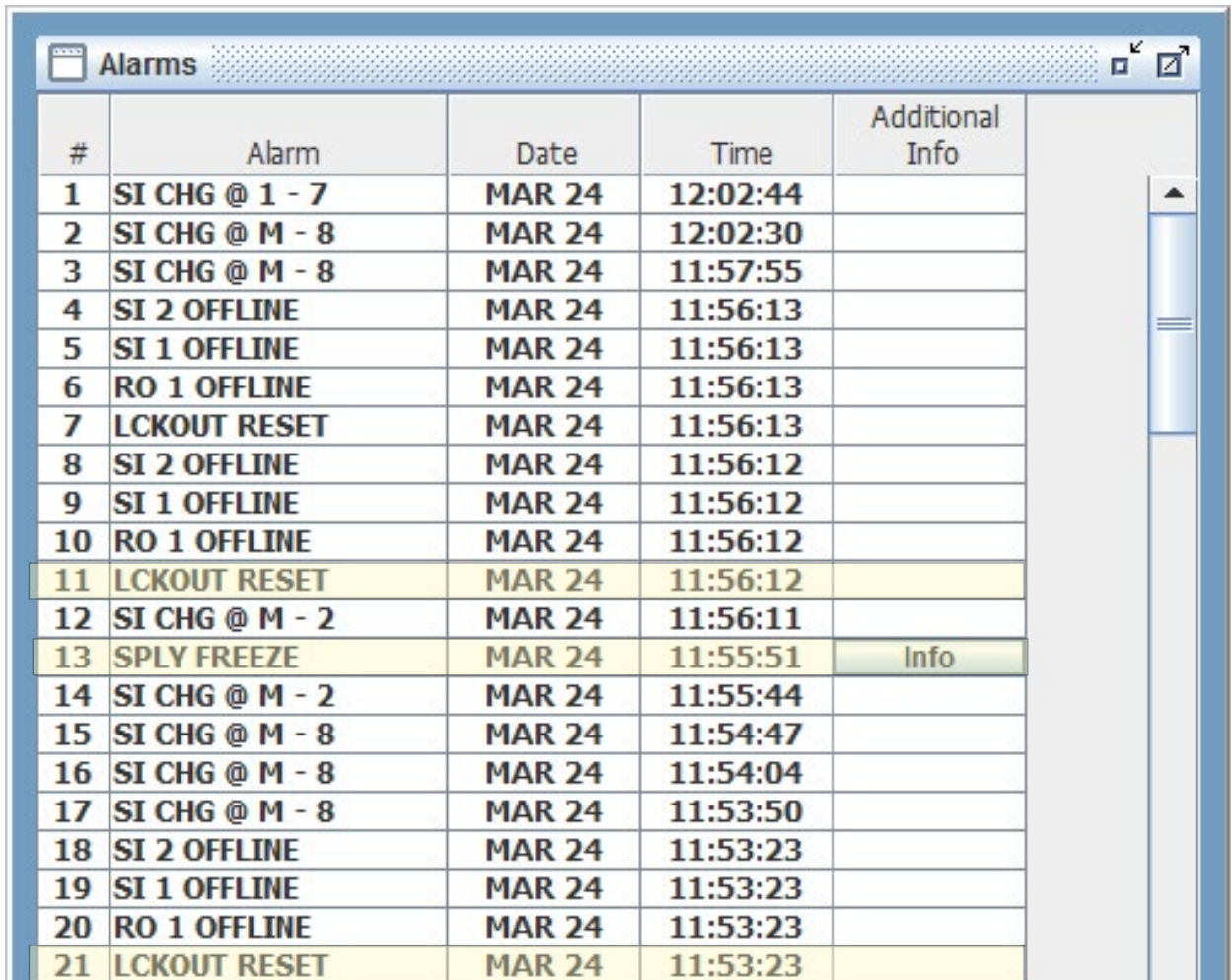

The screenshot shows a window titled "Alarms" with a table of alarm events. The table has five columns: "#", "Alarm", "Date", "Time", and "Additional Info". The events are listed in chronological order from top to bottom. Row 13, "SPLY FREEZE", is highlighted in yellow and has "Info" in the "Additional Info" column. Row 11, "LCKOUT RESET", is also highlighted in yellow. Row 21, "LCKOUT RESET", is highlighted in yellow. The other rows are not highlighted.

#	Alarm	Date	Time	Additional Info
1	SI CHG @ 1 - 7	MAR 24	12:02:44	
2	SI CHG @ M - 8	MAR 24	12:02:30	
3	SI CHG @ M - 8	MAR 24	11:57:55	
4	SI 2 OFFLINE	MAR 24	11:56:13	
5	SI 1 OFFLINE	MAR 24	11:56:13	
6	RO 1 OFFLINE	MAR 24	11:56:13	
7	LCKOUT RESET	MAR 24	11:56:13	
8	SI 2 OFFLINE	MAR 24	11:56:12	
9	SI 1 OFFLINE	MAR 24	11:56:12	
10	RO 1 OFFLINE	MAR 24	11:56:12	
11	LCKOUT RESET	MAR 24	11:56:12	
12	SI CHG @ M - 2	MAR 24	11:56:11	
13	SPLY FREEZE	MAR 24	11:55:51	Info
14	SI CHG @ M - 2	MAR 24	11:55:44	
15	SI CHG @ M - 8	MAR 24	11:54:47	
16	SI CHG @ M - 8	MAR 24	11:54:04	
17	SI CHG @ M - 8	MAR 24	11:53:50	
18	SI 2 OFFLINE	MAR 24	11:53:23	
19	SI 1 OFFLINE	MAR 24	11:53:23	
20	RO 1 OFFLINE	MAR 24	11:53:23	
21	LCKOUT RESET	MAR 24	11:53:23	

- Click on 'Info'.
- Click on the tab selecting the items you want to see.
- By selecting the "SI's" you can see the freeze temperature at @ 34°F.
- You can review all other info to see effect.

Lockout Alarm Information

RDs	SI's	ADs	Unit	Evap	Cool & Comp.	Cond	Reheat	Heat & ModGas
Time	SPLY TEMP □	OUTDR TEMP□	OUTDR HUM...	SPACE TEMP□	AIR FLOW □	RUNSTOP S...	CLOG FILTR□	BLD STATIC□
14:05:47	34.0F	88.0F	55.0%	75.0F	ON	ON	OFF	0.01"
14:05:46	34.0F	88.0F	55.0%	75.0F	ON	ON	OFF	0.01"
14:05:45	34.0F	88.0F	55.0%	75.0F	ON	ON	OFF	0.01"
14:05:44	34.0F	88.0F	55.0%	75.0F	ON	ON	OFF	0.01"
14:05:43	34.0F	88.0F	55.0%	75.0F	ON	ON	OFF	0.01"
14:05:42	34.0F	88.0F	55.0%	75.0F	ON	ON	OFF	0.01"
14:05:41	34.0F	88.0F	55.0%	75.0F	ON	ON	OFF	0.01"
14:05:40	34.0F	88.0F	55.0%	75.0F	ON	ON	OFF	0.01"
14:05:39	34.0F	88.0F	55.0%	75.0F	ON	ON	OFF	0.01"
14:05:38	34.0F	88.0F	55.0%	75.0F	ON	ON	OFF	0.01"
14:05:37	34.0F	88.0F	55.0%	75.0F	ON	ON	OFF	0.01"
14:05:36	34.0F	88.0F	55.0%	75.0F	ON	ON	OFF	0.01"
14:05:35	34.0F	88.0F	55.0%	75.0F	ON	ON	OFF	0.01"
14:05:34	34.0F	88.0F	55.0%	75.0F	ON	ON	OFF	0.01"
14:05:33	34.0F	88.0F	55.0%	75.0F	ON	ON	OFF	0.01"

Chapter - 12. Graph Capabilities of MicroMag and MCS-CONNECT

MCS-CONNECT has the ability to pull back both 'STATIC' and 'LIVE GRAPH' trending history for the MicroMag controller it is monitoring.

The MicroMag controller captures history of the status for all RO, AO and SI points based on the setup of your configuration file. Through MCS-Config, the user is also able to setup additional "USER LOGIC" statements to capture additional internal information for plotting.

For example, you might want to capture and 'graph' information on the Unit States, Compressor States, EXV States, Number of compressors Wanted on and Actual on, Suction and Discharge Superheat, Saturated Suction and Discharge, etc. The insert on the right shows an example of setting up EXV State.

When the GRAPH button is selected, the screen below will appear. On the MCS-8 the # of samples is 144 and can be retrieved in about 1 minute. In the MAGNUM the number of samples is 1008 and will take about 3 + minutes to pull back.

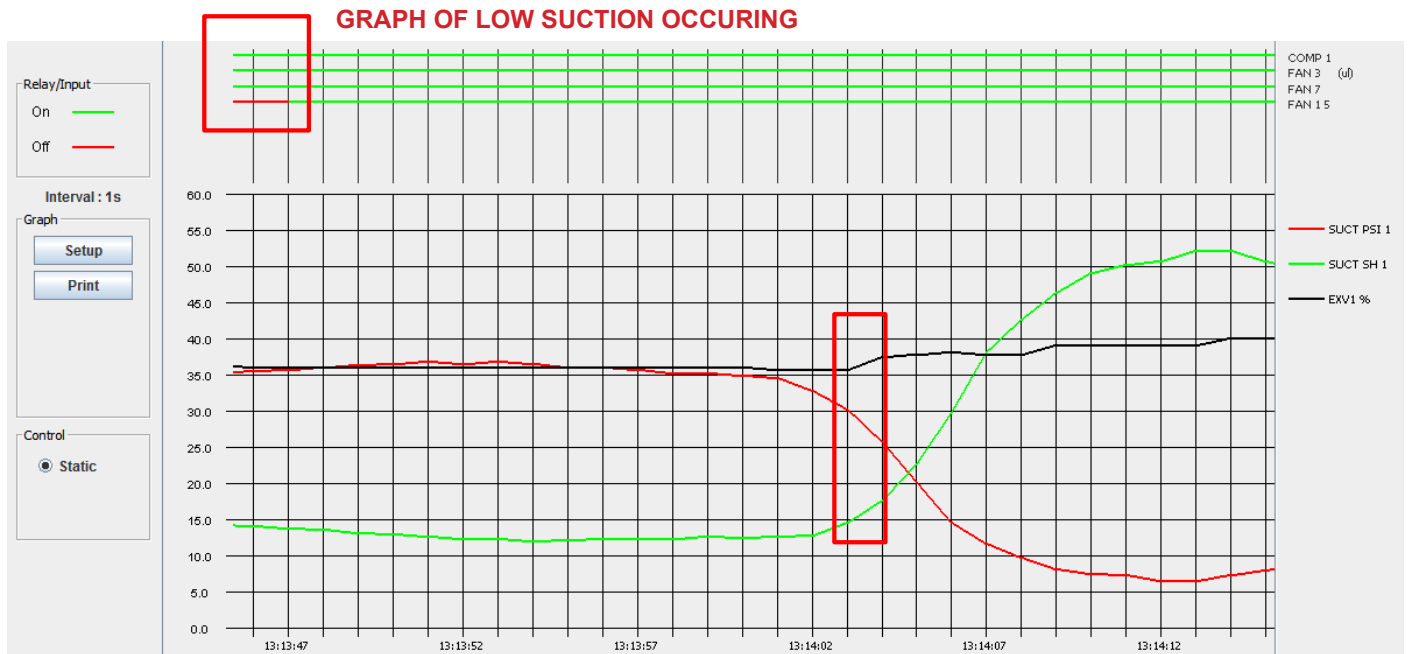
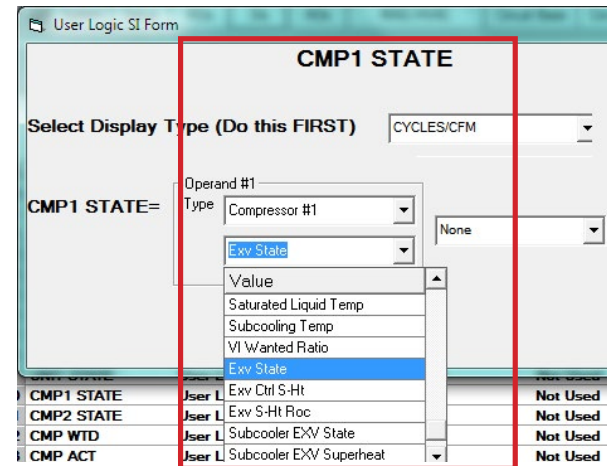

The above screen contains the following:

The Relay Outputs and the Digital Inputs are graphed across the top of the screen with line bars. The ON/OFF status coding is indicated to the left of the line bars and the name of the set points

being graphed is on the right. The items being graphed can be changed in the SETUP screen.

The Analog Inputs are charted on the graph grid. The name of the points being graphed is to the right of the grid, note the color-coding. The slide bar on the bottom of grid is used to move the portion of the graph being displayed. The X-axis contains the time intervals, and Y-axis, contains the value range. Items being graphed can be changed in the SETUP function.

The following pages will show you how to setup for seeing and saving the Graph History for your unit.

All inputs & outputs are saved on an ongoing basis. There are 300 of the most current samples available when requested. The time period covered is based on the sample time selected.

The chart below provides some indication of the time span covered based on the static time selected.

SAMPLE TIME	TIME COVERED
1 SEC	0 HR 5 MIN
6 SEC	0 HR 30 MIN
30 SEC	2 HR 30 MIN
1 MIN	5 HR 0 MIN
10 MIN	2 DAY 2 HRS
30 MIN	6 DAYS 6 HRS
60 MIN	12 DAYS 12 HRS



To pull back the current static data, from the status display in MCS-Connect, click the “Graph” tab.
To pull back a ‘LIVE GRAPH’, click on the ‘LIVE GRAPH’ tab.

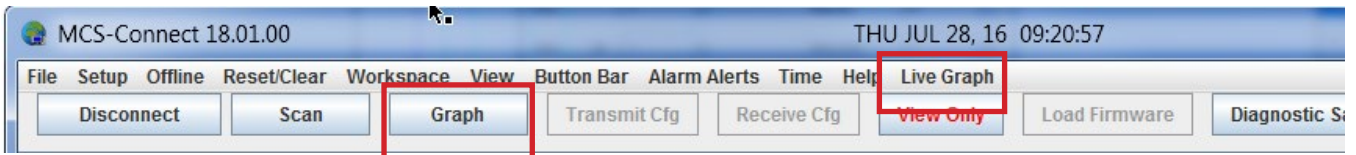

**FOR ADDITIONAL INFORMATION ON THE GRAPH CAPABILITIES OF YOUR
MICROMAG CONTROLLER**

PLEASE REFER TO THE MCS-CONNECT MANUAL AT:

www.mcscontrols.com

12.1. Graph Setup Tabs

When you click on the Graph button, the screen will display the following, plus if you have a saved 'GRAPH FILE', MCS-CONNECT will begin pulling back the history for the points you have saved for that graph file. Click on 'STOP HISTORY PULLBACK' to setup a new 'GRAPH'.

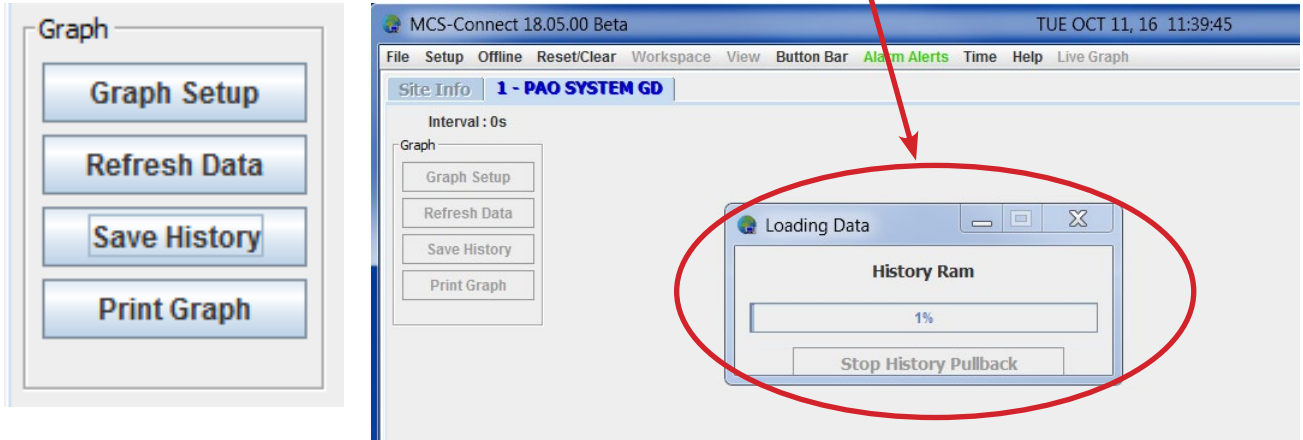

12.1.1 Graph Setup Button

This function allows changes to be made to the graph setup function.

When the SETUP button is clicked on, the following screen will appear. Here you will pick the points you want to graph, the 'INTERVAL(time)', and the 'Y-AXIS values'

12.1.1.1. Interval and Y AXIS SETUP

1. **Interval (s)** - Sets the given amount of seconds (time) you wish to graph
2. **Y-Axis Max** - Highest point of the graph
3. **Y-Axis Min** - Lowest point of the graph

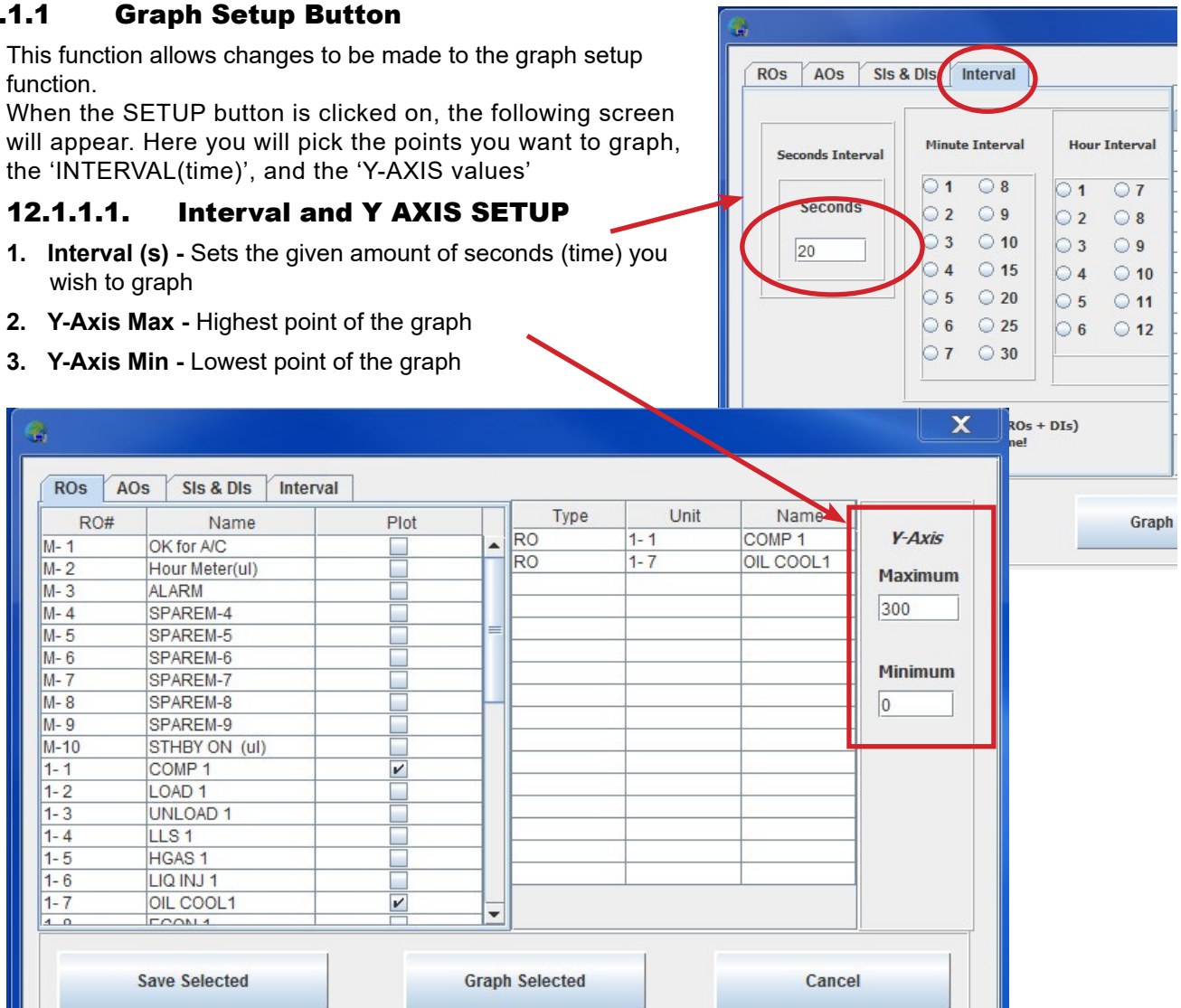

This Graph setup screen displays in tabbed pane at top of the screen: the RELAY OUTPUTS(RO), ANALOG OUTPUT(AO), SENSOR INPUT(SI's) or DIGITAL INPUT(DI's) of all the points in this configuration file.

To add a point to the list that will be graphed, move the cursor to the check box next to the point you wish to graph, and click. The name will be added to the Points to Graph list in the right screen of the popup and a check mark will appear in the box. To remove an item from the list, click on the box to remove the check mark. The item will be removed from the Points to Graph list.

When you are finished adding the points, you can click 'Save Selected', which will save all points for the controller you are viewing. If you view another MCS controller you can setup the graph points so each time you view the MCS controller your points for the graph will be loaded for that MCS controller.

Clicking 'Graph Selected' will plot the current selections in the graph.

The Y-Axis section contains the maximum and minimum setting for the Y-axis. The axis is divided proportionally between these two points divided by the # of lines specified.

YOU ARE LIMITED TO A MAXIMUM OF EIGHT(8) DIGITALS AND EIGHT (8) ANALOGS ON A GRAPH

Click on Interval to see the setup for the sampling times.

The Interval tab enables the interval to be changed. The time is recorded in seconds. Click on the appropriate radio buttons in minutes or hours. The Seconds History Interval Box automatically updates in seconds. (You may double click on the seconds box and put in a value as small as 2 seconds).

Save Selected- Clicking on this button will enable the current settings to be saved. If the settings are saved, they will be active when the system is again accessed.

Cancel - Clicking on this button will return control to the GRAPH screen. None of the changes that were made will be reflected on this screen. The original settings will be used.

12.1.2 Refresh Data Button

This function will reread the history data that is being accumulated, thus providing fresh data to be graphed.

12.1.3 Save History Button

This function will save the current history data with sensor names as a '.Txt' formatted file.

The standard Window SAVE AS screen will appear. Specify the name of the file and where it is to be saved. The file can be read into a spreadsheet program such as EXCEL and then graphs, charts etc can be produced using the graphing capabilities of the spreadsheet program.

The Magnum supports 1008 History Samples for all inputs & outputs.

By adding the MCS-COMPACT (which uses Flash 2G cards) to the Magnum this increases the storage history up to a year+ of run data.

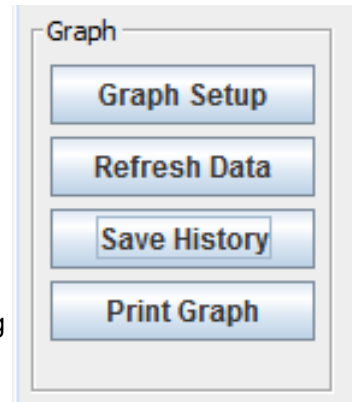

12.1.4 Print Graph

Prints the current Graph on the screen.

Chapter - 13. Diagnostic Save 'EASY BUTTON'

13.1. Diagnostic Save

Clicking on 'DIAGNOSTIC SAVE' allows the users to save files which can be viewed in a txt program such as Notepad or better yet in Excel.

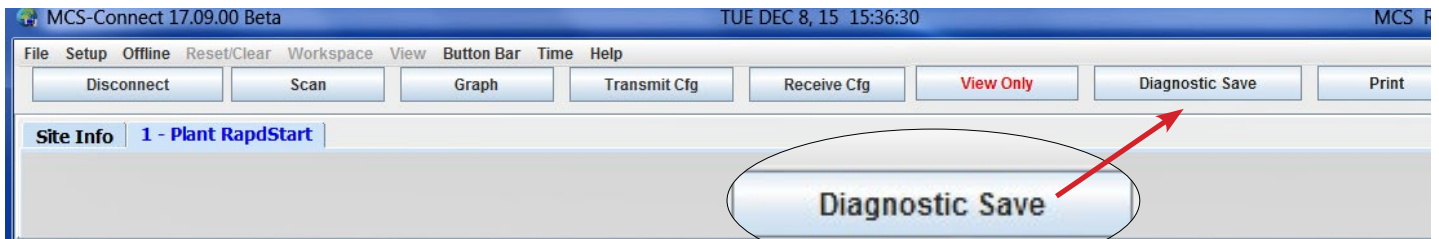

The screen on right appears alerting the user that MCS-CONNECT is ready to perform a diagnostic save of the unit that is being monitored.

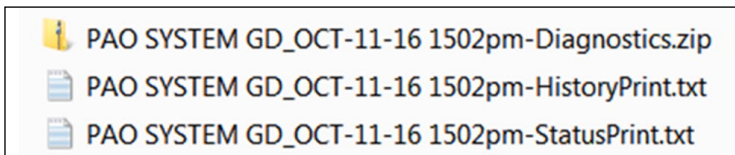
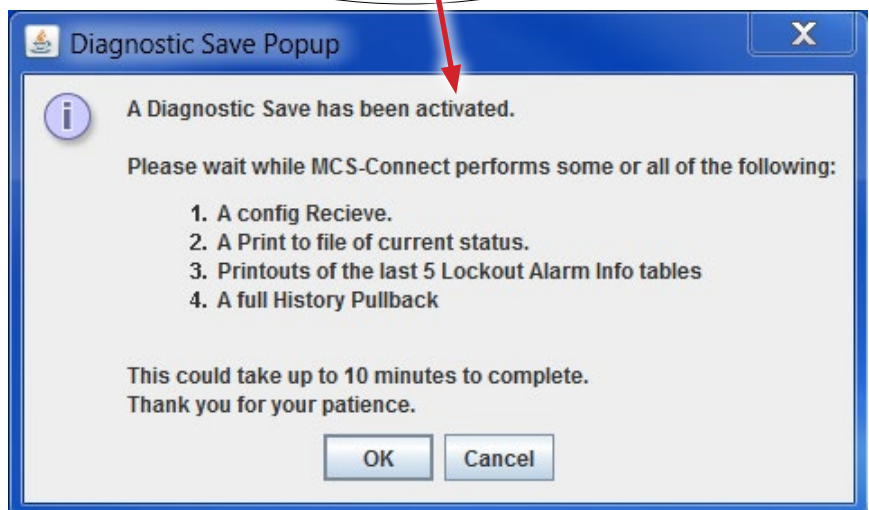

Saves a Zip file to your computer and can Auto Email zip file to: support@mcscontrols.com

'The Easy Button'
for MCS-CONNECT

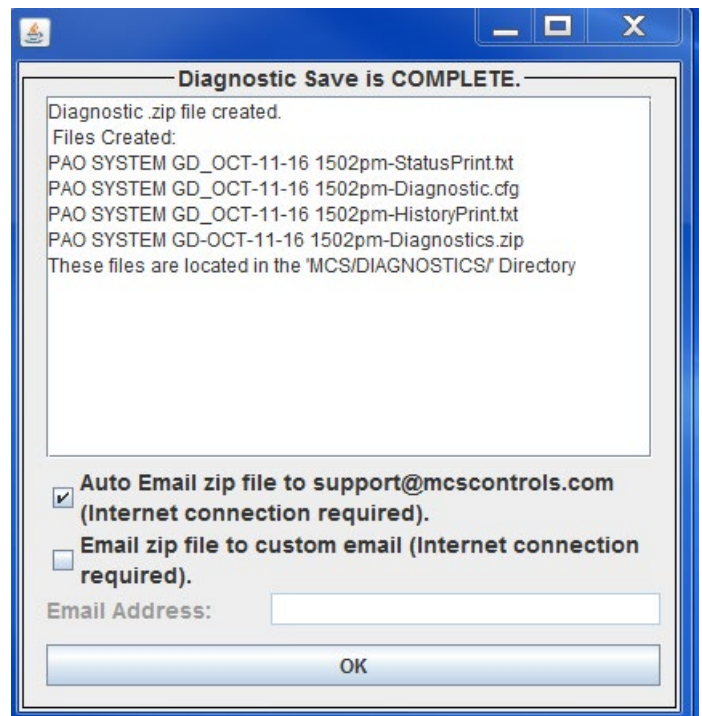

Chapter - 14. MCS-CHILLER MODES OF OPERATIONS

The MicroMag Chiller firmware allows support of the following HVAC modes of operations:

Mode	Description
Cooling	Stages capacity up/down to maintain target temperature.
Off	The unit will be off if run/stop sensor input is in stop.

14.1. MicroMag Scheduling

The MicroMag software consists of the following scheduling capabilities:

Schedule Type	Description
Weekly	Two (2) Start/Stop schedules per day
Holidays	Scheduling for 8 holidays with two (2) Start/Stops

14.2. MicroMag Proof of Flow

The MicroMag firmware support of the Proof of Flow:(Hardwired to sensor input)

Options	Description
Proof of Flow switch	Should use an isolation relay on the flow switch., optional part to order or provided by others, uses 5 vdc from MicroMag

14.3. MicroMag Warning Notification

The MicroMag firmware supports both Warnings and Alarms. There are adjustable set points for all functions. If the circuit trips it goes into a safety the first time. If it fails twice on the same circuit and the same failure within 2 hours the circuit locks out. A manual Lockout/Clear is required. Alarms are posted in the Alarm List.

- The last 100 Warnings/Alarms are available to view via the 2 x 16 MicroMag display.
- Alarms can be viewed via MCS-Connect on a Laptop or Touchscreen.
- An Alarm relay out is a hardwired option.

Options	Description
Warnings	<p>Warnings are potential failures in which the MicroMag is taking corrective action</p> <ul style="list-style-type: none"> • Low Suction PSI (Requires Suction Pressure Transducer) • Hi Discharge PSI (Requires Suction Pressure Transducer) • Low suction Temp (Requires Suction Temp Sensor per circuit) • Hi Discharge Temp (Requires Discharge Temp sensor per circuit) • Low Amp/No Start (Requires amp sensor per circuit) • Information Sensor failures

14.4. MicroMag Alarm Notification

Options	Description
Alarms	<ul style="list-style-type: none"> • Unsafe suction (Requires Suction Pressure Transducer) • All critical Sensor failures required for control. • Information Sensor failures • The 2nd time the following failures occur within 2 hours (User settable): <ul style="list-style-type: none"> ○ Low Suction PSI (Requires Suction Pressure Transducer) ○ Hi Discharge PSI (Requires Suction Pressure Transducer) ○ Low suction Temp (Requires Suction Temp Sensor per circuit) ○ Hi Discharge Temp (Requires Discharge Temp sensor per circuit) ○ Low Amp/No Start (Requires amp sensor per circuit)

14.5. MicroMag Lockout Alarm Information

The MicroMag firmware supports two options for capacity control staging:

Options	Description
Lockout Alarm	The last four safety/lockout alarms have additional runtime data saved. The runtime data saved is the value of every input/output/state point for the last 30 second prior to the safety/lockout.

14.6. MicroMag Chiller - Control On

The MicroMag firmware supports two capacity control staging:

Options	Description
Entering Temperature	Hardwired input temperature sensor
Leaving Temperature	Hardwired input temperature sensor

14.7. MicroMag Data Trending

The MicroMag firmware supports the storage of ALL INPUTS & OUTPUTS for trending both Static and Dynamic.

Options	Description
Static Trending	<p>The MicroMag supports Static Trending as follows:</p> <ul style="list-style-type: none"> • The most current 300 samples • Selective sample time. (At Config time or real time via MCS-Connect) • Use MCS-Connect to retrieve the Static Trending data and plot in graph format.
Dynamic Trending	With MCS-Connect you can select Dynamic graphing. (Sec. by Sec.)

14.8. MicroMag Compressor Types

The MicroMag firmware supports the following:

Options	Description
Compressors	<ul style="list-style-type: none">• Up to 6 Compressors, compressor types supported:• Fixed Scroll.• Digital Scroll,• VFD Scroll,• Multi-Stage Comp with Up to 4 stages per compressor for Loaders or Unloaders• Anti-Cycle. set points, OFF to ON and ON to ON are provided. (On to ON regulates the maximum number of starts per hour the compressor can have)• Cooling is enabled when the Chilled Water temperature rises above the set point plus the control zone.• Additional digital scrolls can be controlled by adding an MCS-DIGITAL-SCROLL-INTERFACE for each Digital Scroll controlled via an Analog Output from the MicroMag.

Chapter - 15. MCS-CONFIG

The following options are specified in MCS-Config when building the configuration for the controller. These options are used by the MCS or an OEM to customize the system to meet the individual control requirements.

15.1. SETUP SCREEN

- Control method is based upon a control zone.
- The control temperature sensor can be either the Entering or Leaving sensor.
- Condenser control maintaining sufficient discharge superheat for good oil separation.
- Anti-cycle timers (OFF to ON and ON to ON).
- Maximum of 6 circuits per MicroMag, with selectable compressor rotation.
- Warning RO (turned on for low suction unload, high discharge unload, etc.).
- Alarm RO (turned on whenever an alarm is generated).
- Optional auto rotation for compressors.
- Low and/or high ambient temperature shut down.

Setup number of Relays Outputs, Analog Outputs and Sensor Inputs

The screenshot displays the 'MicroMag-V18 Setup Screen' with the following sections and settings:

- Default LCD Display:** UNIT STATUS
- Default Display Point:** (empty)
- Display Units:** Deg F / PSI
- Max Lockout Resets per Day:** 6
- Auth Level Bypass:** Factory Level
- History Sample Rate (Seconds):** 5
- Total Number of RO's:** 16
- Total Number of AO's:** 0
- Total Number of SI's:** 26
- MCS-Thermostat:** Yes (radio button), No (radio button)
- Number of SI Boards:** Auto (radio button), Zero (radio button), One (radio button), Two (radio button)
- Daylight Savings Time:** Active (radio button Yes, radio button No), DOW: Sunday, Hour: 1
- Spring Forward Month:** March
- Spring Forward Begin Date:** 8
- Spring Forward End Date:** 14
- Fall Back Month:** November
- Fall Back Begin Date:** 1
- Fall Back End Date:** 7
- RS485 Communication #1:** MCS Protocol Address: 1, Protocol Type: MCS, Baud Rate: 19200
- RS485 Communication #2:** MCS Protocol Address: 1, Protocol Type: MCS, Baud Rate: 19200
- RS485 Config-Loss of BMS Communication:** Network Run/Stop Default: No Change (radio button), Network Schedule Default: Schedule (radio button)
- System Graphic Information:** Name of Graphic .xml or .html file: systemoverviewcooling.xml

Name of Graphic File used on touchscreen

15.1.1 DEFAULT LCD DISPLAY

- Scrolling Info LCD Display: When setup in the configuration file, the LCD will continue to display the status points of the controller you are viewing. After pressing a button, the scrolling will pause for 15 minutes before it continues.

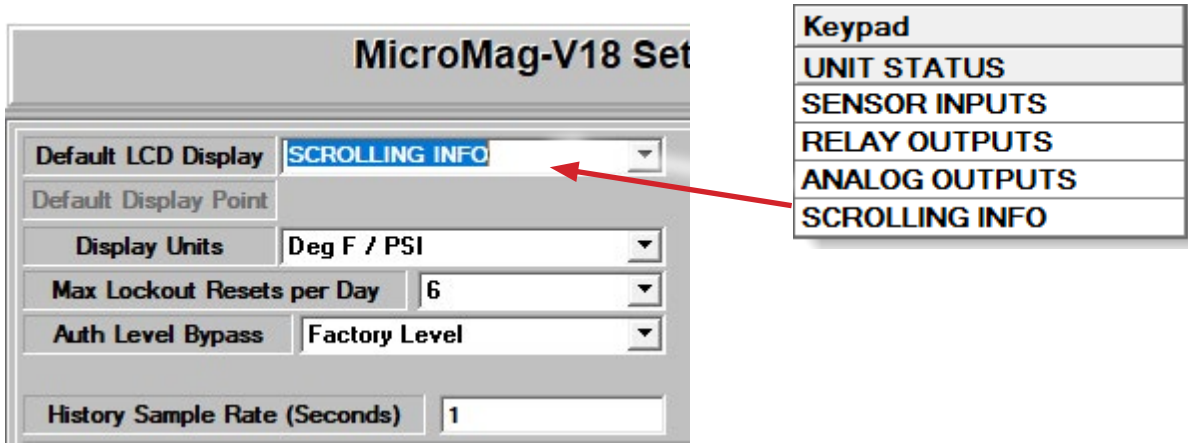

15.1.2 SETUP EXPANSION BOARDS / THERMOSTAT

Section shows the total number of RO's, AO's and SI's used including all expansion boards.

Spare keys above allows the user to clear the contents of a row in the ROs, AOs, & SIs screen.

- MCS-THERMOSTAT - click YES if you have a MCS-THERMOSTAT installed in your system

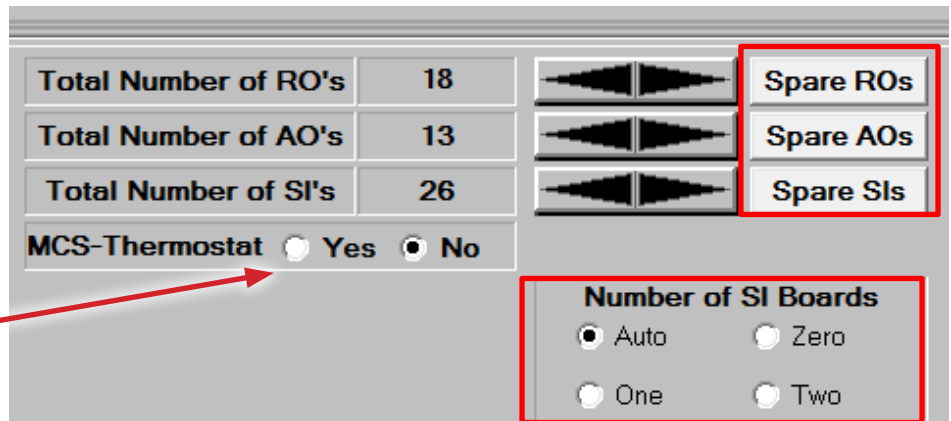

15.1.3 DAYLIGHT SAVING TIME

Setup for entering Daylight saving time.

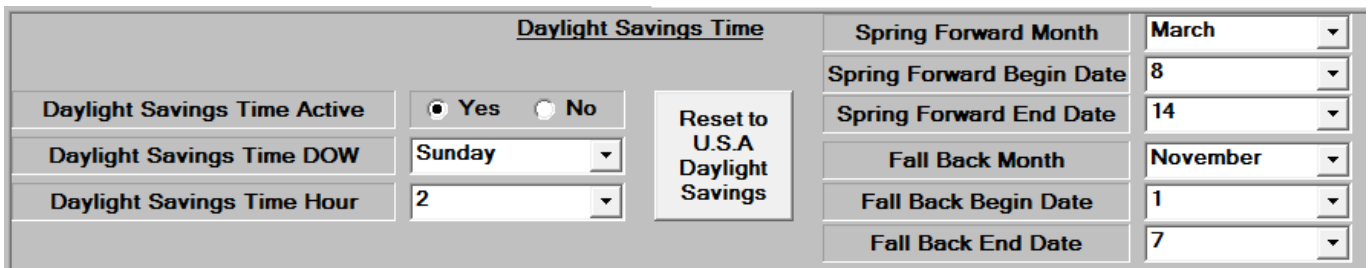

15.2. MicroMag MCS-Config

The MicroMag control is a function of the items selected during construction of the MCS-CONFIG. Shown below is the MicroMag Chiller Information Screen.

15.2.1 General Info

The sensors are selected that will control the following mode:

-Chiller

The screenshot displays the 'MicroMag-V18 Information Screen' with the 'Chiller' mode selected. The interface is divided into several sections:

- Information Panel Selector:** Radio buttons for 'Chiller' (selected), 'RTU', and 'AHU'.
- General Information:**
 - Control On:** Radio buttons for 'Entering Temp' and 'Leaving Temp'.
 - Unit Sensors:** Dropdowns for 'Entering Temp.' (Not Used), 'Leaving Temp.' (ChwOutTemp), 'Flow Switch' (CHW FLOW), and 'Outside Temp.' (Not Used).
 - Unit Power:** Dropdown for 'Phase Loss' (Not Used).
 - Unit Control:** Dropdowns for 'Run/Stop Switch' (RUNSTOP SW) and 'Emergency Stop Switch' (Not Used).
 - Unit Indicators:** Dropdowns for 'Warning Relay' (Not Used) and 'Alarm Relay' (ALARM).
 - Schedule Control:** Radio buttons for 'Occupation State' and 'On/Off'.
 - Target Reset Sensors:** Dropdowns for 'Cooling Target Reset' (TARG RESET), 'Heating Target Reset' (Not Used), and 'Reheat Target Reset' (Not Used).
- Chiller Information:**
 - Number of Compressors: 4
 - Refrigerant Type: R410A
 - Number of Steps: 4
 - Pre-Pump Out: Radio buttons for 'Yes' and 'No'.
 - Last Stage to 100% (Override Setpoint): Radio buttons for 'Yes' and 'No'.
 - Wanted %-Starting Next Compressor: Radio buttons for 'Calculated %' and 'Use Min %'.
 - Preemptive Chiller Staging Logic: Radio buttons for 'Always Active' and 'Off When Fixed Stages'.
- Pump Information:**
 - Chiller Pump Relay #1: Not Used
 - Chiller Pump Relay #2: Not Used
 - Process Control:**
 - Pump RO: Not Used
 - Pump AO: Not Used
 - Pump Input SI: Not Used
 - Pump Output SI: Not Used
 - Pump Fault SI: Not Used

The following info and sensors can be selected:

- Control On - Entering Temp or Leaving Temp
- Unit Power – Phase loss Input.
- Unit Control – RUN/STOP Input.
- Unit Indicators - Warning Relay, Alarm Relay
- Schedule Control - Occupation State, On/Off
- Target Reset Sensors, Cooling Target Reset, Heating Target Reset, Reheat Target Reset
- Chiller Information, # of Compressors, Refrigerant Type, Number of Steps, Pre Pump Out, etc.
- Pump Information, Process Control

Chapter - 16. MCS-CHILLER CONTROL STATES

The MicroMag controller is a state computer, that is, decisions are made based upon Set points, timers and Sensor Inputs, the controller moves from one state to another. The controller will change states to ensure the proper functioning of the chiller package.

As we review the various states, we must remember that a chiller package consists of a number of different parts or functions: the compressors and their related items such as unloaders hot gas bypasses, etc.; evaporator; and condensing functions.

Both the Capacity Control States and Compressor Control States are displayed in the Status screens on the Keypad Display. To view the state of the chiller, select the Status option from the menu on the Keypad. You can then view the entire status by using the page up / down function keys. The information can also be accessed through MCS-Connect under status screen by clicking on the CONTROL STATUS button.

16.1. MICROMAG UNIT STATES

- **PowerUpDelay** - This is a power up delay before starting to run the algorithm, hard coded 60 seconds. In this state all Relay Outputs are turned off. This time delay is to insure the microprocessor has stable power before starting the algorithm.
- **MCS IO FAILED** - This state will be entered whenever the MicroMag loses communications with any of the I/O boards that are connected through the MCS I/O network. When this state is entered the MicroMag will generate an MCS I/O offline alarm, which identifies which I/O is offline and a lost I/O shutdown alarm which locks out the unit. Once locked out, if there are ten consecutive successful I/O reads the MicroMag will reset and attempt to run. When this occurs a "LOST I/O RESTART" will be generated. Or, the lockout-reset key can be pressed to reset the MicroMag, after the lost I/O has been corrected. This will generate a "LOCKOUT RESET." In this state all RO's except ALARM and OIL HEATER are turned OFF.
- **MACHINE LOCKOUT** - This state is entered whenever a critical situation is encountered that could cause harm to the chiller package. Items such as freeze protect and emergency stop will force the system into this state. Lockouts can be reset without authorization from the keypad or MCS-Connect program; however if the lockout condition has not been corrected, the system will again be forced into the LOCKOUT state. In this state, all RO's except ALARM and OIL HEATER (for screws with an oil pump) are turned OFF and placed in the "LOCKOUT" state. Note: If the Lockout Reset is pressed more than the programmed allowable number of times in one day the unit cannot be reset during the current day except through MCS-Connect and requires Factory authorization. This number is selected from a drop down menu under the Setup Information button in MCS-Config. Close Vane RO will stay energized for 5 minutes after compressor lockout.
- **OFF SMOKE ALARM** - This state is entered when a smoke alarm has been detected. In the MCS-Configuration file the Smoke Alarm Indicator must be selected in the General Information panel under the MAGNUM screen. When this sensor is trips, an error message "OFF-SMOKE ALARM" is generated and the unit state is changed. In this state all RO's except ALARM and OIL HEATER are turned OFF.
- **OFF SCHEDULE** - This state is entered when the schedule is calling for the package to be off. When the chiller is in this state, the individual compressor states if active are moved to the CMP IS OFF state through the normal states. One capacity STEP will be moved per second.
- **OFF DEMAND** - The Unit is off based on no current load
- **OFF RUN/STOP** - This state is entered when the run stop switch is off, in the stop position. When the chiller is in this state, the individual compressor states if active are moved to the CMP IS OFF state through the normal states. One capacity STEP will be moved per second.
- **DIRECT SUPERVISOR** - The Unit is under supervised mode

- **COOLING** - When the sensor of the Cooling Mode is below the value of Setpoint #8, Chilled Water Target, the mode will be set to COOLING MODE.

16.2. COMPRESSOR STATES

All User Logic points can now access the Compressor Control State. The action of the compressor control states may result in an increase or decrease in capacity. The Unit Control States may affect or change the Compressor Control States or supersede them altogether.

- **LOST IO** - This state is entered when the Capacity Control state is NO RUN- I/O LOST. Resetting the lockout will move the compressor to the CMP OFF/READY state.
- **SAFETY TRIP** - This state is entered when a safety trip occurs but a lockout is not generated. An alarm is generated but the system will automatically restart after the delay specified in the corresponding Setpoint. If a second trip occurs within the time specified in the Setpoint, the compressor will be placed in the CMP LOCKED OUT state.
- **LOCKOUT** - This compressor has been locked out. (From lost IO, multiple safety trips of same type within 2 hours, etc)
- **DISABLED** - The compressor has been disabled. (Disable switch has been turned on)
- **OFF:LowAmb** - The compressor is off based on low ambient
- **PUMPDOWN** - The compressor is in PUMP DOWN state, either at startup or shutdown
- **ANTI CYCLE** - The compressor is off and in anti cycle mode. (Setpoint #40 & #41 provide off to on and on to on. On to on provides control for number of cycles per hour.)
- **OFF&READY** - The compressor is off and ready to run. It must be in the off and ready to run for a minimum of 1 minute
- **START-UP** - This compressor is in startup mode. Startup is a function of the compressor type.
- **RUNNING** - This compressor is running
- **DEFROSTING** - This compressor is in a defrost cycle
- **SucPsiHOLD** - The compressor is in a suction psi hold
- **SucPsiUNLD** - The compressor is in a suction unload condition
- **DisPsiUNLD** - The compressor is in a discharge pressure unload
- **DisPsiHOLD** - The compressor is in a discharge pressure hold
- **UNLD LOTMP** - Not implanted
- **HOLD LOTMP** - Not implanted
- **HOLD HIAMP** - The compressor is holding based on high ampere draw
- **DIS TMPHLD** - The compressor is holding based on high discharge temperature
- **HOLD HIWTR** - Not implanted
- **UNLD HIAMP** - The compressor is unloading due to current high amps

- **UNLD HITMP** - Not implanted
- **HOLD HITMP** - Not implanted
- **DIS TmUNLD** - The compressor is unloading based on current high discharge temperature
- **DisSh UNLD** - The compressor is unloading based on high discharge superheat
- **DisSH HOLD** - Not implanted

16.3. CONDENSER STATES

- **COND INIT** - The condenser is in initialization state
- **UNLOADING AZ** - We are above the zone and unloading (ROC)
- **LOADING AZ** - We are above the zone and loading (normal)
- **HOLDING AZ** - We are above the zone and holding (ROC)
- **UNLOADING BZ** - We are below the zone and unloading (normal)
- **LOADING BZ** - We are below the zone and loading (ROC)
- **HOLDING BZ** - We are below the zone and holding (ROC)
- **UNLOADING IZ** - We are in the zone and unloading (ROC)
- **LOADING IZ** - We are in the zone and loading (ROC)
- **HOLDING IZ** - We are in the zone and holding (normal)
- **UNLD ROC** - We are unloading based on ROC
- **LOAD ROC** - We are loading based on ROC
- **HOLD ROC** - We are holding based on ROC
- **DISABLED** - The condenser is disabled
- **NO FLOW** - The unit is off because there is no flow
- **LOCKED OUT** - The condenser is locked out
- **COND OFF** - The condenser is off

16.4. PUMP STATES

- **PIMP INIT** - Pump I in unitization mode
- **PUMP ON** - Pump is on
- **PUMP OFF** - Pump is off
- **PUMP SUPER** - Pump is in supervisor mode

16.5. COOLING STATES

- **COOL INIT** - Cooling is in initialization mode
- **UNLOADING AZ** - Control sensor is above the zone, the capacity control is unloading because the rate of change (ROC) is dropping too quick and we could overshoot the control zone (ie ROC value is less than 2x min ROC setpoint)
- **LOADING AZ** - Control sensor is above the control zone and rate of change is not dropping quick enough so capacity control is loading.
- **HOLDING AZ** - Control sensor is above the control zone and rate of change(ROC) is dropping quick enough (Min ROC setpoint) so the capacity control is holding.
- **UNLOADING BZ** - Control sensor is below the control zone, the capacity control is unloading because the rate of change (ROC) is not increasing quick enough .
- **LOADING BZ** - Control sensor is below the control zone and rate of change is rising too quick so capacity control is loading.
- **HOLDING BZ** - Control sensor is below the control zone and rate of change(ROC) is rising quick enough.
- **UNLOADING IZ** - Control sensor is in the zone, the capacity control is unloading because the rate of change (ROC) is dropping too quick.
- **LOADING IZ** - Control sensor is in the control zone and rate of change is rising too quick so capacity control is loading.
- **HOLDING IZ** - Control sensor is in the control zone and the Rate of Change is low.
- **OFF & READY** - The cooling is off but ready to run.
- **DISABLED** - The cooling is disabled, during power up, during smoke alarm, run/stop switch is off
- **NO FLOW** - The cooling is off because there is no flow.
- **LOCKED OUT** - The cooling is locked out on safety.
- **SUPERVISOR (BMS)** - BMS controls the staging.

16.6. EXV STATES

The EXV Control States show the status of the compressor’s expansion valve. If the compressor has an EXV it will be displayed under the Status entry.

System Status								
Unit State	Time							
PUMP ONLY	00:20:26							
Pump State	Pump Time							
PUMP ON	00:00:00							
Capacity State	Capacity Time	Stages Wanted/Active	Target	Control On	Wanted %	ADJ Delay	Rate of Change	
NO FLOW	00:20:48	0/0	45.0F	ChwOutTemp= 45.0F	----	----	0.0F	
Compressor State	Compressor Time	FLA %	Saturated Suction	Suction Superheat	Saturated Condenser	Disc Superheat	Oil Differential	Lead?
DISABLED	00:20:26	0	44.1	15.9	107.0	48.0	222.0P	Yes
DISABLED	00:20:26	0	44.1	15.9	107.0	48.0	222.0P	
DISABLED	00:20:26	0	-40.0	40.0	-40.0	40.0	0.0P	
DISABLED	00:20:26	0	-40.0	40.0	-40.0	40.0	0.0P	
EXV State	Time	Valve %	Control On Suct. Supht	SuperHeat ROC	ADJ Delay			
EXV CLOSED	00:47:25	0	15.9F	0.0F	60			
EXV CLOSED	00:47:25	0	40.0F	0.0F	60			
Condenser State	Condenser Time	Stages Wanted/Active	Target	Control On	Wanted %	ADJ Delay	Rate of Change	
COND OFF	00:47:23	0/0	300.0P	DISC 1 PSI= 350.0P	----	0	0.0P	

- **EXV CLOSED** - The associated compressor is OFF and the valve is closed
- **EXV COMP PRE-PMPDWN** - The valve has been in a closed state and the system is now requiring the valve action.
- **EXV IS HOLDING** - Superheat is in control zone and ROC is acceptable.
- **EXV COMP STARTUP** - At startup the valve will remain in this state for the time in Setpoint #133. At that time the state will be changed to holding, at this point the valve control logic will position the valve. AT 100% This state will be entered when the valve opening reaches 100%.
- **EXV IS OPENING** - Superheat is in control zone but rising too fast, ROC less than 1.0.
- **EXV IS CLOSING** - Superheat is in the control zone and the rate of change is acceptable, ROC greater than -0.5.
- **EXV LOW SUPERHEAT** - Force a course valve adjustment.
- **EXV OPENING 4x** - Superheat is above control zone.
- **EXV OPENING 2x** - Superheat is in control zone but rising too fast, the ROC is greater than 1.0.
- **EXV LOW SUCT OPEN 1X** - State indicates that a low suction pressure condition exists.
- **EXV CLOSING 2x** - Superheat is in the control zone and the rate of change is acceptable, the ROC is less than -0.5 and greater than -1.0.
- **EXV CLOSING 4x** - Superheat is in control zone but falling too fast, ROC less than -1.0.
- **EXV MOP CLOSING** - Maximum operating pressure option is active and it is forcing the EXV to close. In this state the EXV valve's opening will be reduced.
- **EXV MOP HOLDING** - Maximum operating pressure option is active and it is forcing the EXV to hold.

16.7. EXV LOGIC

16.7.1 EXV TARGET (Setpoint #132)

#	Name	Value	Min	Max	Adjust Value	Time (SEC)	Max Time Allowed (SEC)	Lockout Delay (HRS)	Safety Down Time(MIN)	Active or Non-Active	Select Value: # decimals & print char	
131	SPARE STPT	0	0	0	0	---	---	---	---	Non-Active	...	Spare
132	EXV TARGET	12	6	20	0.1	---	---	---	---	Active	...	TEMP
133	EXV ADJUST	60	30	90	1	---	---	---	---	Active	...	SECONDS
134	EXV LO SPRHT	2	1	5	0	---	---	---	---	Active	...	TEMP
135	EXV MOP TARG	175	170	350	1	---	---	---	---	Active	...	PSI GAGE

- **EXV control** is bases on superheat. Value is the target the MicroMag Chiller will control from.
- **Zone:** is the dead band around the superheat target.
- **Max Roc Value:** The max Roc that the EXV control will allow to determine opening or closing of the EXV.
- **ROC Interval:** The time interval the Roc is calculated over.
- **Adjust Mult/Div:** Scales any calc. changes to EXV value based on controlling SI'S proximity to the target.

#	Name	Zone Value	Zone MIN	Zone MAX	MAX ROC Value	MAX ROC MIN Limit	MAX ROC MAX Limit	ROC Interval Value	ROC Interval MIN Limit	ROC Interval MAX Limit
131	SPARE STPT	---	---	---	---	---	---	---	---	---
132	EXV TARGET	1	0.5	2	0.2	0.2	2	4	3	10
133	EXV ADJUST	---	---	---	---	---	---	---	---	---
134	EXV LO SPRHT	---	---	---	---	---	---	---	---	---
135	EXV MOP TARG	5	1	10	0	0	0	10	5	60

16.7.2 EXV ADJUST (Delay) (Setpoint #133)

- Determines how quickly to adjust the EXV valve percentage. The farther the superheat is from the target the quicker the step delay will work to reach setpoint.
- **Min Adjust % Valve:** EXV value % will not be adjusted greater than this value.
- **Max Adjust Valve %:** EXV valve % will not be adjusted greater than this value.
- **Min Cap %:** EXV min % position.
- **Max Cap %:** EXV max % position.
- **Delay M/O:** Scales calc changes to EXV step delay.

16.7.3 EXV LOW SUPERHEAT (Time) (Setpoint #134)

- If calculated superheat remains below the value set in this setpoint a safety trip occurs.

16.7.4 EXV MOP (Maximum operating pressure) TARGET (Setpoint #135)

- Value is maximum suction PSI that EXV control will allow before closing off valve.
- **Zone:** Dead band around target PSI.
- **ROC:** Setting are the same.
- **Adjust M/O:** Scales calculation changes to EXV % based on MOP target controlling PSI's proximity.

16.8. HGB_CONTROL (STPT #143)

This new setpoint is available on MicroMag V18 only, starting on the released V18.00 F

The setpoint **HGB_CONTROL** (STPT #143) is an offset to control the HGB RO base on temperature.

HGB_CONTROL has to be set as Target Type, and the Select Value in TEMP

#	Name	Value	Min	Max	Adjust Value	Time (SEC)	Max Time Allowed (SEC)	Lockout Delay (HRS)	Safety Down Time(MIN)	Active or Non-Active	Select Value: # decimals & print char
143	HGB CONTROL	-1.5	-5	0	0.1	---	---	---	---	Active	TEMP

#	Name	Zone Value	Zone MIN	Zone MAX	MAX ROC Value	MAX ROC MIN Limit	MAX ROC MAX Limit	ROC Interval Value	ROC Interval MIN Limit	ROC Interval MAX Limit	Adjust Multiplier Value	Adjust Divider Value
143	HGB CONTROL	-1.5	-5	0	0	0	0	1	1	1	1	1
144	PrcsPumpTarg	0	0	0	0	0	0	1	1	1	1	1

The Value needs to be enter in negative number, to set the offset to turn on the HGB RO

If the cooling_target_SI is less than the cooling target setpoint plus the HGB_CONTROL value, the HGB RO will turn ON .

The Zone value will set the offset to turn off the HGB RO

If the cooling_target_SI is greater than the cooling target setpoint plus the HGB_CONTROL zone value, the HGB RO will turn OFF.

If the LLSRO is OFF the HGB RO will be OFF as well

16.9. Variable Speed Process Pump Control

Firmware UMAG 18.00Gg (Chiller)

Setpoints #144 and #145 must be active for variable speed control. The pump can be controlled to either a pressure differential or to a temperature. If only using on/off pump control please make these two setpoints inactive and only point to the process pump RO.

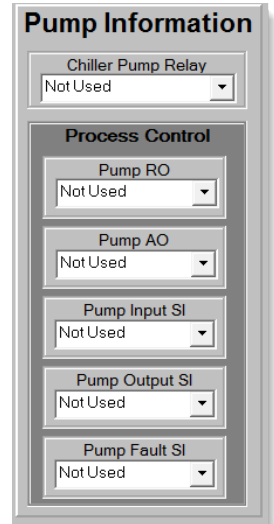

16.9.1 Setpoint #144 PrcsPumpTarg— (Target Type)

Value field - represents the target to control to.

Zone Value – Zone built around target

MAX ROC Value – Compares the control value rate of change. Maximum positive & negative Rate of Change allowed before preventing the pump from unloading or loading. If the ROC is greater than this value the pump state is set to HOLDING.

ROC Interval Value – Amount of time in seconds to look at the ROC.

Adj Mult/Div – Changes how aggressive the changes are to the wanted % each time capacity changes.

- This setpoint must have the correct “Select Value: # decimals & print char” selected. If you’re controlling to temperature you must select “TEMP”. If you’re controlling to PSI you must select “PSI GAGE” or “PSI ABS”.
- For pressure differential you must have both an input and output sensor selected under the process control section in config.
- For temperature control you will place the controlling sensor in the “Pump Input SI” box and leave the “Pump Output SI” box to “Not Used”

16.9.2 Setpoint #145 PrcsPump ADJ (Delay Type)

Value field - represents the time delay between adjustments to the AO

Min ADJ % - Minimum adjust allowed to capacity changes.

Max ADJ % - Maximum adjust allowed to capacity changes.

Min Capacity% - Indicates the minimum speed allowed. This is also the speed set when the pump is first turned on.

Max Capacity% - Indicates the maximum speed allowed.

Adj Mult/Div – Changes how aggressive the changes are to the process pump step delay count down.

Screen shot from MCS-CONNECT

Proc. Pump State	Proc. Pump Time	Stages Wanted/Active	Target	Control On	Wanted %	ADJ Delay	Rate of Change
HOLD ROC	00:00:14	1/1	70.0P	Differential= 10.0P	0	0	10.0P

16.10. Chilled Water Pump Control

Config version - 18.01W or greater
 Firmware version - 18.00M or greater

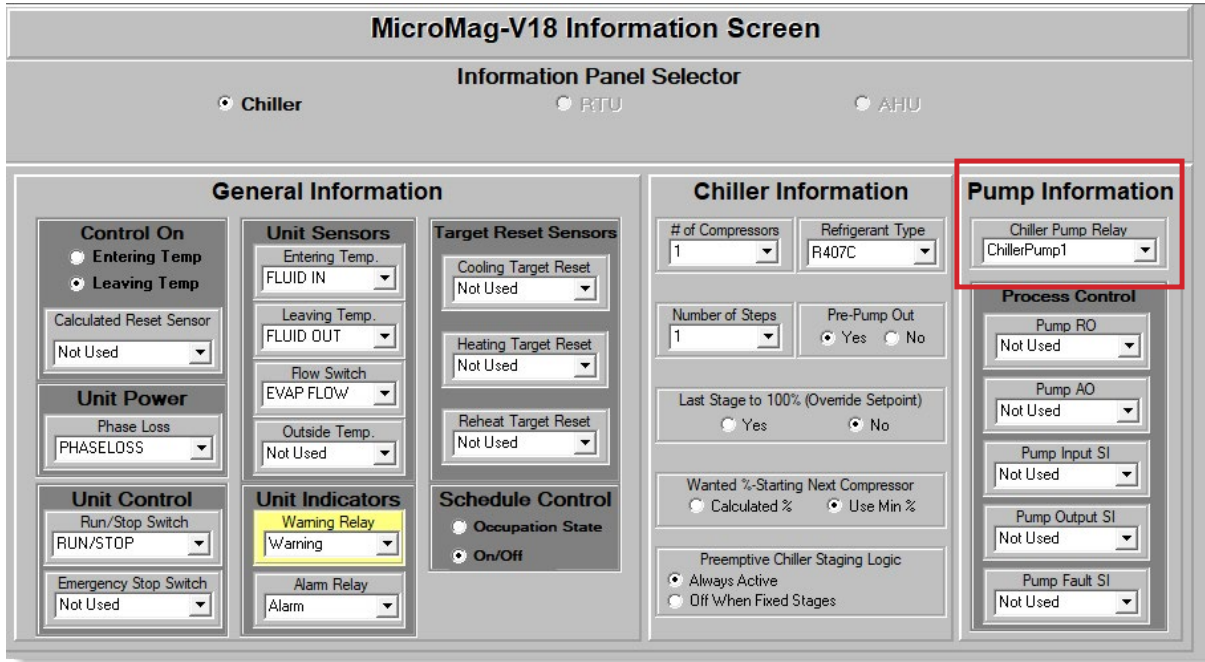

The current Micromag software version uMAG 18.00M or greater will support lead/lag chill water pump control with rotation logic.

Setpoint #120 and **Setpoint #149** are used with this control logic.

- If Setpoint #120 “NO FLOW” is active, flow is lost for the period of time contained in the ‘Value’ field, and only one pump is present, then the system will move to a LOCKED OUT state. If the system has two pumps and flow is lost, then the backup pump will start and the lead pump will be locked out. A Lockout Reset will be required to restart the system or to reactive a locked out pump.
- If Setpoint #120 is inactive and the flow is lost, the system will move to the ‘NO FLOW’ state. When flow is returned the system will automatically restart, no reset is required.

Setpoint #149 “LEADPMPROTAT” indicates whether the rotation option is active or which pump is the lead pump.

If **Setpoint #149 value** is zero, then rotation of the pumps will occur whenever the lead pump is turned off. If no pump rotations have occurred within the amount of days specified in the zone field the controller will shut down the chiller and do a forced pump rotation at midnight the day a forced rotation takes place on. If the zone field is 0 no forced rotation will take place.

If **Setpoint #149 value** is non-zero, then rotation of the pumps is inactive and the value will specify the lead pump. This Setpoint can be changed in a live unit and the appropriate action will be taken.

Zone – Determines the number of days in between a forced pump rotation if no automatic rotations have occurred.

Setpoint Information Screen (MicroMag-V18)														
#	Name	Value	Min	Max	Adjust Value	Time (SEC)	Max Time Allowed (SEC)	Lockout Delay (HRS)	Safety Down Time(MIN)	Active or Non-Active	Select Value: # decimals & print char	Level Of Auth. To Display	Type of Setpoint	
120	NO FLOW	10	1	15	1	---	---	---	---	Active	...	SECONDS	View Only	Setpoint
149	LEADPMPROTAT	0	0	2	1	---	---	---	---	Active	...	Spare	View Only	Target
#	Name	Zone Value	Zone MIN	Zone MAX	MAX ROC Value	MAX ROC MIN Limit	MAX ROC MAX Limit	ROC Interval Value	ROC Interval MIN Limit	ROC Interval MAX Limit	Adjust Multiplier Value	Adjust Divider Value		
149	LEADPMPROTAT	1	0	5	0	0	0	1	1	1	1	1		

Chapter - 17. MCS-CHILLER STARTUP SEQUENCE

17.1. Power Up

If the unit is not in a Lockout condition, it will start in the Power Up stage. After completing this stage the water pump will be started. Once the water pump starts, no other functions can be initialized until water flow has been established and the minimum supply startup time,60 seconds has elapsed.

17.2. Operational Modes

Cooling mode is selected at configuration time.

The following are ways to initiate the Occupied Mode of operation for the MicroMag Controller:

- Internal week schedule
- Push button Override on a Zone Temperature Sensor(MCS-Thermostat)
- Remote Forced Occupied contact closure
- BMS written Forced Occupied

17.2.1 UNOCCUPIED OPERATION

Night Setback values are used for Cooling.

17.2.2 SCHEDULING

Has an internal clock that provides 7 days and 1 holiday scheduling with 2 start/stops per day.

Allows scheduling of up to 8 holiday periods per year.

Cooling: is initialized after unit water flow has been established. The cooling pre-delay time is specified and must be satisfied before continuing.

Off: The unit mode will be off when the unit RUN/STOP indicates a stop.

17.2.3 Cooling Mode

When the temperature enable sensor rises above the cooling set point the cooling status will be enabled. The configuration may allow a delay before the cooling output is energized. Cooling will continue to run provided the safeties of the cooling Set Points are satisfied and the temperature enable set point has not been achieved. Note: If the Mode Enable and the Cooling Target sensor are both being used the Cooling Target set point will be utilized as Mode Enable.

17.2.4 Capacity Control

Cooling capacity will be controlled by the difference between the cooling target and the cooling control temperature. Loading of the compressor will continue until it reaches 100%. The amount of temperature difference between the cooling temperature set point and the actual sensor temperature will determine the compressor loading (Rate of Change). The greater the difference, the more aggressive the loading time will be. The configuration settings will allow you to control multiple compressors.

17.2.5 Condenser Fan

While the system is in the cooling mode and the discharge pressure exceeds the Condenser Target PSI Set Point the condenser fan will operate based on the configuration. The condenser fan can be set up with a combination of Analog and Relay Output configurations.

18.1. BACnet Properties

Bacnet Property	AI	AV	AO	BO	MSV
PROP_OBJECT_IDENTIFIER	X	X	X	X	X
PROP_OBJECT_NAME	X	X	X	X	X
PROP_DESCRIPTION	X	X	X	X	X
PROP_OBJECT_TYPE	X	X	X	X	X
PROP_PRESENT_VALUE	X	X	X	X	X
PROP_STATUS_FLAGS	X	X	X	X	X
PROP_EVENT_STATE	X	X	X	X	X
PROP_OUT_OF_SERVICE	X	X	X	X	X
PROP_UNITS	X	X	X	X	
PROP_RELINQUISH_DEFAULT			X	X	
PROP_PRIORITY_ARRAY			X	X	
PROP_NUMBER_OF_STATES					X
PROP_STATE_TEXT					X

AI = Analog Inputs

AV = Analog Value

AO = Analog Outputs

BO = Binary or Relay Outputs

MSV = Multi State Values

18.2. MICROMAG PROTOCOLS

1. MCS PROTOCOL

2. MODBUS RTU PROTOCOL

3. BACnet MS/TP PROTOCOL

The RS-485 address can be verified and changed (with the proper authorization code) from the keypad/LCD.

The following steps will display the RS-485 Network address, and the Baud Rate:

- Press the Menu key, select Service Tools, and then press the Enter key.
- Select RS485 Network then press Enter.
- Select Protocol then press Enter. Change the protocol: **MCS PROTOCOL, MODBUS RTU, or BACnet.**
- Select address then press Enter. Change the address then press Enter.
- Select Baud then press Enter. Set the baud rate then press Enter.
- Connect the communication wires to the TX RS485 three position portion of the six position terminal block located above the display.

18.2.1 BACNET PROTOCOL DEVICE ID

The BACnet DEVICE ID is a five-digit number. The first three digits are based on our BACnet vendor ID 181, and the last two are set by the BACnet/MS/TP address.

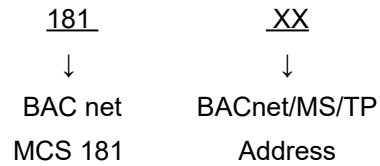

The BACnet address can be verified and changed (with the proper authorization code) from the Keypad/Display. The following steps will display the BACnet MS/TP Network address, and the Baud Rate:

- Press the Menu key, select Service Tools, and then press the Enter key.
- Select RS485 Network then press Enter.
- Select Protocol then press Enter. Change the protocol to BACnet protocol.
- Select BACnet ID then press Enter. Change the ID then press Enter.
- Select Baud then press Enter. Set the baud rate then press Enter.

18.2.2 Network inputs to MicroMag

The MicroMag can receive changes from the network to enable or disable the Network Run/Stop & Network Target Reset.

The MicroMag has a large number of Setpoints that can be written to or from the BMS. They are identified in the Setpoint BMS Points Writable chart found later in this section.

Net Run/Stop – Does not need a virtual SI or to be pointed to it.

Net OCC SW- Can write 4 values:

0 = Unoccupied

1 = Occupied

2 = Override: Puts unit into override amount of time in specified in the Setpoint. Only needs to write 2 for a few seconds to force override, then it writes to a 1.

3 = Schedule: Uses schedule input in MicroMag.

18.3. BMS Sensor Input Points

Sensor numbering is based upon the MicroMag or MCS-SI hardware type board, Notable BACnet properties available: MicroMag supports up to 42 sensor Inputs. Refer to points lists for BACnet Naming.

The **Assumed Decimal** column changes depending on the Display Type of the sensor.

MICROMAG	BACnet ID		MODBUS RTU	
	PT#	BACnet ID	Name	Register
Sensor M-1	AI:1	Refer to Config	30001	1
Sensor M-2	AI:2	Refer to Config	30002	1
Sensor M-3	AI:3	Refer to Config	30003	1
Sensor M-4	AI:4	Refer to Config	30004	1
Sensor M-5	AI:5	Refer to Config	30005	1
Sensor M-6	AI:6	Refer to Config	30006	1
Sensor M-7	AI:7	Refer to Config	30007	1
Sensor M-8	AI:8	Refer to Config	30008	1
Sensor M-9	AI:9	Refer to Config	30009	0
Sensor M-10	AI:10	Refer to Config	30010	0
Sensor 1-1	AI:11	Refer to Config	30011	0
Sensor 1-2	AI:12	Refer to Config	30012	0
Sensor 1-3	AI:13	Refer to Config	30013	0
Sensor 1-4	AI:14	Refer to Config	30014	0
Sensor 1-5	AI:15	Refer to Config	30015	0
Sensor 1-6	AI:16	Refer to Config	30016	0
Sensor 1-7	AI:17	Refer to Config	30017	0
Sensor 1-8	AI:18	Refer to Config	30018	0
Sensor 1-9	AI:19	Refer to Config	30019	0
Sensor 1-10	AI:20	Refer to Config	30020	0
Sensor 1-11	AI:21	Refer to Config	30021	0
Sensor 1-12	AI:22	Refer to Config	30022	0
Sensor 1-13	AI:23	Refer to Config	30023	0
Sensor 1-14	AI:24	Refer to Config	30024	0
Sensor 1-15	AI:25	Refer to Config	30025	0
Sensor 1-16	AI:26	Refer to Config	30026	0
Sensor 2-1	AI:27	Refer to Config	30011	0
Sensor 2-2	AI:28	Refer to Config	30012	0
Sensor 2-3	AI:29	Refer to Config	30013	0
Sensor 2-4	AI:30	Refer to Config	30014	0
Sensor 2-5	AI:31	Refer to Config	30015	0
Sensor 2-6	AI:32	Refer to Config	30016	0
Sensor 2-7	AI:33	Refer to Config	30017	0
Sensor 2-8	AI:34	Refer to Config	30018	0
Sensor 2-9	AI:35	Refer to Config	30019	0
Sensor 2-10	AI:36	Refer to Config	30020	0
Sensor 2-11	AI:37	Refer to Config	30021	0

MICROMAG	BACnet ID		MODBUS RTU	
PT#	BACnet ID	Name	Register	#Assumed Decimal
Sensor 2-12	AI:38	Refer to Config	30022	0
Sensor 2-13	AI:39	Refer to Config	30023	0
Sensor 2-14	AI:40	Refer to Config	30024	0
Sensor 2-15	AI:41	Refer to Config	30025	0
Sensor 2-16	AI:42	Refer to Config	30026	0

18.4. BMS Relay Output Points

Sensor numbering is based upon the MicroMag or MCS-RO hardware type board Notable BACnet properties available. MicroMag supports up to 20 relay outputs. Refer to points lists for Bacnet Naming.

Assumed Decimal column for BO is always 0 but should match the print and grid shown in cfg and connect.

MICROMAG	BACnet ID		MODBUS RTU	
PT#	BACnet ID	Name	Register	#Assumed Decimal
Relay M-1	BO:1	Refer to Config	00001	0
Relay M-2	BO:2	Refer to Config	00002	0
Relay M-3	BO:3	Refer to Config	00003	0
Relay M-4	BO:4	Refer to Config	00004	0
Relay M-5	BO:5	Refer to Config	00005	0
Relay M-6	BO:6	Refer to Config	00006	0
Relay 1-1	BO:7	Refer to Config	00007	0
Relay 1-2	BO:8	Refer to Config	00008	0
Relay 1-3	BO:9	Refer to Config	00009	0
Relay 1-4	BO:10	Refer to Config	00010	0
Relay 1-5	BO:11	Refer to Config	00011	0
Relay 1-6	BO:12	Refer to Config	00012	0
Relay 1-7	BO:13	Refer to Config	00013	0
Relay 1-8	BO:14	Refer to Config	00014	0
Relay 1-9	BO:15	Refer to Config	00015	0
Relay 1-10	BO:16	Refer to Config	00016	0
Relay 2-1	BO:7	Refer to Config	00017	0
Relay 2-2	BO:8	Refer to Config	00018	0
Relay 2-3	BO:9	Refer to Config	00019	0
Relay 2-4	BO:10	Refer to Config	00020	0
Relay 2-5	BO:11	Refer to Config	00021	0
Relay 2-6	BO:12	Refer to Config	00022	0
Relay 2-7	BO:13	Refer to Config	00023	0
Relay 2-8	BO:14	Refer to Config	00024	0
Relay 2-9	BO:15	Refer to Config	00025	0
Relay 2-10	BO:16	Refer to Config	00026	0

18.5. BMS Analog Output Points

Sensor numbering is based upon the MicroMag or MCS-SI hardware type board Notable BACnet properties available. MicroMag supports up to 12 analog outputs. Refer to points lists for BACnet Naming.

Assumed Decimal for AO is always a 1 because an AO is a % from 0.0% to 100.0%

MICROMAG PT#	BACnet ID		MODBUS RTU	
	BACnet ID	Name	Register	#Assumed Decimal
M-T	AO:1	TRIAC SPARE	40001	1
Analog M-1	AO:2	Refer to Config	40002	1
Analog M-2	AO:3	Refer to Config	40003	1
Analog M-3	AO:4	Refer to Config	40004	1
Analog M-4	AO:5	Refer to Config	40005	1
Analog 1-1	AO:6	Refer to Config	40006	1
Analog 1-2	AO:7	Refer to Config	40007	1
Analog 1-3	AO:8	Refer to Config	40008	1
Analog 1-4	AO:9	Refer to Config	40009	1
Analog 2-1	AO:10	Refer to Config	40010	1
Analog 2-2	AO:11	Refer to Config	40011	1
Analog 2-3	AO:12	Refer to Config	40012	1
Analog 2-4	AO:13	Refer to Config	40013	1

18.6. BACnet MS/TP BMS Setpoints

MicroMag supports up to 200 setpoints. Refer to points lists for BACnet Naming.
The Assumed Decimals Column changes depending on the Display Type selected.

MCS-MICROMAG		BACnet MS/TP		MODBUS RTU	
PT#	Name	Object ID	Name	Register	#Assumed Decimal
1	COOL ENABLE	AV:1	STP#1-COOL ENABLE	41001	1
2	HEAT ENABLE	AV:2	STP#2-HEAT ENABLE	41002	1
3	DEH ENABLE	AV:3	STP#3-DEH ENABLE	41003	1
4	DehCmpMinOvr	AV:4	STP#4-DehCmpMinOvr	41004	1
5	CoolNiteStbk	AV:5	STP#5-CoolNiteStbk	41005	1
6	HeatNiteStbk	AV:6	STP#6-HeatNiteStbk	41006	1
7	Deh NiteStbk	AV:7	STP#7-Deh NiteStbk	41007	1
8	COOL TARGET	AV:8	STP#8-COOL TARGET	41008	1
9	CoolStepDely	AV:9	STP#9-CoolStepDely	41009	0
10	HEAT TARGET	AV:10	STP#10-HEAT TARGET	41010	1
11	HeatStepDely	AV:11	STP#11-HeatStepDely	41011	0
12	REHT TARGET	AV:12	STP#12-REHT TARGET	41012	1
13	RehtStepDely	AV:13	STP#13-RehtStepDely	41013	0
14	S-FanSpd %	AV:14	STP#14-S-FanSpd %	41014	2
15	S-FanSpd Dly	AV:15	STP#15-S-FanSpd Dly	41015	0
16	CL/HT PreDly	AV:16	STP#16-CL/HT PreDly	41016	0
17	CND TRGT PSI	AV:17	STP#17-CND TRGT PSI	41017	1
18	CND STEP DLY	AV:18	STP#18-CND STEP DLY	41018	0
19	EconAmbEnabl	AV:19	STP#19-EconAmbEnabl	41019	1
20	ECON MAX %	AV:20	STP#20-ECON MAX %	41020	1
21	HiCO2MinDmpr	AV:21	STP#21-HiCO2MinDmpr	41021	1
22	MIN DAMPER %	AV:22	STP#22-MIN DAMPER %	41022	1
23	DehSucTmpTrg	AV:23	STP#23-DehSucTmpTrg	41023	1
24	DIRTY FILTER	AV:24	STP#24-DIRTY FILTER	41024	1
25	EcoToMechDly	AV:25	STP#25-EcoToMechDly	41025	0
26	BldgStatcTrg	AV:26	STP#26-BldgStatcTrg	41026	2
27	BldgStatcDly	AV:27	STP#27-BldgStatcDly	41027	0
28	ExhFanMinRun	AV:28	STP#28-ExhFanMinRun	41028	0
29	SFanMin%Cool	AV:29	STP#29-SFanMin%Cool	41029	2
30	SFanMin%Heat	AV:30	STP#30-SFanMin%Heat	41030	2
31	HiBldgStatic	AV:31	STP#31-HiBldgStatic	41031	2
32	HI CO2 LEVEL	AV:32	STP#32-HI CO2 LEVEL	41032	0
33	HI CO2 ZONE	AV:33	STP#33-HI CO2 ZONE	41033	0
34	LoAmbCompOff	AV:34	STP#34-LoAmbCompOff	41034	1
35	HiAmbHeatOff	AV:35	STP#35-HiAmbHeatOff	41035	1
36	OVERRIDE	AV:36	STP#36-OVERRIDE	41036	0
37	LEAD COMPRES	AV:37	STP#37-LEAD COMPRES	41037	0
38	CompRotation	AV:38	STP#38-CompRotation	41038	0
39	COMP MIN RUN	AV:39	STP#39-COMP MIN RUN	41039	0
40	ACYC ON-ON	AV:40	STP#40-ACYC ON-ON	41040	0
41	ACYC OFF-ON	AV:41	STP#41-ACYC OFF-ON	41041	0
42	PMP DOWN PSI	AV:42	STP#42-PMP DOWN PSI	41042	1

MCS-MICROMAG		BACnet MS/TP		MODBUS RTU	
PT#	Name	Object ID	Name	Register	#Assumed Decimal
43	PmpDownDelay	AV:43	STP#43-PmpDownDelay	41043	0
44	SERVICE MODE	AV:44	STP#44-SERVICE MODE	41044	0
45	SftyUnldDely	AV:45	STP#45-SftyUnldDely	41045	0
46	SftyHoldDely	AV:46	STP#46-SftyHoldDely	41046	0
47	SftyUnldAdj	AV:47	STP#47-SftyUnldAdj	41047	1
48	CompStartup%	AV:48	STP#48-CompStartup%	41048	1
49	SPARE STPT	AV:49	STP#49-SPARE STPT	41049	0
50	CmpAdjustDly	AV:50	STP#50-CmpAdjustDly	41050	0
51	COMPR 1 FLA	AV:51	STP#51-COMPR 1 FLA	41051	1
52	COMPR 2 FLA	AV:52	STP#52-COMPR 2 FLA	41052	1
53	COMPR 3 FLA	AV:53	STP#53-COMPR 3 FLA	41053	1
54	COMPR 4 FLA	AV:54	STP#54-COMPR 4 FLA	41054	1
55	LOW AMP %	AV:55	STP#55-LOW AMP %	41055	1
56	HIGH AMP %	AV:56	STP#56-HIGH AMP %	41056	1
57	HiAmpUnldHld	AV:57	STP#57-HiAmpUnldHld	41057	1
58	NoCompProof	AV:58	STP#58-NoCompProof	41058	0
59	HI MOTOR TMP	AV:59	STP#59-HI MOTOR TMP	41059	1
60	COMP FAULT	AV:60	STP#60-COMP FAULT	41060	0
61	COND FAULT	AV:61	STP#61-COND FAULT	41061	0
62	LOW SUCT PSI	AV:62	STP#62-LOW SUCT PSI	41062	1
63	HP SUCT OFST	AV:63	STP#63-HP SUCT OFST	41063	1
64	UNSAFE SUCT	AV:64	STP#64-UNSAFE SUCT	41064	1
65	LO SUCT UNLD	AV:65	STP#65-LO SUCT UNLD	41065	1
66	LO SUCT RELD	AV:66	STP#66-LO SUCT RELD	41066	1
67	LO SUCT SPHT	AV:67	STP#67-LO SUCT SPHT	41067	1
68	HI SUCT SPHT	AV:68	STP#68-HI SUCT SPHT	41068	1
69	LOW DISC PSI	AV:69	STP#69-LOW DISC PSI	41069	1
70	HI DISC PSI	AV:70	STP#70-HI DISC PSI	41070	1
71	HI DISC UNLD	AV:71	STP#71-HI DISC UNLD	41071	1
72	HI DISC RELD	AV:72	STP#72-HI DISC RELD	41072	1
73	HI DISC TEMP	AV:73	STP#73-HI DISC TEMP	41073	1
74	DiscTmpUnld	AV:74	STP#74-DiscTmpUnld	41074	1
75	DiscTmpReld	AV:75	STP#75-DiscTmpReld	41075	1
76	LO DISC SPHT	AV:76	STP#76-LO DISC SPHT	41076	1
77	DisSprhtUnld	AV:77	STP#77-DisSprhtUnld	41077	1
78	DisSprhtReld	AV:78	STP#78-DisSprhtReld	41078	1
79	LOW DIFF PSI	AV:79	STP#79-LOW DIFF PSI	41079	1
80	UnsafeDifPSI	AV:80	STP#80-UnsafeDifPSI	41080	1
81	HI PSI SW	AV:81	STP#81-HI PSI SW	41081	0
82	LO PSI SW	AV:82	STP#82-LO PSI SW	41082	0
83	PhasLossRset	AV:83	STP#83-PhasLossRset	41083	0
84	HEAT FAULT	AV:84	STP#84-HEAT FAULT	41084	0
85	HiSupplyTmp	AV:85	STP#85-HiSupplyTmp	41085	1
86	FREEZE TEMP	AV:86	STP#86-FREEZE TEMP	41086	1
87	COMPR 5 FLA	AV:87	STP#87-COMPR 5 FLA	41087	1

MCS-MICROMAG		BACnet MS/TP		MODBUS RTU	
PT#	Name	Object ID	Name	Register	#Assumed Decimal
88	COMPR 6 FLA	AV:88	STP#88-COMPR 6 FLA	41088	0
89	CFG TEST = 0	AV:89	STP#89-CFG TEST = 0	41089	1
90	HPLowAmbDsbl	AV:90	STP#90-HPLowAmbDsbl	41090	0
91	RevValveDely	AV:91	STP#91-RevValveDely	41091	1
92	HPAmbDsblDef	AV:92	STP#92-HPAmbDsblDef	41092	1
93	DEF TERM TMP	AV:93	STP#93-DEF TERM TMP	41093	0
94	MaxDefRunTim	AV:94	STP#94-MaxDefRunTim	41094	1
95	WtdDefDur %	AV:95	STP#95-WtdDefDur %	41095	0
96	BtweenDefAdj	AV:96	STP#96-BtweenDefAdj	41096	0
97	DelayBtwnDef	AV:97	STP#97-DelayBtwnDef	41097	1
98	HPCndTrgOfst	AV:98	STP#98-HPCndTrgOfst	41098	1
99	MaxTrgtReset	AV:99	STP#99-MaxTrgtReset	41099	1
100	IGN PROOF	AV:100	STP#100-IGN PROOF	41100	0
101	ModGasWarmup	AV:101	STP#101-ModGasWarmup	41101	1
102	AuxHtMin/Max	AV:102	STP#102-AuxHtMin/Max	41102	1
103	WARMUP TEMP	AV:103	STP#103-WARMUP TEMP	41103	0
104	WARMUP TIME	AV:104	STP#104-WARMUP TIME	41104	2
105	SPARE STPT	AV:105	STP#105-SPARE STPT	41105	2
106	SPARE STPT	AV:106	STP#106-SPARE STPT	41106	1
107	GasLoFireDsb	AV:107	STP#107-GasLoFireDsb	41107	0
108	SMOKE ALARM	AV:108	STP#108-SMOKE ALARM	41108	1
109	COOL RESET +	AV:109	STP#109-COOL RESET +	41109	1
110	USER RESET	AV:110	STP#110-USER RESET	41110	0
111	COOL RESET -	AV:111	STP#111-COOL RESET -	41111	0
112	HEAT RESET +	AV:112	STP#112-HEAT RESET +	41112	0
113	HEAT RESET -	AV:113	STP#113-HEAT RESET -	41113	0
114	PRECOOL TARG	AV:114	STP#114-PRECOOL TARG	41114	0
115	PRECOOL ADJ	AV:115	STP#115-PRECOOL ADJ	41115	0
116	SplyCfmTrgt	AV:116	STP#116-SplyCfmTrgt	41116	0
117	CFM STP DELY	AV:117	STP#117-CFM STP DELY	41117	0
118	MaxStaticRst	AV:118	STP#118-MaxStaticRst	41118	0
119	HOOD DEH ENB	AV:119	STP#119-HOOD DEH ENB	41119	0
120	NO FLOW	AV:120	STP#120-NO FLOW	41120	0
121	Cool UnldOff	AV:121	STP#121-Cool UnldOff	41121	0
122	Heat UnldOff	AV:122	STP#122-Heat UnldOff	41122	0
123	DEH UnldOff	AV:123	STP#123-DEH UnldOff	41123	0
124	FREEZE UNLD	AV:124	STP#124-FREEZE UNLD	41124	0
125	FREEZE RELD	AV:125	STP#125-FREEZE RELD	41125	0
126	CondStart %	AV:126	STP#126-CondStart %	41126	0
127	HI DUCT PSI	AV:127	STP#127-HI DUCT PSI	41127	0
128	WtrVlvFreeze	AV:128	STP#128-WtrVlvFreeze	41128	0
129	ERW MIN DIFF	AV:129	STP#129-ERW MIN DIFF	41129	0
130	G-RATOR STBK	AV:130	STP#130-G-RATOR STBK	41130	0
131	MODGAS STAGE %	AV:131	STP#131-MODGAS STAGE %	41131	0
132	EXV TARGET	AV:132	STP#132-EXV TARGET	41132	0

MCS-MICROMAG		BACnet MS/TP		MODBUS RTU	
PT#	Name	Object ID	Name	Register	#Assumed Decimal
133	EXV ADJUST	AV:133	STP#133-EXV ADJUST	41133	0
134	EXV LO SPRHT	AV:134	STP#134-EXV LO SPRHT	41134	0
135	EXV MOP TARG	AV:135	STP#135-EXV MOP TARG	41135	0
136	FIRE ALARM	AV:136	STP#136-FIRE ALARM	41136	0
137	CONDSATN ALM	AV:137	STP#137-CONDSATN ALM	41137	0
138	DAMPER FAULT	AV:138	STP#138-DAMPER FAULT	41138	0
139	OAD ON POS	AV:139	STP#139-OAD ON POS	41139	0
140	PREHEAT TARG	AV:140	STP#140-PREHEAT TARG	41140	0
141	PREHEAT ADJ	AV:141	STP#141-PREHEAT ADJ	41141	0
142	ERW ALARM	AV:142	STP#142-ERW ALARM	41142	0
143	SPARE STPT	AV:143	STP#143-SPARE STPT	41143	0
144	SPARE STPT	AV:144	STP#144-SPARE STPT	41144	0
145	SPARE STPT	AV:145	STP#145-SPARE STPT	41145	0
146	EXV LOAD ADJ	AV:146	STP#146-EXV LOAD ADJ	41146	0
147	DisPsiHtTape	AV:147	STP#147-DisPsiHtTape	41147	0
148	OIL LEVEL	AV:148	STP#148-OIL LEVEL	41148	0
149	SPARE STPT	AV:149	STP#149-SPARE STPT	41149	0
150	SPARE STPT	AV:150	STP#150-SPARE STPT	41150	0
151	SPARE STPT	AV:151	STP#151-SPARE STPT	41151	0
152	SPARE STPT	AV:152	STP#152-SPARE STPT	41152	0
153	SPARE STPT	AV:153	STP#153-SPARE STPT	41153	0
154	SPARE STPT	AV:154	STP#154-SPARE STPT	41154	0
155	SPARE STPT	AV:155	STP#155-SPARE STPT	41155	0
156	SPARE STPT	AV:156	STP#156-SPARE STPT	41156	0
157	SPARE STPT	AV:157	STP#157-SPARE STPT	41157	0
158	SPARE STPT	AV:158	STP#158-SPARE STPT	41158	0
159	SPARE STPT	AV:159	STP#159-SPARE STPT	41159	0
160	SPARE STPT	AV:160	STP#160-SPARE STPT	41160	0
161	SPARE STPT	AV:161	STP#161-SPARE STPT	41161	0
162	SPARE STPT	AV:162	STP#162-SPARE STPT	41162	0
163	SPARE STPT	AV:163	STP#163-SPARE STPT	41163	0
164	SPARE STPT	AV:164	STP#164-SPARE STPT	41164	0
165	SPARE STPT	AV:165	STP#165-SPARE STPT	41165	0
166	SPARE STPT	AV:166	STP#166-SPARE STPT	41166	0
167	SPARE STPT	AV:167	STP#167-SPARE STPT	41167	0
168	SPARE STPT	AV:168	STP#168-SPARE STPT	41168	0
169	SPARE STPT	AV:169	STP#169-SPARE STPT	41169	0
170	SPARE STPT	AV:170	STP#170-SPARE STPT	41170	0
171	SPARE STPT	AV:171	STP#171-SPARE STPT	41171	0
172	SPARE STPT	AV:172	STP#172-SPARE STPT	41172	0
173	SPARE STPT	AV:173	STP#173-SPARE STPT	41173	0
174	SPARE STPT	AV:174	STP#174-SPARE STPT	41174	0
175	SPARE STPT	AV:175	STP#175-SPARE STPT	41175	0
176	SPARE STPT	AV:176	STP#176-SPARE STPT	41176	0
177	SPARE STPT	AV:177	STP#177-SPARE STPT	41177	0

MCS-MICROMAG		BACnet MS/TP		MODBUS RTU	
PT#	Name	Object ID	Name	Register	#Assumed Decimal
178	SPARE STPT	AV:178	STP#178-SPARE STPT	41178	0
179	SPARE STPT	AV:179	STP#179-SPARE STPT	41179	0
180	SPARE STPT	AV:180	STP#180-SPARE STPT	41180	0
181	SPARE STPT	AV:181	STP#181-SPARE STPT	41181	0
182	SPARE STPT	AV:182	STP#182-SPARE STPT	41182	0
183	SPARE STPT	AV:183	STP#183-SPARE STPT	41183	0
184	SPARE STPT	AV:184	STP#184-SPARE STPT	41184	0
185	SPARE STPT	AV:185	STP#185-SPARE STPT	41185	0
186	SPARE STPT	AV:186	STP#186-SPARE STPT	41186	0
187	SPARE STPT	AV:187	STP#187-SPARE STPT	41187	0
188	SPARE STPT	AV:188	STP#188-SPARE STPT	41188	0
189	SPARE STPT	AV:189	STP#189-SPARE STPT	41189	0
190	SPARE STPT	AV:190	STP#190-SPARE STPT	41190	0
191	SPARE STPT	AV:191	STP#191-SPARE STPT	41191	0
192	SPARE STPT	AV:192	STP#192-SPARE STPT	41192	0
193	SPARE STPT	AV:193	STP#193-SPARE STPT	41193	0
194	SPARE STPT	AV:194	STP#194-SPARE STPT	41194	0
195	SPARE STPT	AV:195	STP#195-SPARE STPT	41195	0
196	SPARE STPT	AV:196	STP#196-SPARE STPT	41196	0
197	SPARE STPT	AV:197	STP#197-SPARE STPT	41197	0
198	SPARE STPT	AV:198	STP#198-SPARE STPT	41198	0
199	SPARE STPT	AV:199	STP#199-SPARE STPT	41199	0
200	SPARE STPT	AV:200	STP#200-SPARE STPT	41200	0

18.7. BACnet MS/TP Unit Control Information

The #Assumed Decimal column changes depending on the display type of the sensor.

MICROMAG		BACnet ID		MODBUS RTU	
PT#	Name	BACnet ID	Name	Register	#Assumed Decimal
1	Unit State	MV:0	UNIT STATE	46000	0
2	Occupation Mode	MV:1	OCCUPATION MODE	46001	0
3	Network Run Stop	MV:2	NETWORK RUN STOP	46002	0
4	Cool State	MV:15	COOL STATE	46015	0
5	ALARM 1 NAME	MV:110	ALARM 1 NAME	46110	0
6	ALARM 2 NAME	MV:111	ALARM 2 NAME	46111	0
7	ALARM 3 NAME	MV:112	ALARM 3 NAME	46112	0
8	ALARM 4 NAME	MV:113	ALARM 4 NAME	46113	0
9	ALARM 5 NAME	MV:114	ALARM 5 NAME	46114	0
10	ALARM 1 DETAILS	MV:115	ALARM 1 DETAILS	46115	0
11	ALARM 2 DETAILS	MV:116	ALARM 2 DETAILS	46116	0
12	ALARM 3 DETAILS	MV:117	ALARM 3 DETAILS	46117	0
13	ALARM 4 DETAILS	MV:118	ALARM 4 DETAILS	46118	0
14	ALARM 5 DETAILS	MV:119	ALARM 5 DETAILS	46119	0
15	EXV 1 State	MV:130	EXV 1 STATE	46130	0
16	EXV 2 State	MV:135	EXV 2 STATE	46135	0

MICROMAG		BACnet ID		MODBUS RTU	
17	EXV 3 State	MV:140	EXV 3 STATE	46140	0
18	EXV 4 State	MV:145	EXV 4 STATE	46145	0
19	EXV 5 State	MV:146	EXV 5 STATE	46146	0
20	EXV 6 State	MV:147	EXV 6 STATE	46147	0
21	Unit State Time	AV:2001	UNIT STATE TIME	42001	0
22	Unit Cool Enable	AV:2002	UNIT COOL ENABLE	42002	1
23	Cool Target Reset	AV:2003	COOL TARGET RESET	42003	1
24	Cool State Time	AV:2100	COOL STATE TIME	42100	0
25	Cool Stages Wanted	AV:2101	COOL STAGES WANTED	42101	0
26	Cool Stages Active	AV:2102	COOL STAGES ACTIVE	42102	0
27	Cool Target	AV:2103	COOL TARGET	42103	0
28	Cool Control SI	AV:2104	COOL CONTROL SI	42104	1
29	Cool Wanted Capacity	AV:2105	COOL WANTED CAPACITY	42105	1
30	Cool Adjust Delay	AV:2106	COOL ADJUST DELAY	42106	0
31	Cool ROC	AV:2107	COOL ROC	42107	1

18.8. BACnet Compressor States

MICROMAG		BACnet ID		MODBUS RTU	
PT#	Name	BACnet ID	Name	Register	#Assumed Decimal
1	COMP #1 State	MV:20	COMP #1 STATE	46020	0
2	COMP #2 State	MV:25	COMP #2 STATE	46025	0
3	COMP #3 State	MV:30	COMP #3 STATE	46030	0
4	COMP #4 State	MV:35	COMP #4 STATE	46035	0
5	COMP #5 State	MV:160	COMP #5 STATE	46160	0
6	COMP #6 State	MV:165	COMP #6 STATE	46165	0
7	COND #1 State	MV:40	COND #1 STATE	46040	0
8	COND #3 State	MV:45	COND #3 STATE	46045	0
9	COND #4 State	MV:50	COND #4 STATE	46050	0
10	COND #5 State	MV:170	COND #5 STATE	46170	0
11	COND #6 State	MV:171	COND #6 STATE	46171	0
12	Cond 1 State Time	AV:2150	COND 1 STATE TIME	42150	0
13	Cond 1 Stages Wanted	AV:2151	COND 1 STAGES WANTED	42151	0
14	Cond 1 Stages Active	AV:2152	COND 1 STAGES ACTIVE	42152	0
15	Cond 1 Target	AV:2153	COND 1 TARGET	42153	0
16	Cond 1 Control SI	AV:2154	COND 1 CONTROL SI	42154	1
17	Cond 1 Wanted Capacity	AV:2155	COND 1 WANTED CAPACITY	42155	1
18	Cond 1 Adjust Delay	AV:2156	COND 1 ADJUST DELAY	42156	0
19	Cond 1 ROC	AV:2157	COND 1 ROC	42157	1
20	Cond 3 State Time	AV:2250	COND 3 STATE TIME	42250	0
21	Cond 3 Stages Wanted	AV:2251	COND 3 STAGES WANTED	42251	0
22	Cond 3 Stages Active	AV:2252	COND 3 STAGES ACTIVE	42252	0
23	Cond 3 Target	AV:2253	COND 3 TARGET	42253	0
24	Cond 3 Control SI	AV:2254	COND 3 CONTROL SI	42254	1
25	Cond 3 Wanted Capacity	AV:2255	COND 3 WANTED CAPACITY	42255	1
26	Cond 3 Adjust Delay	AV:2256	COND 3 ADJUST DELAY	42256	0
27	Cond 3 ROC	AV:2257	COND 3 ROC	42257	1

MICROMAG		BACnet ID		MODBUS RTU	
28	Cond 4 State Time	AV:2300	COND 4 STATE TIME	42300	0
29	Cond 4 Stages Wanted	AV:2301	COND 4 STAGES WANTED	42301	0
30	Cond 4 Stages Active	AV:2302	COND 4 STAGES ACTIVE	42302	0
31	Cond 4 Target	AV:2303	COND 4 TARGET	42303	0
32	Cond 4 Control SI	AV:2304	COND 4 CONTROL SI	42304	1
33	Cond 4 Wanted Capacity	AV:2305	COND 4 WANTED CAPACITY	42305	1
34	Cond 4 Adjust Delay	AV:2306	COND 4 ADJUST DELAY	42306	0
35	Cond 4 ROC	AV:2307	COND 4 ROC	42307	1
36	Cond 5 State Time	AV:2320	COND 5 STATE TIME	42320	0
37	Cond 5 Stages Wanted	AV:2321	COND 5 STAGES WANTED	42321	0
38	Cond 5 Stages Active	AV:2322	COND 5 STAGES ACTIVE	42322	0
39	Cond 5 Target	AV:2323	COND 5 TARGET	42323	0
40	Cond 5 Control SI	AV:2324	COND 5 CONTROL SI	42324	1
41	Cond 5 Wanted Capacity	AV:2325	COND 5 WANTED CAPACITY	42325	1
42	Cond 5 Adjust Delay	AV:2326	COND 5 ADJUST DELAY	42326	0
43	Cond 5 ROC	AV:2327	COND 5 ROC	42327	1
44	Cond 6 State Time	AV:2330	COND 6 STATE TIME	42330	0
45	Cond 6 Stages Wanted	AV:2331	COND 6 STAGES WANTED	42331	0
46	Cond 6 Stages Active	AV:2332	COND 6 STAGES ACTIVE	42332	0
47	Cond 6 Target	AV:2333	COND 6 TARGET	42333	0
48	Cond 6 Control SI	AV:2334	COND 6 CONTROL SI	42334	1
49	Cond 6 Wanted Capacity	AV:2335	COND 6 WANTED CAPACITY	42335	1
50	Cond 6 Adjust Delay	AV:2336	COND 6 ADJUST DELAY	42336	0
51	Cond 6 ROC	AV:2337	COND 6 ROC	42337	1
52	Comp 1 State Time	AV:2450	COMP 1 STATE TIME	42450	0
53	Comp 1 Sat Suction	AV:2452	COMP 1 SAT SUCTION	42452	1
54	Comp 1 Sat Dis Temp	AV:2454	COMP 1 SAT DIS TEMP	42454	1
55	Comp 1 Dis SH	AV:2455	COMP 1 DIS SH	42455	1
56	Comp 1 Oil Diff	AV:2456	COMP 1 OIL DIFF	42456	1
57	Comp 1 Lead Comp	AV:2457	COMP 1 LEAD COMP	42457	0
58	Comp 2 State Time	AV:2500	COMP 2 STATE TIME	42500	0
59	Comp 2 Sat Suction	AV:2502	COMP 2 SAT SUCTION	42502	1
60	Comp 2 Sat Dis Temp	AV:2504	COMP 2 SAT DIS TEMP	42504	1
61	Comp 2 Oil Diff	AV:2506	COMP 2 OIL DIFF	42506	1
62	Comp 2 Lead Comp	AV:2507	COMP 2 LEAD COMP	42507	0
63	Comp 3 State Time	AV:2550	COMP 3 STATE TIME	42550	0
64	Comp 3 Lead Comp	AV:2557	COMP 3 LEAD COMP	42557	0
65	Comp 4 State Time	AV:2600	COMP 4 STATE TIME	42600	0
66	Comp 4 Lead Comp	AV:2607	COMP 4 LEAD COMP	42607	0
67	Comp 5 State Time	AV:2610	COMP 5 STATE TIME	42610	0
68	Comp 5 Lead Comp	AV:2617	COMP 5 LEAD COMP	42617	0
69	Comp 6 State Time	AV:2620	COMP 6 STATE TIME	42620	0
70	Comp 6 Lead Comp	AV:2627	COMP 6 LEAD COMP	42627	0

18.9. BMS Writable Network Points Information

POINT MAPPING INFO BUILT IN MCS-MICROMAG

MICROMAG		BACnet ID		MODBUS RTU	
PT#	Name	BACnet ID	Name	Register	#Assumed Decimal
1	Net_R/S	AV:2008	Net_R/S	42008	0
2	Net_Occ_Mode	AV:2009	Net_Occ_Mode	42009	0

18.10. BMS Points Writable Setpoint Points Grid Information

POINT MAPPING INFO BUILT IN MCS-MICROMAG

MICROMAG		BACnet ID		MODBUS RTU	
PT#	Name	Object ID	Name	Register	#Assumed Decimal
1	COOL ENABLE	AV:1	COOL ENABLE	41001	1
2	HEAT ENABLE	AV:2	HEAT ENABLE	41002	1
3	DEH ENABLE	AV:3	DEH ENABLE	41003	1
4	DehCmpMinOvr	AV:4	DehCmpMinOvr	41004	1
5	CoolNiteStbk	AV:5	CoolNiteStbk	41005	1
6	HeatNiteStbk	AV:6	HeatNiteStbk	41006	1
7	Deh NiteStbk	AV:7	Deh NiteStbk	41007	1
8	COOL TARGET	AV:8	COOL TARGET	41008	1
10	HEAT TARGET	AV:10	HEAT TARGET	41010	1
12	REHT TARGET	AV:12	REHT TARGET	41012	1
14	SplyStatcTrg	AV:14	SplyStatcTrg	41014	2
17	CND TRGT PSI	AV:17	CND TRGT PSI	41017	1
19	EconAmbEnabl	AV:19	EconAmbEnabl	41019	1
21	HiCO2MinDmpr	AV:21	HiCO2MinDmpr	41021	1
22	MIN DAMPER %	AV:22	MIN DAMPER %	41022	1
26	BldgStatcTrg	AV:26	BldgStatcTrg	41026	2
32	HI CO2 LEVEL	AV:32	HI CO2 LEVEL	41032	0
114	PRECOOL TARG	AV:114	PRECOOL TARG	41114	0

18.11. BMS SI Information

POINT MAPPING INFO THROUGH OPTIONAL MCS-BMS-GATEWAY

MicroMag		BACnet IP		LONTALK	
PT#	ID	NAME	ID	NAME	
Sensor M-1	AI:1	Refer to Config	AI:1	Refer to Config	
Sensor M-2	AI:2	Refer to Config	AI:2	Refer to Config	
Sensor M-3	AI:3	Refer to Config	AI:3	Refer to Config	
Sensor M-4	AI:4	Refer to Config	AI:4	Refer to Config	
Sensor M-5	AI:5	Refer to Config	AI:5	Refer to Config	
Sensor M-6	AI:6	Refer to Config	AI:6	Refer to Config	
Sensor M-7	AI:7	Refer to Config	AI:7	Refer to Config	
Sensor M-8	AI:8	Refer to Config	AI:8	Refer to Config	
Sensor M-9	AI:9	Refer to Config	AI:9	Refer to Config	
Sensor M-10	AI:10	Refer to Config	AI:10	Refer to Config	
Sensor 1-1	AI:11	Refer to Config	AI:11	Refer to Config	
Sensor 1-2	AI:12	Refer to Config	AI:12	Refer to Config	

MicroMag	BACnet IP		LONTALK	
Sensor 1-3	AI:13	Refer to Config	AI:13	Refer to Config
Sensor 1-4	AI:14	Refer to Config	AI:14	Refer to Config
Sensor 1-5	AI:15	Refer to Config	AI:15	Refer to Config
Sensor 1-6	AI:16	Refer to Config	AI:16	Refer to Config
Sensor 1-7	AI:17	Refer to Config	AI:17	Refer to Config
Sensor 1-8	AI:18	Refer to Config	AI:18	Refer to Config
Sensor 1-9	AI:19	Refer to Config	AI:19	Refer to Config
Sensor 1-10	AI:20	Refer to Config	AI:20	Refer to Config
Sensor 1-11	AI:21	Refer to Config	AI:21	Refer to Config
Sensor 1-12	AI:22	Refer to Config	AI:22	Refer to Config
Sensor 1-13	AI:23	Refer to Config	AI:23	Refer to Config
Sensor 1-14	AI:24	Refer to Config	AI:24	Refer to Config
Sensor 1-15	AI:25	Refer to Config	AI:25	Refer to Config
Sensor 1-16	AI:26	Refer to Config	AI:26	Refer to Config
Sensor 2-1	AI:27	Refer to Config	AI:27	Refer to Config
Sensor 2-2	AI:28	Refer to Config	AI:28	Refer to Config
Sensor 2-3	AI:29	Refer to Config	AI:29	Refer to Config
Sensor 2-4	AI:30	Refer to Config	AI:30	Refer to Config
Sensor 2-5	AI:31	Refer to Config	AI:31	Refer to Config
Sensor 2-6	AI:32	Refer to Config	AI:32	Refer to Config
Sensor 2-7	AI:33	Refer to Config	AI:33	Refer to Config
Sensor 2-8	AI:34	Refer to Config	AI:34	Refer to Config
Sensor 2-9	AI:35	Refer to Config	AI:35	Refer to Config
Sensor 2-10	AI:36	Refer to Config	AI:36	Refer to Config
Sensor 2-11	AI:37	Refer to Config	AI:37	Refer to Config
Sensor 2-12	AI:38	Refer to Config	AI:38	Refer to Config
Sensor 2-13	AI:39	Refer to Config	AI:39	Refer to Config
Sensor 2-14	AI:40	Refer to Config	AI:40	Refer to Config
Sensor 2-15	AI:41	Refer to Config	AI:41	Refer to Config
Sensor 2-16	AI:42	Refer to Config	AI:42	Refer to Config

18.12. BMS RO Information - MCS-BMS-GATEWAY

POINT MAPPING INFO THROUGH OPTIONAL MCS-BMS-GATEWAY

MicroMag	BACnet IP		LONTALK	
PT#	ID	NAME	ID	NAME
Relay M-1	DO:1	M_1_Refer to Config	DO:1	M_1_Refer to Configro
Relay M-2	DO:2	M_2_Refer to Config	DO:2	M_2_Refer to Configro
Relay M-3	DO:3	M_3_Refer to Config	DO:3	M_3_Refer to Configro

Relay M-4	DO:4	M_4_Refer to Config	DO:4	M_4_Refer to Configro
Relay M-5	DO:5	M_5_Refer to Config	DO:5	M_5_Refer to Configro
Relay M-6	DO:6	M_6_Refer to Config	DO:6	M_6_Refer to Configro
Relay 1-1	DO:7	1-1 Refer to Config	DO:7	1-1 Refer to Configro
Relay 1-2	DO:8	1-2 Refer to Config	DO:8	1-2 Refer to Configro
Relay 1-3	DO:9	1-3 Refer to Config	DO:9	1-3 Refer to Configro
Relay 1-4	DO:10	1-4 Refer to Config	DO:10	1-4 Refer to Configro
Relay 1-5	DO:11	1-5 Refer to Config	DO:11	1-5 Refer to Configro
Relay 1-6	DO:12	1-6 Refer to Config	DO:12	1-6 Refer to Configro
Relay 1-7	DO:13	1-7 Refer to Config	DO:13	1-7 Refer to Configro
Relay 1-8	DO:14	1-8 Refer to Config	DO:14	1-8 Refer to Configro
Relay 1-9	DO:15	1-9 Refer to Config	DO:15	1-9 Refer to Configro
Relay 1-10	DO:16	1-10 Refer to Config	DO:16	1-10 Refer to Configro
Relay 2-1	DO:17	2-1 Refer to Config	DO:17	2-1 Refer to Configro
Relay 2-2	DO:18	2-2 Refer to Config	DO:18	2-2 Refer to Configro
Relay 2-3	DO:19	2-3 Refer to Config	DO:19	2-3 Refer to Configro
Relay 2-4	DO:20	2-4 Refer to Config	DO:20	2-4 Refer to Configro

18.13. BMS AO Information - MCS-BMS-GATEWAY

POINT MAPPING INFO THROUGH OPTIONAL MCS-BMS-GATEWAY

MicroMag		BACnet IP		LONTALK	
PT#	ID	NAME	ID	NAME	
M-T	AO:1	M_T_TRIACSPARE	AO:1	M_T_TRIACSPARao	
Analog M-1	AO:2	M_1_Refer to Config	AO:2	M_1_Refer to Configao	
Analog M-2	AO:3	M_2_Refer to Config	AO:3	M_2_Refer to Configao	
Analog M-3	AO:4	M_3_Refer to Config	AO:4	M_3_Refer to Configao	
Analog M-4	AO:5	M_4_Refer to Config	AO:5	M_4_Refer to Configao	
Analog 1-1	AO:6	1-1 Refer to Config	AO:6	1-1 Refer to Configao	
Analog 1-2	AO:7	1-2 Refer to Config	AO:7	1-2 Refer to Configao	
Analog 1-3	AO:8	1-3 Refer to Config	AO:8	1-3 Refer to Configao	
Analog 1-4	AO:9	1-4 Refer to Config	AO:9	1-4 Refer to Configao	
Analog 2-1	AO:10	2-2 Refer to Config	AO:10	2-2 Refer to Configao	
Analog 2-2	AO:11	2-3 Refer to Config	AO:11	2-3 Refer to Configao	
Analog 2-3	AO:12	2-4 Refer to Config	AO:12	2-4 Refer to Configao	
Analog 2-4	AO:13	2-5 Refer to Config	AO:13	2-5Refer to Configao	

18.14. BMS Unit Control - MCS-BMS-GATEWAY

POINT MAPPING INFO THROUGH OPTIONAL MCS-BMS-GATEWAY

BACnet IP		LONTALK	
ID	NAME	ID	NAME
MV:0	Unit_State	MV:0	UnitState
MV:1	Occupation Mode	MV:1	Occupation Mode

BACnet IP		LONTALK	
ID	NAME	ID	NAME
MV:2	Network_Run_Stop	MV:2	Network_Run_Stop
MV:15	Cool_State	MV:15	Cool_State
MV:110	ALARM_1_DETAILS	MV:110	ALARM_1_DETAILS
MV:111	ALARM_2_DETAILS	MV:111	ALARM_2_DETAILS
MV:112	ALARM_3_DETAILS	MV:112	ALARM_3_DETAILS
MV:113	ALARM_4_DETAILS	MV:113	ALARM_4_DETAILS
MV:114	ALARM_5_DETAILS	MV:114	ALARM_5_DETAILS
MV:115	ALARM_1_DETAILS	MV:115	ALARM_1_DETAILS
MV:116	ALARM_2_DETAILS	MV:116	ALARM_2_DETAILS
MV:117	ALARM_3_DETAILS	MV:117	ALARM_3_DETAILS
MV:118	ALARM_4_DETAILS	MV:118	ALARM_4_DETAILS
MV:119	ALARM_5_DETAILS	MV:119	ALARM_5_DETAILS
MV:130	EXV_1_State	MV:130	EXV1State
MV:135	EXV_2_State	MV:135	EXV2State
MV:140	EXV_3_State	MV:140	EXV3State
MV:145	EXV_4_State	MV:145	EXV4State
MV:146	EXV_5_State	MV:146	EXV5State
MV:147	EXV_6_State	MV:147	EXV6State
AV:2001	Unit_State_Time	AV:2001	UnitStateTime
AV:2002	Unit_Cool_Enable	AV:2002	UnitCoolEnable
AV:2003	Cool_Target_Reset	AV:2003	CoolTargetReset
AV:2100	Cool_State_Time	AV:2100	CoolStateTime
AV:2101	Cool_Stages_Wanted	AV:2101	CoolStagesWanted
AV:2102	Cool_Stages_Active	AV:2102	CoolStagesActive
AV:2103	Cool_Target	AV:2103	CoolTarget
AV:2104	Cool_Control_SI	AV:2104	CoolControlSI
AV:2105	Cool_Wanted_Capacity	AV:2105	CoolWantedCapacity
AV:2106	Cool_Adjust_Delay	AV:2106	CoolAdjustDelay
AV:2107	Cool_ROC	AV:2107	CoolROC

18.15. BMS Compressor/Condenser Points - MCS-BMS-GATEWAY

POINT MAPPING INFO THROUGH OPTIONAL MCS-BMS-GATEWAY

BACnet IP		LONTALK	
ID	NAME	ID	NAME
MV:20	CP1_State	MV:20	CP1_State
MV:25	CP2_State	MV:25	CP2_State
MV:30	CP3_State	MV:30	CP3_State
MV:35	CP4_State	MV:35	CP4_State
MV:160	CP5_State	MV:160	CP5_State
MV:165	CP6_State	MV:165	CP6_State
MV:40	CD1_State	MV:40	CD1_State
MV:45	CD3_State	MV:45	CD3_State
MV:50	CD4_State	MV:50	CD4_State
MV:170	CD5_State	MV:170	CD5_State

BACnet IP		LONTALK	
ID	NAME	ID	NAME
MV:171	CD6_State	MV:171	CD6_State
AV:2150	Cond1_State_Time	AV:2150	Cond1StateTime
AV:2151	Cond1_Stages_Wanted	AV:2151	Cond1StagesWanted
AV:2152	Cond1_Stages_Active	AV:2152	Cond1StagesActive
AV:2153	Cond1_Target	AV:2153	Cond1Target
AV:2154	Cond1_Control_SI	AV:2154	Cond1ControlSI
AV:2155	Cond1_Wanted_Capacity	AV:2155	Cond1WantedCapacity
AV:2156	Cond1_Adjust_Delay	AV:2156	Cond1AdjustDelay
AV:2157	Cond1_ROC	AV:2157	Cond1ROC
AV:2250	Cond3_State_Time	AV:2250	Cond3StateTime
AV:2251	Cond3_Stages_Wanted	AV:2251	Cond3StagesWanted
AV:2252	Cond3_Stages_Active	AV:2252	Cond3StagesActive
AV:2253	Cond3_Target	AV:2253	Cond3Target
AV:2254	Cond3_Control_SI	AV:2254	Cond3ControlSI
AV:2255	Cond3_Wanted_Capacity	AV:2255	Cond3WantedCapacity
AV:2256	Cond3_Adjust_Delay	AV:2256	Cond3AdjustDelay
AV:2257	Cond3_ROC	AV:2257	Cond3ROC
AV:2300	Cond4_State_Time	AV:2300	Cond4StateTime
AV:2301	Cond4_Stages_Wanted	AV:2301	Cond4StagesWanted
AV:2302	Cond4_Stages_Active	AV:2302	Cond4StagesActive
AV:2303	Cond4_Target	AV:2303	Cond4Target
AV:2304	Cond4_Control_SI	AV:2304	Cond4ControlSI
AV:2305	Cond4_Wanted_Capacity	AV:2305	Cond4WantedCapacity
AV:2306	Cond4_Adjust_Delay	AV:2306	Cond4AdjustDelay
AV:2307	Cond4_ROC	AV:2307	Cond4ROC
AV:2320	Cond5_State_Time	AV:2320	Cond5StateTime
AV:2321	Cond5_Stages_Wanted	AV:2321	Cond5StagesWanted
AV:2322	Cond5_Stages_Active	AV:2322	Cond5StagesActive
AV:2323	Cond5_Target	AV:2323	Cond5Target
AV:2324	Cond5_Control_SI	AV:2324	Cond5ControlSI
AV:2325	Cond5_Wanted_Capacity	AV:2325	Cond5WantedCapacity
AV:2326	Cond5_Adjust_Delay	AV:2326	Cond5AdjustDelay
AV:2327	Cond5_ROC	AV:2327	Cond5ROC
AV:2330	Cond6_State_Time	AV:2330	Cond6StateTime
AV:2331	Cond6_Stages_Wanted	AV:2331	Cond6StagesWanted
AV:2332	Cond6_Stages_Active	AV:2332	Cond6StagesActive
AV:2333	Cond6_Target	AV:2333	Cond6Target
AV:2334	Cond6_Control_SI	AV:2334	Cond6ControlSI
AV:2335	Cond6_Wanted_Capacity	AV:2335	Cond6WantedCapacity
AV:2336	Cond6_Adjust_Delay	AV:2336	Cond6AdjustDelay
AV:2337	Cond6_ROC	AV:2337	Cond6ROC
AV:2450	Comp1_State_Time	AV:2450	Comp1StateTime
AV:2452	Comp1_Sat_Suction	AV:2452	Comp1SatSuction
AV:2454	Comp1_Sat_Dis_Temp	AV:2454	Comp1SatDisTemp
AV:2455	Comp1_Dis_SH	AV:2455	Comp1DisSH

BACnet IP		LONTALK	
ID	NAME	ID	NAME
AV:2456	Comp1_Oil_Diff	AV:2456	Comp1OilDiff
AV:2457	Comp1_Lead_Comp	AV:2457	Comp1LeadComp
AV:2500	Comp2_State_Time	AV:2500	Comp2StateTime
AV:2502	Comp2_Sat_Suction	AV:2502	Comp2SatSuction
AV:2504	Comp2_Sat_Dis_Temp	AV:2504	Comp2SatDisTemp
AV:2506	Comp2_Oil_Diff	AV:2506	Comp2OilDiff
AV:2507	Comp2_Lead_Comp	AV:2507	Comp2LeadComp
AV:2550	Comp3_State_Time	AV:2550	Comp3StateTime
AV:2557	Comp3_Lead_Comp	AV:2557	Comp3LeadComp
AV:2600	Comp4_State_Time	AV:2600	Comp4StateTime
AV:2607	Comp4_Lead_Comp	AV:2607	Comp4LeadComp
AV:2610	Comp5_State_Time	AV:2610	Comp5StateTime
AV:2617	Comp5_Lead_Comp	AV:2617	Comp5LeadComp
AV:2620	Comp6_State_Time	AV:2620	Comp6StateTime
AV:2627	Comp6_Lead_Comp	AV:2627	Comp6LeadComp

18.16. Writeable Network Points- MCS-BMS-GATEWAY

POINT MAPPING INFO THROUGH OPTIONAL MCS-BMS-GATEWAY

BACnet IP		LONTALK	
ID	NAME	ID	NAME
AV:2008	NETRN_ST	AV:2008	iNETRN_ST
AV:2009	NET_OCC_MODE	AV:2009	iNETOCCMODE

Chapter - 19. BMS STATE LIST

19.1. CHILLER_ALGO_STATE_LIST

MCS/MODBUS RTU	BACnet MS/TP	
Present Value	Present Value	State-Text
0	1	PowerUpDelay
1	2	MCS IO FAILED
2	3	MACH LOCKOUT
3	4	OFF SMOKE AL
4	5	OFF SCHEDULE
5	6	OFF SATISFIED
6	7	OFF NET STOP
7	8	OFF RUN/STOP
8	9	DIRECT SUPERV
9	10	EVAP FAN ONLY
10	11	COOLING
11	12	HEATING
12	13	DEHUMID
13	14	HEAT: HP ONLY
14	15	HEAT:HP + AUX
15	16	HEAT:AUX ONLY
16	17	HEAT:AUX+EMRG
17	18	HEAT:ALL
18	19	HEAT:EMERG
19	20	HEAT:PRIMARY
20	21	MORN WARM UP
21	22	COOL:HI HUMID
22	23	MORN COOLDOWN

19.2. BACNET_MSV_OCCUPATION_MODE MSV:1

MCS/MODBUS RTU	BACnet MS/TP	
Present Value	Present Value	State-Text
0	1	OCCUPIED
1	2	UNOCCUPIED
2	3	OVERRIDE
3	4	SCHEDULE
4	5	GENERATOR

19.3. BACNET_MSV_NETWORK_RUN_STOP MSV:2

MCS/MODBUS RTU	BACnet MS/TP	
Present Value	Present Value	State-Text
0	1	STOP
1	2	RUN

19.4. BACNET_MSV_EVAPORATOR_STATE MSV:10

CHILLER cfg

MCS/MODBUS RTU	BACnet MS/TP	
Present Value	Present Value	State-Text
0	1	PUMP INIT
1	2	UNLDING AZ
2	3	LOADING AZ
3	4	HOLDING AZ
4	5	UNLDING BZ
5	6	LOADING BZ
6	7	HOLDING BZ
7	8	UNLDING IZ
8	9	LOADING IZ
9	10	HOLDING IZ
10	11	UNLD ROC
11	12	LOAD ROC
12	13	HOLD ROC
13	14	HOLD STAGE
14	15	HOLD STAGE
15	16	CAV CNTRL
16	17	PUMP ON
17	18	DISABLED
18	19	LOCKED OUT
19	20	POST DELAY
20	21	PRE DELAY
21	22	PUMP OFF
22	23	SUPERVISOR

19.5. BACNET_MSV_COOLING / PRECOOLING STATES

BACNET_MSV_COOLING_STATE MSV:15

BACNET_MSV_PRECOOLING_STATE MSV:90

MCS/MODBUS RTU	BACnet MS/TP	
Present Value	Present Value	State-Text
0	1	COOL ON
1	2	UNLDING AZ
2	3	LOADING AZ
3	4	HOLDING AZ
4	5	UNLDING BZ
5	6	LOADING BZ
6	7	HOLDING BZ
7	8	UNLDING IZ
8	9	LOADING IZ
9	10	HOLDING IZ
10	11	UNLD ROC
11	12	LOAD ROC
12	13	HOLD ROC
13	14	HOLD STAGE
14	15	HOLD STAGE
15	16	OFF&READY
16	17	DISABLED
17	18	NO FLOW
18	19	LOCKED OUT
19	20	N/A
20	21	SUPERVISOR
21	22	HOLD PCOOL
22	23	UNLD HIAMP
23	24	UNLD HITMP
24	25	HOLD HITMP

19.6. COMPRESSOR STATES

BACNET_MSV_COMPRESSOR_1_STATE MSV:20

BACNET_MSV_COMPRESSOR_2_STATE MSV:25

BACNET_MSV_COMPRESSOR_3_STATE MSV:30

BACNET_MSV_COMPRESSOR_4_STATE MSV:35

BACNET_MSV_COMPRESSOR_5_STATE MSV:160

BACNET_MSV_COMPRESSOR_6_STATE MSV:165

MCS/MODBUS RTU	BACnet MS/TP	
Present Value	Present Value	State-Text
0	1	LOST IO
1	2	SAFETY TRP
2	3	LOCKOUT
3	4	DISABLED
4	5	OFF:LowAmb
5	6	OFF: DEHUM
6	7	PUMPDOWN
7	8	ANTI CYCLE
8	9	OFF&READY
9	10	REVERSING
10	11	START-UP
11	12	RUNNING
12	13	DEFROSTING
13	14	SucPsiHOLD
14	15	SucPsiUNLD
15	16	DisPsiUNLD
16	17	DisPsiHOLD
17	18	UNLD LOTMP
18	19	HOLD LOTMP
19	20	HOLD HIAMP
20	21	DIS TMPHLD
21	22	HOLD HIWTR
22	23	UNLD HIAMP
23	24	UNLD HITMP
24	25	HOLD HITMP
25	26	DIS TmUNLD
26	27	DisSH UNLD
27	28	DisSH HOLD
28	29	FreezeUNLD
29	30	FreezeHOLD
30	31	CMP @ 100%

19.7. CONDENSER STATES

BACNET_MSV_CONDENSER_1_STATE MSV:40

BACNET_MSV_CONDENSER_2_STATE MSV:45

BACNET_MSV_CONDENSER_3_STATE MSV:50

BACNET_MSV_CONDENSER_4_STATE MSV:55

BACNET_MSV_CONDENSER_5_STATE MSV:170

BACNET_MSV_CONDENSER_6_STATE MSV:171

MCS/MODBUS RTU	BACnet MS/TP	
Present Value	Present Value	State-Text
0	1	COND INIT
1	2	UNLDING AZ
2	3	LOADING AZ
3	4	HOLDING AZ
4	5	UNLDING BZ
5	6	LOADING BZ
6	7	HOLDING BZ
7	8	UNLDING IZ
8	9	LOADING IZ
9	10	HOLDING IZ
10	11	UNLD ROC
11	12	LOAD ROC
12	13	HOLD ROC
13	14	HOLD STAGE
14	15	HOLD STAGE
15	16	DISABLED
16	17	NO FLOW
17	18	LOCKED OUT
18	19	COND OFF
19	20	N/A

19.8. HEATING / IGNITION STATES - RTU ONLY

BACNET_MSV_HEATING_STATE MSV:60

BACNET_MSV_IGNITION_1_STATE MSV:70

BACNET_MSV_IGNITION_2_STATE MSV:75

BACNET_MSV_IGNITION_3_STATE MSV:80

BACNET_MSV_IGNITION_4_STATE MSV:85

BACNET_MSV_IGNITION_5_STATE MSV:86

BACNET_MSV_IGNITION_6_STATE MSV:87

MCS/MODBUS RTU	BACnet MS/TP	State-Text
Present Value	Present Value	
0	1	HEAT INIT
1	2	UNLDING AZ
2	3	LOADING AZ
3	4	HOLDING AZ
4	5	UNLDING BZ
5	6	LOADING BZ
6	7	HOLDING BZ
7	8	UNLDING IZ
8	9	LOADING IZ
19	10	HOLDING IZ
10	11	UNLD ROC
11	12	LOAD ROC
12	13	HOLD ROC
13	14	HOLD STAGE
14	15	HOLD STAGE
15	16	IGNITION
16	17	WARMING UP
17	18	OPERATING
18	19	HOLD IGNTN
19	20	OFF&READY
20	21	DISABLED
21	22	NO FLOW
22	23	LOCKED OUT
23	24	N/A
24	25	SUPERVISOR
25	26	SAFETY TRP
26	27	HI AMBIENT

19.9. REHEAT STATE - RTU ONLY

BACNET_MSV_REHEAT_STATE MSV:65

MCS/MODBUS RTU	BACnet MS/TP	
Present Value	Present Value	State-Text
0	1	REHEAT INI
1	2	UNLDING AZ
2	3	LOADING AZ
3	4	HOLDING AZ
4	5	UNLDING BZ
5	6	LOADING BZ
6	7	HOLDING BZ
7	8	UNLDING IZ
8	9	LOADING IZ
9	10	HOLDING IZ
10	11	UNLD ROC
11	12	LOAD ROC
12	13	HOLD ROC
13	14	HOLD STAGE
14	15	HOLD STAGE
15	16	OFF&READY
16	17	DISABLED
17	18	NO FLOW
18	19	LOCKED OUT
19	20	N/A

19.10. ECONOMIZER STATE

BACNET_MSV_ECONOMIZER_STATE MSV:95

MCS/MODBUS RTU	BACnet MS/TP	
Present Value	Present Value	State-Text
0	1	OFF AND CLOSED
1	2	AT MIN OPEN %
2	3	AT HI CO2 OPEN %
3	4	ECON ON - NORMAL
4	5	ECON ON - HI CO2
5	6	OUTDR DMPR OPEN
6	7	OUTDR DMPR OFF
7	8	ECON ON--HOOD ON
8	9	EXHAUST HOOD ON
9	10	BLDG PSI CONTROL

19.11. EXHAUST STATE

BACNET_MSV_EXHAUST_STATE MSV:100

MCS/MODBUS RTU	BACnet MS/TP	
Present Value	Present Value	State-Text
0	1	CTRL INIT
1	2	UNLDING AZ
2	3	LOADING AZ
3	4	HOLDING AZ
4	5	UNLDING BZ
5	6	LOADING BZ
6	7	HOLDING BZ
7	8	UNLDING IZ
8	9	LOADING IZ
9	10	HOLDING IZ
10	11	UNLD ROC
11	12	LOAD ROC
12	13	HOLD ROC
13	14	HOLD STAGE
14	15	HOLD STAGE
15	16	OFF&READY
16	17	DISABLED
17	18	NO FLOW
18	19	LOCKED OUT
19	20	N/A
20	21	HOOD ON

19.12. EXV STATES

BACNET_MSV_EXV_1_STATE MSV:130

BACNET_MSV_EXV_2_STATE MSV:135

BACNET_MSV_EXV_3_STATE MSV:140

BACNET_MSV_EXV_4_STATE MSV:145

BACNET_MSV_EXV_5_STATE MSV:150

BACNET_MSV_EXV_6_STATE MSV:155

MCS/MODBUS RTU	BACnet MS/TP	
Present Value	Present Value	State-Text
0	1	EXV CLOSED
1	2	PrePmpDown
2	3	EXV HLDING
3	4	EXV START
4	5	EXV OPNING
5	6	EXV CLSING
6	7	Low SuprHt
7	8	OPENING 4X
8	9	OPENING 2X
9	10	LoSuctOpen
10	11	CLOSING 2X
11	12	CLOSING 4X
12	13	MOP CLSING
13	14	MOP HLDING

Chapter - 20. BMS COMMUNICATION PROTOCOLS

BMS WILL ONLY SHOW 5 OF THE LATEST ALARMS AND THE ALARMS DETAIL WHICH WAS CREATED BY THE MICROMAG CONTROLLER.

BMS Communication Protocols					
<input type="radio"/> SI Points <input type="radio"/> RO Points <input type="radio"/> AO Points <input type="radio"/> Setpoint Values <input checked="" type="radio"/> Unit Control Info <input type="radio"/> Compressor Points <input type="radio"/> Writable Points					
Unit Control Info					
POINT MAPPING INFO BUILT IN MCS-MICROMAG					
MCS-MICROMAG		BACNET MSTP		MODBUS RTU	
1	ALARM 1 NAME	MV:110	ALARM 1 NAME	46110	0
2	ALARM 2 NAME	MV:111	ALARM 2 NAME	46111	0
3	ALARM 3 NAME	MV:112	ALARM 3 NAME	46112	0
4	ALARM 4 NAME	MV:113	ALARM 4 NAME	46113	0
5	ALARM 5 NAME	MV:114	ALARM 5 NAME	46114	0
6	ALARM 1 DETAILS	MV:115	ALARM 1 DETAILS	46115	0
7	ALARM 2 DETAILS	MV:116	ALARM 2 DETAILS	46116	0
8	ALARM 3 DETAILS	MV:117	ALARM 3 DETAILS	46117	0
9	ALARM 4 DETAILS	MV:118	ALARM 4 DETAILS	46118	0
10	ALARM 5 DETAILS	MV:119	ALARM 5 DETAILS	46119	0

19.13. Reading Alarm Points For MicroMag

For the Building Management System(BMS) to read MicroMag alarms, please reference the charts on the following pages.

First look for '**ALARM NAME**' and compare the value received from the BMS to the chart named Alarm Name. This will tell you what the alarm is. Then look at the Alarm Detail and compare the value to the chart titled Alarm detail.

This will tell you the number of the referenced component, Setpoint, Sensor Input, Relay Output, or Analog Output that is associated with that alarm.

If an alarm occurs that is NOT associated with a board point, Setpoint, Sensor Input, Relay Output, or Analog Output, **THEN THE ALARM DETAIL SHOULD BE A '1' for N/A.**

Examples:

There is a lockout reset performed:

Alarm Name = LCKOUT RESET which is a value of 18 Alarm Detail = N/A which is a value of 1
 If an alarm occurs that is associated with a board point, compressor, condenser, Setpoint, or any other
 numbered object then the Alarm Detail will be a numerical value from 2-334

(See page 86 for Alarm Name)

(See page 88 for Alarm Detail)

#	ALARM NAME
18	LCKOUT RESET

#	ALARM DETAIL
1	N/A

Explanation:

A Lockout Reset was performed

SI Fault Example:

There is an SI fault on the MicroMag at location M-8 Alarm Name = SI FLT @ which is a value of 12
 Alarm Detail = M-8 which is a value of 159

Compressor Fault Example:

(See page 86 for Alarm Name)

(See page 92 for Alarm Detail)

#	ALARM NAME
12	SI FLT @

#	ALARM DETAIL
159	M-8

Explanation:

Sensor Fault at M8 main board

There is a compressor #3 fault.

Alarm Name = CMP Fault which is a value of 27 - Alarm Detail = #3 which is a value of 4

Setpoint Change Example:

(See page 86 for Alarm Name)

(See page 88 for Alarm Detail)

#	ALARM NAME
27	CPM FAULT

#	ALARM DETAIL
4	#3

Explanation:

Compressor Fault #3 - Check
 History to determine fault at time
 of the alarm

There is a Setpoint change at Setpoint #99 Alarm Name = StptChg: which is a value of 7 -
 Alarm Detail = #99 which is a value of 100.

(See page 86 for Alarm Name)

(See page 90 for Alarm Detail)

#	ALARM NAME
7	StptChg

#	ALARM DETAIL
100	#99

Explanation:

Setpoint #99 was changed

MCS-CONNECT monitoring a MICROMAG Controller will show 100 of the latest alarms created by the MICROMAG Controller.

Chapter - 21. MICROMAG BMS ALARMS

MicroMag generates 73 different alarms as shown below. In the first column of the table below, MicroMag starts its numbering with '0' which is 'NO ALARM'. BACnet present value number starts with '1'.

(BACnet will display a number one ahead of the number MicroMag is displaying)

BACNET_MSV_ALARM_1_STATE MSV:110

BACNET_MSV_ALARM_2_STATE MSV:111

BACNET_MSV_ALARM_3_STATE MSV:112

BACNET_MSV_ALARM_4_STATE MSV:113

BACNET_MSV_ALARM_5_STATE MSV:114

MCS/MODBUS RTU	BACnet MS/TP	
Present Value	Present Value	State-Text
0	1	NO ALARM
1	2	UNIT PWR ON
2	3	CYC CT RESET
3	4	RO CHG @
4	5	AO CHG @
5	6	SI CHG @
6	7	StptChg:
7	8	COMM: MCSIO
8	9	COMM: MODBUS
9	10	COMM: BACnet
10	11	PNT INFO CLR
11	12	SI FLT @
12	13	EE WRITE ERR
13	14	MCS IO RESET
14	15	AUTH CODE:
15	16	NET RUN/STOP
16	17	NET OCCUPIED
17	18	LCKOUT RESET
18	19	ALARMS CLEAR
19	20	RO 1 OFFLINE
20	21	RO 2 OFFLINE
21	22	SI 1 OFFLINE
22	23	SI 2 OFFLINE
23	24	EVAP FAN FLT
24	25	NO CMP PRF
25	26	HI MTR TMP
26	27	CMP FAULT
27	28	UNSAFE SUC
28	29	LO SUC PSI
29	30	LO SUC SHT

MCS/MODBUS RTU	BACnet MS/TP	
Present Value	Present Value	State-Text
30	31	HI SUC SHT
31	32	LO DIS PSI
32	33	HI DIS PSI
33	34	HI DIS TMP
34	35	LO DIS SHT
35	36	LO PSI DIF
36	37	UNS PSI DIFF
37	38	OIL LEVEL
38	39	HI OIL TMP
39	40	HIGH AMPS
40	41	LOW AMPS
41	42	PUMP DOWN
42	43	CFG INVALID
43	44	CndFLT @
44	45	HI PSI SW
45	46	LO PSI SW
46	47	HTR FAULT
47	48	HI SupplyTmp
48	49	PHASE LOSS
49	50	HI BLDG PSI
50	51	FILTER CLOG
51	52	CFG RECEIVED
52	53	SMOKE ALARM
53	54	IGNITION FLT
54	55	SPLY FREEZE
55	56	PRECL FREEZE
56	57	NO FLOW
57	58	EMERG. STOP
58	59	STAT OFFLINE
59	60	NO BATTERY
60	61	HI DUCT PSI
61	62	FIRE ALARM
62	63	CONDENSATION
63	64	SWITCHED OFF
64	65	OAD FAULT
65	66	Mod-InputChg
66	67	ModAnalogChg
67	68	Mod-RelayChg
68	69	Mod-ConstChg
69	70	ModConfigChg
70	71	ERW ALARM
71	72	Aux Heat FLT
72	73	PrcsPump FLT
73	74	Low Oil LVL

21.1. MICROMAG ALARMS DETAILS REFERENCE NUMBERS

The below table shows 'ALARMS DETAILS REFERENCE NUMBERS.

BACNET_MSV_ALARM_1_TEXT_STATE MSV:115

BACNET_MSV_ALARM_2_TEXT_STATE MSV:116

BACNET_MSV_ALARM_3_TEXT_STATE MSV:117

BACNET_MSV_ALARM_4_TEXT_STATE MSV:118

BACNET_MSV_ALARM_5_TEXT_STATE MSV:119

MCS/MODBUS RTU	BACnet MS/TP		MicroMag / Set-points /Exp Brds
Present Value	Present Value	State-Text	
0	1	N/A	
1	2	1	
2	3	2	
3	4	3	
4	5	4	
5	6	5	
6	7	6	
7	8	7	
8	9	8	
9	10	9	
10	11	10	
11	12	11	
12	13	12	
13	14	13	
14	15	14	
15	16	15	
16	17	16	
17	18	17	
18	19	18	
19	20	19	
20	21	20	
21	22	21	
22	23	22	
23	24	23	
24	25	24	
25	26	25	
26	27	26	
27	28	27	
28	29	28	
29	30	29	
30	31	30	
31	32	31	

MCS/MODBUS RTU	BACnet MS/TP		MicroMag / Set-points /Exp Brds
Present Value	Present Value	State-Text	
32	33	32	
33	34	33	
34	35	34	
35	36	35	
36	37	36	
37	38	37	
38	39	38	
39	40	39	
40	41	40	
41	42	41	
42	43	42	
43	44	43	
44	45	44	
45	46	45	
46	47	46	
47	48	47	
48	49	48	
49	50	49	
50	51	50	
51	52	51	
52	53	52	
53	54	53	
54	55	54	
55	56	55	
56	57	56	
57	58	57	
58	59	58	
59	60	59	
60	61	60	
61	62	61	
62	63	62	
63	64	63	
64	65	64	
65	66	65	
66	67	66	
67	68	67	
68	69	68	
69	70	69	
70	71	70	
71	72	71	

MCS/MODBUS RTU	BACnet MS/TP		MicroMag / Set-points /Exp Brds
Present Value	Present Value	State-Text	
72	73	72	
73	74	73	
74	75	74	
75	76	75	
76	77	76	
77	78	77	
78	79	78	
79	80	79	
80	81	80	
81	82	81	
82	83	82	
83	84	83	
84	85	84	
85	86	85	
86	87	86	
87	88	87	
88	89	88	
89	90	89	
90	91	90	
91	92	91	
92	93	92	
93	94	93	
94	95	94	
95	96	95	
96	97	96	
97	98	97	
98	99	98	
99	100	99	
100	101	100	
101	102	101	
102	103	102	
103	104	103	
104	105	104	
105	106	105	
106	107	106	
107	108	107	
108	109	108	
109	110	109	

MCS/MODBUS RTU	BACnet MS/TP		MicroMag / Set-points /Exp Brds
Present Value	Present Value	State-Text	
110	111	110	
111	112	111	
112	113	112	
113	114	113	
114	115	114	
115	116	115	
116	117	116	
117	118	117	
118	119	118	
119	120	119	
120	121	120	
121	122	121	
122	123	122	
123	124	123	
124	125	124	
125	126	125	
126	127	126	
127	128	127	
128	129	128	
129	130	129	
130	131	130	
131	132	131	
132	133	132	
133	134	133	
134	135	134	
135	136	135	
136	137	136	
137	138	137	
138	139	138	
139	140	139	
140	141	140	
141	142	141	
142	143	142	
143	144	143	
144	145	144	
145	146	145	
146	147	146	
147	148	147	
148	149	148	

MCS/MODBUS RTU	BACnet MS/TP		MicroMag / Set-points /Exp Brds
Present Value	Present Value	State-Text	
149	150	149	
150	151	150	
151	152	M-1	SENSOR INPUTS Alarm Details V12 MicroMag Main Board
152	153	M-2	
153	154	M-3	
154	155	M-4	
155	156	M-5	
156	157	M-6	
157	158	M-7	
158	159	M-8	
159	160	M-9	
160	161	M-10	
161	162	1-1	SENSOR INPUTS Alarm Details V12 Micro-SI8-A04 Old Expansion Board #1
162	163	1-2	
163	164	1-3	
164	165	1-4	
165	166	1-5	
166	167	1-6	
167	168	1-7	
168	169	1-8	
169	170	2-1	SENSOR INPUTS Alarms Details V12 Micro-SI8-A04 Old Expansion Board #2
170	171	2-2	
171	172	2-3	
172	173	2-4	
173	174	2-5	
174	175	2-6	
175	176	2-7	
176	177	2-8	
177	178	M-T	ANALOG OUTPUTS Alarms Details V12-V18 MicroMag Main Board
178	179	M-1	
179	180	M-2	
180	181	M-3	
181	182	M-4	ANALOG OUTPUTS Alarms Details V12-V18 Micro-SI8-A04 Exp. Board #1
182	183	1-1	
183	184	1-2	
184	185	1-3	
185	186	1-4	ANALOG OUTPUTS Alarms Details V12-V18 Micro-SI8-A04 Exp. Board #2
186	187	2-1	
187	188	2-2	
188	189	2-3	
189	190	2-4	

MCS/MODBUS RTU	BACnet MS/TP		MicroMag / Set-points /Exp Brds
Present Value	Present Value	State-Text	
190	191	M-1	RELAY OUTPUTS Alarms Details V12 MicroMag Main Board
191	192	M-2	
192	193	M-3	
193	194	M-4	
194	195	M-5	
195	196	M-6	
196	197	1-1	RELAY OUTPUTS Alarms Details V12 Micro RO6 Old Exp. Board. #1
197	198	1-2	
198	199	1-3	
199	200	1-4	
200	201	1-5	
201	202	1-6	
202	203	2-1	RELAY OUTPUTS Alarms Details V12 Micro RO6 Old Exp. Board #2
203	204	2-2	
204	205	2-3	
205	206	2-4	
206	207	2-5	
207	208	2-6	
208	209	M-1	SENSOR INPUTS Alarms Details V18 MicroMag Main Board
209	210	M-2	
210	211	M-3	
211	212	M-4	
212	213	M-5	
213	214	M-6	
214	215	M-7	
215	216	M-8	
216	217	M-9	
217	218	M-10	
218	219	1-1	SENSOR INPUTS Alarm Details V18 MCS-SI-Base Expansion Board
219	220	1-2	
220	221	1-3	
221	222	1-4	
222	223	1-5	
223	224	1-6	
224	225	1-7	
225	226	1-8	
226	227	1-9	
227	228	1-10	
228	229	1-11	
229	230	1-12	

MCS/MODBUS RTU	BACnet MS/TP		MicroMag / Set-points /Exp Brds
Present Value	Present Value	State-Text	
230	231	1-13	SENSOR INPUTS Alarm Details V18 MCS-SI-Base Exp, Board
231	232	1-14	
232	233	1-15	
233	234	1-16	
234	235	2-1	SENSOR INPUTS Alarm Details V18 MCS-SI-EXT Exp, Board Mounted to SI-Base
235	236	2-2	
236	237	2-3	
237	238	2-4	
238	239	2-5	
239	240	2-6	
240	241	2-7	
241	242	2-8	
242	243	2-9	
243	244	2-10	
244	245	2-11	
245	246	2-12	
246	247	2-13	
247	248	2-14	
248	249	2-15	
249	250	2-16	
250	251	V-1	
251	252	V-2	
252	253	V-3	
253	254	V-4	
254	255	V-5	
255	256	V-6	
256	257	V-7	
257	258	V-8	
258	259	M-1	
259	260	M-2	RELAY OUTPUTS Alarm Details V18 MicroMag Main Board
260	261	M-3	
261	262	M-4	
262	263	M-5	
263	264	M-6	
264	265	1-1	RELAY OUTPUTS Alarm Details V18 MCS-RO-BASE Expansion Board
265	266	1-2	
266	267	1-3	
267	268	1-4	
268	269	1-5	
269	270	1-6	

MCS/MODBUS RTU	BACnet MS/TP		MicroMag / Set-points /Exp Brds
Present Value	Present Value	State-Text	
270	271	1-7	RELAY OUTPUTS Alarm Details V18
271	272	1-8	
272	273	1-9	
273	274	1-10	MCS-RO-BASE Expansion Board
274	275	2-1	RELAY OUTPUTS Details V18 MCS-RO-EXT Expansion Board Mounted to Base
275	276	2-2	
276	277	2-3	
277	278	2-4	
278	279	2-5	
279	280	2-6	
280	281	2-7	
281	282	2-8	
282	283	2-9	
283	284	2-10	
284	285	151	
285	286	152	
286	287	153	
287	288	154	
288	289	155	
289	290	156	
290	291	157	
291	292	158	
292	293	159	
293	294	160	
294	295	161	
295	296	162	
296	297	163	
297	298	164	
298	299	165	
299	300	166	
300	301	167	
301	302	168	
302	303	169	
303	304	170	
304	305	171	
305	306	172	
306	307	173	
307	308	174	
308	309	175	
309	310	176	

MCS/MODBUS RTU	BACnet MS/TP		MicroMag / Set-points /Exp Brds
Present Value	Present Value	State-Text	
310	311	177	
311	312	178	
312	313	179	
313	314	180	
314	315	181	
315	316	182	
316	317	183	
317	318	184	
318	319	185	
319	320	186	
320	321	187	
321	322	188	
322	323	189	
323	324	190	
324	325	191	
325	326	192	
326	327	193	
327	328	194	
328	329	195	
329	330	196	
330	331	197	
331	332	198	
332	333	199	
333	334	200	
334	335	201	

Chapter - 22. TROUBLESHOOTING QUICK REFERENCE

PROBLEM	POTENTIAL SOLUTION
No Sensor + 5 vdc or sensor +5 vdc output is less than 4.90 vdc.	Indicates a possible shorted input sensor Remove all sensor terminal blocks. Wait about 15 seconds. If + 5 vdc returns, replace one sensor wire at a time until the + 5 vdc is lost again. This will be the shorted sensor.
A Sensor Input reads -99.9	This indicates an open Sensor Input signal or 5 VDC problem. Check sensor wiring for missing wire or poor connection. Check for faulty sensor. Check + 5 vdc on Sensor Input to ground. If less than 5 VDC is on the sensor 5 VDC terminal block, the problem is probably a shorted sensor. (A poly fuse protects the board) Remove all Sensor Input terminals. Wait about 15 seconds or until 5 VDC restored at Sensor Input. Connect terminals 1 at time until short reappears and fix bad sensor.
A Sensor Input reads +999.9	This indicates a shorted Sensor Input signal. Check sensor wiring for +5VDC shorted to signal etc. Check for faulty sensor.
A pressure sensor is reading more than 1 psi off (The temperature and humidity sensors do not require calibration.)	This indicates the transducer Sensor Input needs to be calibrated through the offset capability in the software. (Transducers by design need to be calibrated based on construction and altitude.) You can use the MCS-Connect with a valid Authorization code to change sensor offsets or from MicroMag Keypad. See MCS-Connect Interactive section for instructions. (Change SI Status, Manual Value and / or offset.)
Invalid reading on one Sensor Input.	This indicates an input problem with 1 sensor. Verify jumper settings correct for that SI.
Lost I/O	Indicates communications problem. Verify RS485 LED blinking. Verify termination jumper J6 only on at MicroMag and last I/O. Verify MicroMag and I/O address's set correctly. Verify wiring from MicroMag to each I/O correct. Check fuses/120 VAC on I/O units
MCS-Connect cannot make changes	This indicates you are not at a proper authorization level. Follow steps below for proper authorization From either the SITE INFO or STATUS screen in MCS-Connect, click the 'View Only' button at the top of the screen, or click on the 'Passwords' menu option on the lower right of your Keypad/LCD display. Follow prompts and enter a valid 4-digit authorization number. The authorization level is displayed at the top of the display and is reflected by the color of the Authorization button. Red = View Only Light Blue = User level Purple = Service level Dark Blue = Supervisor level Green = Factory level

PROBLEM	POTENTIAL SOLUTION
Invalid authorization	This indicates an invalid authorization number. Follow steps below for proper authorization Press Menu key until the Password option appears Press the Enter key Follow the instructions in this manual. Section in Keypad labeled Enter Passwords.
SI from AMPS board 10 A low.	This indicates a problem with this SI only. Jumper setting on this SI in wrong position. Incorrect sensor type used.
INVALID CONFIG VER	Indicates layout of CFG wrong. CFG layout for different version than software
INVALID CONFIG TYPE	Indicates CFG incompatible with software.
INVALID CONFIG CHECKSUM	Indicates Checksum invalid Reload a valid CFG
Sensor input believed invalid	Verify Berg jumpers using Quick Reference Sheets Check wiring of sensor
Communications to MCS-485-GATEWAY from MCS-Connect not working.	Verify red LED on the gate way is blinking. This indicates that MCS-Connect is talking to the gateway. Verify that the two wire shielded cable is properly wired from the RS-485 connector to the gateway. Verify red LED (Located just to the left of the RS-485 connector on the MicroMag board is blinking. This indicates that the MicroMag is responding to the gateway. If both of these LED are blinking, check the address of the MicroMag and any other MicroMags that are on the network. Each must have a unique address. This address can be changed from the MicroMag. Proper authorization is required. Enter the UNIT INFORMATION screen by pressing the SERVICE DIAGNOSTIC key and scrolling to this item. Press the enter key and scroll to the NETWORK ADDRESS screen. Change address if needed. Verify + 12 vdc to MCS-485-GATEWAY
INVALID CONFIG	Indicates Checksum invalid Either set to factory defaults on reset settings.

Chapter - 23. MicroMag Chiller Setpoints

Setpoint Information Screen (MicroMag-V18)																
		ACO = Anti-Cycle			ECO = Economizer			EXHS = Exhaust			HP = Heat Pump					
		DH = Dehumidification			EVP = Evaporator			ERW = Energy Recovery Wheel			HD = High Discharge					
#	Name	Value	Min	Max	Adjust Value	Time (SEC)	Max Time Allowed (SEC)	Lockout Delay (HRS)	Safety Down Time(MIN)	Active or Non-Active	Select Value: # decimals & print char	Level Of Auth. To Display	Type of Setpoint	SEC to Ignore Safety	Window to Ext. Safety Time(SEC)	Safety Time Ext. (SEC)
8	COOL TARGET	24	20	28	0.1	---	---	---	---	Active	... TEMP	View Only	Target	---	---	---
9	CoolStepDely	60	30	300	5	---	---	---	---	Active	... SECONDS	View Only	Delay	---	---	---
10	HEAT TARGET	30	18	40	0.1	---	---	---	---	Active	... TEMP	View Only	Target	---	---	---
11	HeatStepDely	120	30	500	5	---	---	---	---	Active	... SECONDS	View Only	Delay	---	---	---

- ▶ **# (Number)** – From 1 to 200 (maximum number of Setpoints supported). Only active Setpoints will be displayed in MCS-CONNECT and on the keypad display.
- ▶ **Name** – The Setpoint's name consists of up to 12 characters. The name is displayed following the number on the LCD display. The Setpoint name cannot be changed in the MICROMAG.
- ▶ **Value** – The value or target of the Setpoint. With proper authorization this value can be changed, within limits that have been established in MCS-Config.
- ▶ **Min** – The minimum value that can be set. This field is not displayed and cannot be changed in MCS-CONNECT or in the keypad display.
- ▶ **Max** – The maximum value that can be set. This field is not displayed and cannot be changed in MCS-CONNECT or in the keypad display.
- ▶ **Adjust Value** – The interval that the value field can be changed by. This field is not displayed and cannot be changed in MCS-CONNECT or in the keypad display.
- ▶ **Time (sec)** – this field has two purposes:

In either a LOCKOUT or ALARM type; this is the length of time the Setpoint must be true before it will trip. This time is always in seconds and it is displayed on the keypad display and MCS-CONNECT if the Setpoint is either a LOCKOUT or ALARM type. This field can be changed in MCS-CONNECT and through the keypad.

In a non-safety type Setpoint this field can be used as an extra timer. This will be specified in the Setpoint definition if it is used.
- ▶ **Max Time Allowed (SEC)** – Maximum time in seconds that the unit can run before lockout.
- ▶ **Lockout Delay Hrs.** – If a second safety occurs within this time, the unit or compressor will be locked out. This field is not displayed and cannot be changed through MCS-CONNECT or in the keypad display.
- ▶ **Safety Down Time (min.)** – After the first safety occurs the MicroMag will wait this number of minutes before the unit or associated compressor is allowed to run again.
- ▶ **Active or Non-Active** – Only active Setpoints will be displayed in MCS-CONNECT or on the keypad display, but only if the needed authorization level has been achieved.
- ▶ **Select Value: # decimals and print char** – This indicates the number of decimal places and the unit character that accompanies the value displayed. The number of decimal places is crucial when the Value, Minimum, and Maximum data is entered in MCS-Config.
- ▶ **Level of Auth. To Display** – This column indicates what authorization level a user must have in order to view the Setpoint from MCS-CONNECT or the keypad display.
- ▶ **Type of Setpoint** – This column indicates what type of setpoint, 'Setpoint, Alarm, Lockout, Time, Target, Delay, Enable, Minimum Capacity or Warning'.
- ▶ **SEC to Ignore Safety** – This is the time in seconds to ignore the associated safety at compressor start up.
- ▶ **Window to Ext. Safety Time (SEC)** – This value in seconds is the time window when the compressor starts that the safety time extension is added to the safety time(sec) value.
- ▶ **Safety Time Ext. (SEC)** – This value is the time that is added to the time(sec) value during the window to extend safety time(sec) time.

23.1. Setpoint Types

There are nine different types of Setpoints. The MicroMag software determines if a Setpoint contains a target value or is a safety. If it is a safety then its type determines what action the MicroMag will take when the safety occurs (either locking out the unit or generating an alarm only).

NOTE: YOU WILL NOTICE THAT WHEN YOU CHOOSE THE ‘TYPE OF SETPOINT’, CERTAIN COLUMNS WILL BECOME ACTIVE WHILE OTHER COLUMNS ARE INACTIVE.

23.1.1 SETPOINT

This type of Setpoint contains a target or provides information for some action. The time element in this type can be used for an additional counter if specified. This time is not displayed and cannot be changed through MCS-CONNECT or from the keypad display.

Name	Value	Min	Max	Adjust Value	Type of Setpoint
COOL ENABLE	22	18	29	0.1	Setpoint

Above columns are active when ‘SETPOINT’ is type, other columns cannot be changed

23.1.2 LOCKOUT

This type of Setpoint contains a safety value and the time that the safety must be violated before the safety will trip. Once a safety has tripped the MicroMag will take the appropriate action, shutting down the entire package or an individual compressor depending on the purpose of the safety. The MicroMag will then wait the Safety Down Time contained in that Setpoint before trying to return the normal. If successful, the system will continue to operate. If a second trip occurs on the same Setpoint with in the Lock Out Delay Time that is contained in that Setpoint the system will move to a LOCK-OUT state. If the lockout delay time is set to zero the lockout will occur on the first trip. This requires manual intervention to reset the system. With each safety trip, the MicroMag will generate an alarm; refer to section 8 MicroMag Alarms and Safeties.

Sec. to ignore safety - If this value is not zero, at compressor startup this safety will be ignored for the time in this field.

Window to extend Safety ‘Time (sec)’ – If this value is not zero, at compressor startup the normal Safety Time will be increased by the value in Safety Time Extension field for the time specified in this field.

Safety Time Extension (Sec) – This is the value that will be added to the Safety Time during the Window to extend Safety Time period.

Name	Value	Min	Max	Adjust Value	Time (SEC)	Max Time Allowed (SEC)	Lockout Delay (HRS)	Safety Down Time(MIN)	Type of Setpoint	SEC to Ignore Safety	Window to Ext. Safety Time(SEC)	Safety Time Ext. (SEC)
COOL ENABLE	22	18	29	0.1	1	1	1	1	Lockout	1	1	1

Above columns are active when ‘LOCKOUT’ is type of setpoint

23.1.3 ALARM

This type of Setpoint has two uses:

1. When it is used as a safety, it will be similar to the LOCKOUT Setpoint except it will never cause a lock out. The system will continue to try returning to normal operation after waiting the safety down time. An ALARM Setpoint type will never require manual intervention to reset the system.
2. When the Setpoint is being used as a second timer it will be available to change in a live unit. If the type is not changed to ALARM then the time field cannot be viewed or changed from a live unit.

Sec. to ignore safety - If this value is not zero, at compressor startup this safety will be ignored for the time in this field.

Window to extend Safety ‘Time (sec)’ – If this value is not zero, at compressor startup the normal Safety Time will be increased by the value in Safety Time Extension field for the time specified in this field.

Safety Time Extension (Sec) – This is the value that will be added to the Safety Time during the Window to extend Safety Time period.

Name	Value	Min	Max	Adjust Value	Time (SEC)	Max Time Allowed (SEC)	Lockout Delay (HRS)	Safety Down Time(MIN)	Type of Setpoint	SEC to Ignore Safety	Window to Ext. Safety Time(SEC)	Safety Time Ext. (SEC)
COOL ENABLE	22	18	29	0.1	1	1	1	1	Alarm	1	1	1

Above columns are active when 'ALARM' is type of setpoint

23.1.4 Time

This type of Setpoint allows the 'Time (SEC)' value to be displayed and modified in a live unit.

Time A (SEC)	Max Time A Allowed (SEC)	Time B (SEC)	Max Time B Allowed (SEC)	Time C (SEC)	Max Time C Allowed (SEC)
0	0	0	0	60	0

Above columns are active when 'TIME' is type of setpoint

23.1.5 Target

This type of set point is used to develop a target with a high and low zone values.

The decimal characteristics of these values are the same as the Value field

Zone MIN – The value of this cell is added to the Value cell to create the high zone value.

Zone MAX – The value of this cell is subtracted from the Value cell to create the low zone value.

Name	Zone Value	Zone MIN	Zone MAX	MAX ROC Value	MAX ROC MIN Limit	MAX ROC MAX Limit	ROC Interval Value	ROC Interval MIN Limit	ROC Interval MAX Limit	Adjust Multiplier Value	Adjust Divider Value
COOL ENABLE	0	0	0	0	0	0	1	1	1	1	1

Above columns are active when 'TARGET' is type of setpoint

23.1.6 Delay

This type of set point is used to develop a target with a high and low zone values.

The decimal characteristics of these values are the same as the Value field

Zone MIN – The value of this cell is added to the Value cell to create the high zone value.

Zone MAX – The value of this cell is subtracted from the Value cell to create the low zone value.

MIN ADJ % Value	MAX ADJ % Value	MIN ADJ % Limit	MAX ADJ % Limit	MIN Capacity % Value	MAX Capacity % Value	MIN Capacity % Limit	MAX Capacity % Limit	Delay Multiplier Value	Delay Divisor Value
0.1	0.1	0.1	0.1	0.1	0.1	0.1	0.1	1	1

Above columns are active when 'DELAY' is type of setpoint

23.1.7 Minimum Capacity

This type will allow adjustments to the 'MIN or MAX ADJ' and 'MIN or MAX CAPACITY VALUES'. The below columns can be adjusted in MCS-CONFIG with type of setpoint.

MIN ADJ % Value	MAX ADJ % Value	MIN ADJ % Limit	MAX ADJ % Limit	MIN Capacity % Value	MAX Capacity % Value	MIN Capacity % Limit	MAX Capacity % Limit	Delay Multiplier Value
0	0	0	0	0	0	0	0	1

Above columns are active when 'MINIMUM CAPACITY is type of setpoint

23.1.8 Warning

A warning alert is made active with this type of setpoint. Adjustments can be made to the following columns in MCS-CONFIG.

Name	Value	Min	Max	Adjust Value	Time (SEC)	Max Time Allowed (SEC)	Lockout Delay (HRS)	Safety Down Time(MIN)	Type of Setpoint	SEC to Ignore Safety	Window to Ext. Safety Time(SEC)	Safety Time Ext. (SEC)
COOL ENABLE	22	18	29	0.1	1	1	1	1	Warning	1	1	1

Above columns are active when **'WARNING'** is type of setpoint

23.1.9 Enable

Additional Columns in MCS-CONFIG will be 'ENABLED' when you choose this setpoint type.

Name	Zone Value	Zone MIN	Zone MAX	MAX ROC Value	MAX ROC MIN Limit	MAX ROC MAX Limit	ROC Interval Value	ROC Interval MIN Limit	ROC Interval MAX Limit	Adjust Multiplier Value	Adjust Divider Value
COOL ENABLE	0.1	0.1	0.1	0.1	0.1	0.1	1	1	1	1	1

Above columns are active when **'ENABLE'** is type of setpoint

23.2. Window/Safety extension

23.2.1 Time and seconds to ignore for setpoints

- **Seconds to ignore** – This is the time in seconds to ignore the associated safety at compressor start up. *The window to extend safety time and safety time extension fields work together.*
- **Window to extend safety** – This value in seconds is the time window when the compressor starts that the **safety time extension** is added to the safety **time(sec)** value.
- **Safety time extension** – This value is the time that is added to the **time(sec)** value during the **window to extend safety time(sec)** time.

Example – Unsafe suction setpoint has a 3 second safety trip. So if we add a 120 to our window to extend safety, we will then be telling the controller at startup we're going to extend that 3 second safety trip for 120 seconds. This is where the Safety time extension comes into play. If we put a 6 in this field we're telling the controller for the first 120 seconds at startup we're extending the safety trip time to 9 seconds (3 second trip plus the 6 second extension). Once the 120 seconds expires we will then revert back to a 3 second trip time for the duration of the compressors run time till the next startup.

System Setup ROs SIs AOs MICRO MAG Circuit Base Circuit SI Setpoints Auth Schedule BMS Points																
Setpoint Information Screen																
C = Anti-Cycle		ECO = Economizer		EXHS = Exhaust		HP = Heat Pump										
= Dehumidification		EVP = Evaporator		ERW = Energy Recovery Wheel		HD = High Discharge										
Name	Value	Min	Max	Adjust Value	Time (SEC)	Max Time Allowed (SEC)	Lockout Delay (HRS)	Safety Down Time(MIN)	Active or Non-Active	Select Value: # decimals & print char	Level Of Auth. To Display	Type of Setpoint	SEC to Ignore Safety	Window to Ext. Safety Time(SEC)	Safety Time Ext. (SEC)	
LOW SUCT PSI	85	75	100	1	180	300	2	0	Active	PSI GAGE	Supervisor L	Lockout	30	600	120	
HP SUCT OFST	20	5	50	1					Active	HUMD or %	Supervisor L	Setpoint				
UNSAFE SUCT	45	35	65	0.5	3	10	2	5	Active	PSI GAGE	View Only	Lockout	3	120	6	

23.3. CALCULATION MADE IN SETPOINTS IN MICROMAG FIRMWARE

Within the MCS-MicroMag system, mathematical calculations and placement of decimal points are handled internally and placed in the fields in the status window of MCS-CONNECT or MCS-KEYPAD.

Some calculations need certain numbers to show the correct value in the TARGET field and to make the correct adjustment to a controlling sensor.

This is true in the Target type of setpoints when we are looking at the Temperature.

For example: If the setpoint is a target setpoint and the value is temperature, the calculation calls for one decimal place and the value is 'F' Fahrenheit or 'C' Celsius in the TARGET field as shown on the right.

IT IS IMPORTANT TO NOTE THAT WHEN ENTERING A NUMBER IN THE ADJUST MULTIPLIER FIELD TO BRING YOUR CONTROLLING SENSOR CLOSER TO THE TARGET YOU NEED TO ADD NUMBERS IN THE 10's because of the one decimal point in the 'TEMP' field.

EXAMPLE: Target is 75° - Controlling Sensor is 85°. There is a 10° difference in the Target and the controlling sensor.

If you want to bring the controlling sensor to be within 5° of the target you would use the following numbers in the 'ADJUST MULTIPLIER' and 'ADJUST DIVISOR'

$$\frac{\text{Difference x Adjust Multiplier}}{\text{Adjust Divisor (I)}} = 10^\circ \times 10 / 2 = 5^\circ \text{ Adjustment}$$

Type	# of Decimals	English	Metric	Mixed C/P
Spare	0			
TEMP	1	F	C	C
PSI GAGE	1	P	B	P
PSI ABS	1	p	b	p
DIGITAL/SW	0			
HUMID or %	1	%	%	%
DEWPOINT	1	D	D	D
ENTHALPY	1	h	h	h
AMPS/CT	1	A	A	A
VOLTS-0 dec	0	V	V	V
VOLTS-1 dec	1	V	V	V
VOLTS-2 dec	2	V	V	V
STATIC-2 dec	2	"	"	"
STATIC-1 dec	1	"	"	"
CYCLES/CFM	0	c	c	c
FPM	0	f	f	f
GAL/MIN	0	G	G	G
RPM'S	0	R	R	R
HOURS	0	H	H	H
MINUTES	0	m	m	m
SECONDS	0	s	s	s
DAYS	0	D	D	D
MAX STP	0	s	s	s
REF LEVEL	1	%	%	%
MTR TEMP	0	F	C	C
METER/LEAK/PP	0	p	p	p
CONDUCTIVITY	0	u	u	u
AMPS/ZERO	0	A	A	A
KW	2	kW	kW	kW
TONS	0	T	T	T
DEC1NOCH	1			
DEC2NOCH	2			

If you are authorized, the adjustments to the controlling sensors can be made using MCS-CONNECT by opening the setpoints tab and clicking in the 'ADJ MULT. AND THE ADJ DIV. FIELDS'.

In the screen shot below, we show our Multiplier and Divisor adjusting the controlling sensor to within 5° of our TARGET as was explained above.

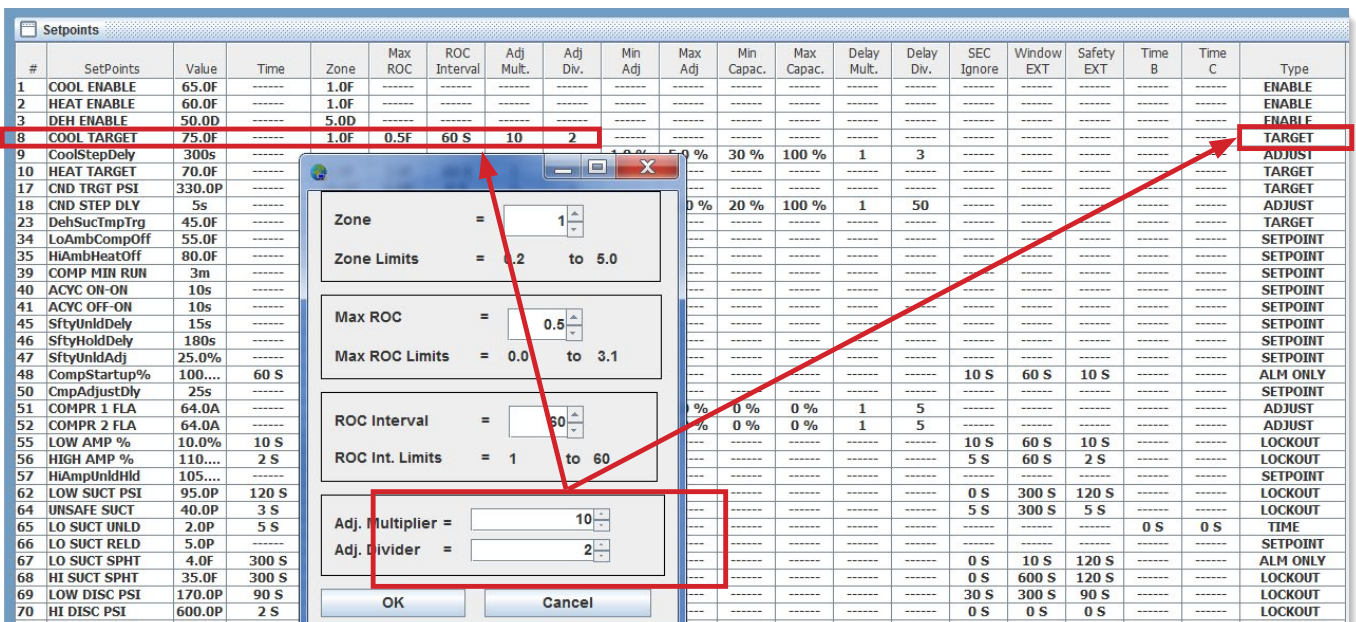

23.4. MicroMag CHILLER SETPOINTS

#	Name	Type	Description
1~7	SPARES		NOT USED
8	CHW Out Target	TARGET	<p>When in Cooling mode the system will maintain this value for the sensor selected.</p> <p>Value: The temperature that Cooling Capacity Control will maintain.</p> <p>Zone: Deadband around target temp.</p> <p>MAX ROC Value: The MAX Rate of Change that the capacity control will allow to determine loading or unloading.</p> <p>ROC Interval: The Time Interval over which the rate of change is calculated.</p> <p>Adjust multiplier/divider value: Scales any calculated changes to the cooling capacity.</p>
9	CHW Step Dely	DELAY	<p>This Setpoint determines how quickly to adjust the cooling capacity. The farther the sensor is from target the quicker the step delay will work to reach the Setpoint.</p> <p>Value: The adjustment delay for the cooling capacity control.</p> <p>MIN Adjust % Value: Cooling capacity will not be adjusted less than this value.</p> <p>MAX Adjust % Value: Cooling capacity will not be adjusted more than this value.</p> <p>MIN Capacity % Value: Cooling capacity will not be less than this value.</p> <p>MAX Capacity % Value: Cooling capacity will not be more than this value.</p> <p>Delay multiplier/divider value: Scales any calculated changes to the cooling step delay.</p>
10~15	SPARES		NOT USED
16	Cool Pre Dly	SETPOINT	<p>When this Setpoint is ACTIVE it will determine the minimum supply fan ON time before going into cooling or heating mode.</p>
17	CND TRGT PSI		<p>When a compressor is running, this Setpoint is the target discharge pressure for the condenser fans.</p> <p>Value: The discharge pressure the condenser capacity control will maintain.</p> <p>Zone: Is the deadband around target psi.</p> <p>MAX ROC Value: The MAX rate of change that the capacity control will allow to determine loading or unloading of condenser fans.</p> <p>ROC Interval: The time Interval that the rate of change is calculated over.</p> <p>Adjust multiplier/divider value: Scales any calculated changes to the Reheating Capacity.</p>

#	Name	Type	Description
18	CND STEP DLY	DELAY	<p>This Setpoint determines how quickly to adjust the condenser fan capacity. The farther the sensor is from target the quicker the step delay will work to reach the Setpoint.</p> <p>Value: The adjustment delay for the condenser fan capacity control.</p> <p>MIN Adjust % Value: Condenser fan capacity will not be adjusted less than this value.</p> <p>MAX Adjust % Value: Condenser fan capacity will not be adjusted more than this value.</p> <p>MIN Capacity % Value: Condenser fan capacity will not be less than this value.</p> <p>MAX Capacity % Value: Condenser fan capacity will not be more than this value.</p> <p>Delay multiplier/divider value: Scales any calculated changes to the Condenser fan step delay.</p>
19~33	SPARE		
34	LoAmbCompOff	ENABLE	<p>If ambient temperature is below this Setpoint, the compressor will be disabled until the ambient temperature reaches the zone value degrees above the value of the Setpoint.</p> <p>Value: The ambient temperature the compressor will be disabled.</p> <p>Zone: The ambient temperature deadband.</p>
		SETPOINT	<p>If ambient temperature is below this Setpoint, the compressor will be disabled until the ambient temperature rises 2 degrees above the value.</p> <p>Value: The ambient temperature the compressor will be disabled.</p>
35	SPARE		NOT USED IN MICROMAG CHILLER
36	SPARE		NOT USED
37	LEAD COMP	ALARM	<p>Identifies the lead compressor. If set to "0" the automatic rotation will be enabled.</p> <p>Value: Lead compressor (If set to "0" automatic rotation will be enabled).</p> <p>Time: If the compressor is in automatic rotation and the value of Setpoint #38 "CompRotation" is set to greater than "0", then compressor will rotate according to run time. If set to "0" the compressors will rotate each cycle.</p>
38	CompRotation	SETPOINT	<p>If compressor rotation is enabled (Value of Setpoint #37 "LEAD COMP" is "0"), then this Setpoint determines the number of days for rotation.</p> <p>Value: The number of days that compressor will be in rotation.</p>
39	COMP MIN RUN	SETPOINT	<p>The minimum number of minutes the compressor must run.</p> <p>Value: The number of minutes the compressor must run before it is allowed to shut off.</p>
40	ACYC ON-ON	SETPOINT	<p>The time difference between the compressor ON cycle and when the compressor can restart. This limits the number of starts per hour.</p> <p>Value: The number of seconds the compressor has to wait before it can turn ON again.</p>
41	ACYC OFF-ON	SETPOINT	<p>The time the compressor must be OFF before restarting.</p> <p>Value: The number of seconds that the compressor must be OFF before it will turn ON.</p>

#	Name	Type	Description
42	PMP DOWN PSI	SETPOINT	If this Setpoint is active the system will PUMP DOWN, running compressors to this Setpoint before turning OFF. A PUMP DOWN is also performed at startup. Value: This is the suction pressure value for turning OFF the compressor when in the PUMP DOWN or for opening the liquid line solenoid during the PRE-PUMP DOWN state.
43	PmpDownDealy	SETPOINT	The PUMP DOWN timer limits the length of time a compressor can be in PUMP DOWN. Value: Specifies the maximum number of seconds that the compressor will remain in PUMP DOWN mode before going into anti-cycle.
		LOCKOUT	The PUMP DOWN timer limits the length of time a compressor can be in PUMP DOWN. If this time is reached, the compressor will lockout. Value: Specifies the maximum number of seconds that the compressor can remain in PUMP DOWN mode. If this time is reached, the compressor will lockout.
44	SERVICE MODE	SETPOINT	If non-zero, then a compressor being disabled by the PUMP DOWN switch will continue to run until its suction pressure is zero. The compressor will be turned ON to perform the PUMP DOWN the number of times indicated in this Setpoint. This is in preparation for service to be performed on the compressor. Value: If the value is zero, then service mode is OFF. IF the value is greater than zero the active compressor will be pumped down to zero PSI this number of times before shutting OFF.
45	SftyUnldDely	SETPOINT	If a compressor is in a safety unload, the compressor will wait this amount between unload adjustments. Value: Seconds between unload adjustments.
46	SftyHoldDely	SETPOINT	This is how long the unit will stay in the safety hold state. Value: Seconds the compressor will stay in safety hold.
47	SftyUnldAdj	SETPOINT	When a compressor is unloading because of safety, this Setpoint will determine the percent of compressor capacity that will be adjusted every unload cycle. Value: The percent the compressor will be adjusted.
48	CompStartup%	SAFETY	This is the starting percent for a compressor whether it is a Digital or Frequency Drive Controlled. Value: The starting compressor speed percentage.
49	SPARE		NOT USED.
50	CmpAdjustDly	SETPOINT	The number of seconds between compressor adjustments. Value: The delay in seconds between compressors adjustments.
51	COMP 1 FLA	SETPOINT	This Setpoint is a reference of the Full Load AMPS for Compressor 1. This value is used to calculate the high and the low amperage safety limits. Value: Full Load AMPS of Compressor 1.
52	COMP 2 FLA	SETPOINT	This Setpoint is a reference of the Full Load AMPS for Compressor 2. This value is used to calculate the high and the low amperage safety limits. Value: Full Load AMPS of Compressor 2.
53	COMP 3 FLA	SETPOINT	This Setpoint is a reference of the Full Load AMPS for Compressor 3. This value is used to calculate the high and the low amperage safety limits. Value: Full Load AMPS of Compressor 3.

#	Name	Type	Description
54	COMP 4 FLA	SETPOINT	<p>This Setpoint is a reference of the Full Load AMPS for Compressor 4. This value is used to calculate the high and the low amperage safety limits.</p> <p>Value: Full Load AMPS of Compressor 4.</p>
55	LOW AMP %	ALARM	<p>This alarm uses the FLA of the compressor to determine what percent the Low Amp alarm is posted. At startup if the motor amperage of the compressor does not achieve this percent, the compressor is shut down and a 'LOW AMPS' Alarm is posted.</p> <p>Value: The value is the LOW AMP percentage for compressors.</p> <p>Time: The number of seconds before the Alarm is tripped.</p> <p>Lockout Delay: The compressor will Lockout if this Alarm occurs more than once within this many hours.</p> <p>Safety Down Time: The amount of time that the compressor will remain in safety when the LOW AMPS Alarm is posted.</p> <p>SEC to Ignore Safety: Will ignore safety for this number of seconds.</p> <p>Window to EXT. Safety Time (SEC): At startup, for the first window to extend Safety Time seconds, allow the Safety Time to be extended.</p> <p>Safety Time Extension (SEC): If Safety Time extension is allowed, extend the Trip Delay by this many seconds.</p>
		LOCKOUT	<p>This alarm uses the FLA of the compressor to determine at what percent the Low Amp alarm is posted. At startup if the motor amps of the compressor do not achieve this percent the compressor will LOCKOUT and a 'LOW AMPS' Alarm is posted.</p> <p>Value: The value is the LOW AMP setting for the compressors.</p> <p>Time: The number of second(s) before the Alarm is tripped and the compressor shall LOCKOUT.</p> <p>SEC to Ignore Safety: Will ignore safety for this number of seconds.</p> <p>Window to EXT. Safety Time (SEC): At startup, for the first window to extend Safety Time seconds, allow the Safety Time to be extended.</p> <p>Safety Time Extension (SEC): If Safety Time extension is allowed, extend the Trip Delay by this many seconds.</p>

#	Name	Type	Description
56	HIGH AMP %	ALARM	<p>This alarm uses FLA of the compressor to determine at what percent the High Amperage alarm is posted. If the motor amps of the compressor rises above this Setpoint, the compressor is shut down and a 'HIGH AMPS' Alarm is posted.</p> <p>Value: The value is the HIGH AMP % setting for compressors.</p> <p>Time: The number of second(s) before the Alarm is tripped.</p> <p>Lockout Delay: The compressor shall Lockout if this Alarm occurs more than once in this many hours.</p> <p>Safety Down Time: The amount of time that the compressor will remain in safety when the HIGH AMPS Alarm is posted.</p> <p>SEC to Ignore Safety: Will ignore safety for this number of seconds.</p> <p>Window to EXT. Safety Time (SEC): At startup, for the first window to extend Safety Time seconds, allow the Safety Time to be extended.</p> <p>Safety Time Extension (SEC): If Safety Time extension is allowed at start up, extend the Trip Delay by this many seconds.</p>
		LOCKOUT	<p>This alarm uses FLA of the compressor to determine at what percent the High Amperage alarm is posted. If the motor amps of the compressor rise above this Setpoint, the compressor shall LOCKOUT and a 'HIGH AMPS' Alarm is posted.</p> <p>Value: The value is the HIGH AMP % setting for the compressors.</p> <p>Time: The number of second(s) before the Alarm is tripped and the compressor will LOCKOUT.</p> <p>SEC to Ignore Safety: Will ignore safety for this number of seconds.</p> <p>Window to EXT. Safety Time (SEC): At startup, for the first window to extend Safety Time seconds, allow the Safety Time to be extended.</p> <p>Safety Time Extension (SEC): If Safety Time extension is allowed at start up, extend the Trip Delay by this many seconds.</p>
57	HiAmpUnldHld	SETPOINT	<p>This Setpoint determines whether a compressor will go into High Amp Hold or Unload due to High Motor Amps. If the motor Amps are above this Setpoint, the compressor will go into High Amp Unloading. Once the current reduces below this Setpoint, the compressor will go into High Amp Hold until the load is below 100%.</p> <p>Value: Load percentage to determine High Amp Unload.</p>

#	Name	Type	Description
58	NoCompProof	ALARM	<p>This Setpoint will shut down a compressor and post a Compressor Proof Alarm if the Compressor Proof SI is not true.</p> <p>Time: The number of seconds before the Alarm is sent.</p> <p>Lockout Delay: The compressor will Lockout if this Alarm occurs more than once in this many hours.</p> <p>Safety Down Time: The compressor will be in safety for this amount of minutes when the NO CMP PRF Alarm is posted.</p> <p>SEC to Ignore Safety: Will ignore safety for this number of seconds.</p> <p>Window to Ext. Safety Time (SEC): At startup, for the first window to extend Safety Time seconds, allow the Safety Time to be extended.</p> <p>Safety Time Extension (SEC): If Safety Time extension is allowed, extend the Trip Delay by this many seconds.</p>
		LOCKOUT	<p>This Setpoint will LOCKOUT a compressor and post a Compressor Proof Alarm, if the Compressor Proof SI is not true.</p> <p>Time: The number of second before the Alarm is tripped and the compressor will LOCKOUT.</p> <p>SEC to Ignore Safety: Will ignore safety for this number of seconds.</p> <p>Window to EXT. Safety Time (SEC): At startup, for the first window to extend Safety Time seconds, allow the Safety Time to be extended.</p> <p>Safety Time Extension (SEC): If Safety Time extension is allowed, extend the Trip Delay by this many seconds.</p>
59	HI MOTOR TMP	SETPOINT	<p>If the high motor temperature input rises above the value of the Setpoint or the digital input turns ON for the time specified in the 'Time (sec)' field, the circuit will be Locked Out and a HIGH MOTOR TEMPERATURE or MOTOR FAULT alarm generated.</p>
60	COMP FAULT	ALARM	<p>This Setpoint will shut down a compressor and post a Compressor Fault Alarm, if the Compressor Fault SI is true.</p> <p>Time: The number of seconds before the Alarm is tripped.</p> <p>Lockout Delay: The compressor shall Lockout if this Alarm occurs more than once in this many hours.</p> <p>Safety Down Time: The compressor will be in safety for this amount of minutes when the CMP FAULT Alarm is posted.</p> <p>SEC to Ignore Safety: Will ignore safety for this number of seconds.</p> <p>Window to EXT. Safety Time (SEC): At startup, for the first window to extend Safety Time seconds, allow the Safety Time to be extended.</p> <p>Safety Time Extension (SEC): If Safety Time extension is allowed, extend the Trip Delay by this many seconds.</p>
		LOCKOUT	<p>This Setpoint will LOCKOUT a compressor and post a Compressor Fault Alarm if the Compressor Fault SI is true.</p> <p>Time: The number of second(s) before the Alarm is tripped and the compressor will LOCKOUT.</p> <p>SEC to Ignore Safety: Will ignore safety for this number of seconds.</p> <p>Window to EXT. Safety Time (SEC): At startup, for the first window to extend Safety Time seconds, allow the Safety Time to be extended.</p> <p>Safety Time Extension (SEC): If Safety Time extension is allowed, extend the Trip Delay by this many seconds.</p>

#	Name	Type	Description
61	COND FAULT	ALARM	This Setpoint will post a COND FAULT Alarm, if the Condenser Fault SI has been tripped for certain amount of time. Value: The number of seconds the Condenser Fault must be tripped before posting a COND FAULT Alarm.
		LOCKOUT	This Setpoint will post a COND FAULT Alarm and LOCKOUT the condensers, if the Condenser Fault SI has been tripped for certain amount of time. Value: The number of seconds the Condenser Fault must be tripped before posting a COND FAULT Alarm setting LOCKOUT of the condensers.
62	LOW SUCT PSI	ALARM	This Alarm uses the Suction Pressure sensor to determine whether a compressor has low suction pressure. If the compressor has low suction pressure, it will be put in Safety and a LO SUC PSI Alarm will be posted. Value: The value is the Low Suction Pressure setting for the Compressors. Time: The number of second(s) before the Alarm is posted. Lockout Delay: The compressor will Lockout if this Alarm occurs more than once in this many hours. Safety Down Time: The amount of time that the compressor will remain in safety when the alarm is posted. SEC to Ignore Safety: Will ignore safety for this number of seconds. Window to EXT. Safety Time (SEC): At startup, for the first window to extend Safety Time seconds, allow the Safety Time to be extended. Safety Time Extension (SEC): If Safety Time extension is allowed during startup, extend the Trip Delay by this many seconds.
		LOCKOUT	This Alarm uses the Suction Pressure sensor to determine whether a compressor has low suction pressure. If the compressor has low suction pressure, it will LOCKOUT and a LO SUC PSI Alarm will be posted. Value: The value is the Low Suction Pressure setting for the Compressors. Time: The number of second(s) before the Alarm is posted and the compressor will LOCKOUT. SEC to Ignore Safety: Will ignore safety for this number of seconds. Window to EXT. Safety Time (SEC): At startup, for the first window to extend Safety Time seconds, allow the Safety Time to be extended. Safety Time Extension (SEC): If Safety Time extension is allowed at startup, extend the Trip Delay by this many seconds.
63	SPARE SETPOINT		

#	Name	Type	Description
64	UNSAFE SUCT	LOCKOUT	<p>This Alarm uses the Suction Pressure sensor to determine whether a compressor has unsafe suction pressure. If the compressor has unsafe suction pressure, it will LOCKOUT and UNSAFE SUC Alarm will be posted.</p> <p>Value: The value is the Unsafe Suction Pressure setting for the Compressors.</p> <p>Time: The number of second(s) before the Alarm is tripped and the compressor will LOCKOUT.</p> <p>SEC to Ignore Safety: Will ignore safety for this number of seconds.</p> <p>Window to EXT. Safety Time (SEC): At startup, for the first window to extend Safety Time seconds, allow the Safety Time to be extended.</p> <p>Safety Time Extension (SEC): If Safety Time extension is allowed at startup, extend the Trip Delay by this many seconds.</p>
65	LO SUCT UNLD	ALARM	<p>This Setpoint will unload compressors with variable capacity to prevent a low suction safety.</p> <p>Value: The PSI above Setpoint #62 "LOW SUCT PSI" in which unloading will be active.</p> <p>Tripped Delay: The number of seconds the compressor will wait before unloading.</p>
66	LO SUCT RELD	SETPOINT	<p>If the system has had a low suction unload, after the safety period, it will reload if the suction pressure has gone above the reload Setpoint.</p> <p>Value: The number of PSI above Setpoint #62 "LOW SUCT PSI" that reload will be active, if unload was active.</p>

#	Name	Type	Description
67	LO SUCT SPHT	ALARM	<p>This Alarm uses the suction superheat calculation to determine whether a compressor has low suction superheat. If the compressor has low suction superheat, it will be put in Safety and a LO SUC SPHT Alarm will be posted.</p> <p>Value: The value is the Low Suction Superheat setting for the Compressors.</p> <p>Time: The number of second(s) before the Alarm is posted.</p> <p>Lockout Delay: The compressor will Lockout if this Alarm occurs more than once in this many hours.</p> <p>Safety Down Time: The amount of time the compressor will remain in safety when the alarm is posted.</p> <p>SEC to Ignore Safety: Will ignore safety for this number of seconds.</p> <p>Window to EXT. Safety Time (SEC): At startup, for the first window to extend Safety Time seconds, allow the Safety Time to be extended.</p> <p>Safety Time Extension (SEC): If Safety Time extension is allowed during startup, extend the Trip Delay by this many seconds.</p>
		LOCKOUT	<p>This Alarm uses the suction superheat calculation to determine whether a compressor has low suction superheat. If the compressor has low suction superheat, it will LOCKOUT and LO SUC SHT Alarm will be posted.</p> <p>Value: The value is the low suction superheat setting for the Compressors.</p> <p>Time: The number of second(s) before the Alarm is tripped and the compressor will LOCKOUT.</p> <p>SEC to Ignore Safety: Will ignore safety for this number of seconds.</p> <p>Window to EXT. Safety Time (SEC): At startup, for the first window to extend Safety Time seconds, allow the Safety Time to be extended.</p> <p>Safety Time Extension (SEC): If Safety Time extension is allowed at startup, extend the Trip Delay by this many seconds.</p>

#	Name	Type	Description
68	HI SUCT SPHT	ALARM	<p>This Alarm uses the suction superheat calculation to determine whether a compressor has high suction superheat. If the compressor has high suction superheat, it will be put in Safety and a HI SUC SPHT Alarm will be posted.</p> <p>Value: The value is the high suction superheat setting for the Compressors.</p> <p>Time: The number of second(s) before the Alarm is posted.</p> <p>Lockout Delay: The compressor will Lockout if this Alarm occurs more than once in this many hours.</p> <p>Safety Down Time: The amount of time the compressor will remain in safety when the alarm is posted.</p> <p>SEC to Ignore Safety: Will ignore safety for this number of seconds.</p> <p>Window to EXT. Safety Time (SEC): At startup, for the first window to extend Safety Time seconds, allow the Safety Time to be extended.</p> <p>Safety Time Extension (SEC): If Safety Time extension is allowed during startup, extend the Trip Delay by this many seconds.</p>
		LOCKOUT	<p>This Alarm uses the suction superheat calculation to determine whether a compressor has high suction superheat. If the compressor has low suction superheat, it will LOCKOUT and HI SUC SHT Alarm will be posted.</p> <p>Value: The value is the high suction superheat setting for the Compressors.</p> <p>Time: The number of second(s) before the Alarm is tripped and the compressor will LOCKOUT.</p> <p>SEC to Ignore Safety: Will ignore safety for this number of seconds.</p> <p>Window to EXT. Safety Time (SEC): At startup, for the first window to extend Safety Time seconds, allow the Safety Time to be extended.</p> <p>Safety Time Extension (SEC): If Safety Time extension is allowed at startup, extend the Trip Delay by this many seconds.</p>

#	Name	Type	Description
69	LOW DISC PSI	ALARM	<p>This Alarm uses the discharge pressure sensor to determine whether a compressor has low discharge pressure. If the compressor has low discharge pressure, it will be put in Safety and a LO DIS PSI Alarm will be posted.</p> <p>Value: The value is the low discharge pressure setting for the Compressors.</p> <p>Time: The number of second(s) before the Alarm is posted.</p> <p>Lockout Delay: The compressor will Lockout if this Alarm occurs more than once in this many hours.</p> <p>Safety Down Time: The amount of time that the compressor will remain in safety when the alarm is posted.</p> <p>SEC to Ignore Safety: Will ignore safety for this number of seconds.</p> <p>Window to EXT. Safety Time (SEC): At startup, for the first window to extend Safety Time seconds, allow the Safety Time to be extended.</p> <p>Safety Time Extension (SEC): If Safety Time extension is allowed during startup, extend the Trip Delay by this many seconds.</p>
		LOCKOUT	<p>This Alarm uses the discharge pressure sensor to determine whether a compressor has low discharge pressure. If the compressor has low discharge pressure, it will LOCKOUT and a LO DIS PSI Alarm will be posted.</p> <p>Value: The value is the Low discharge Pressure setting for the Compressors.</p> <p>Time: The number of second(s) before the Alarm is posted and the compressor will LOCKOUT.</p> <p>SEC to Ignore Safety: Will ignore safety for this number of seconds.</p> <p>Window to EXT. Safety Time (SEC): At startup, for the first window to extend Safety Time seconds, allow the Safety Time to be extended.</p> <p>Safety Time Extension (SEC): If Safety Time extension is allowed at startup, extend the Trip Delay by this many seconds.</p>

#	Name	Type	Description
70	HI DISC PSI	ALARM	<p>This Alarm uses the discharge pressure sensor to determine whether a compressor has high discharge pressure. If the compressor has high discharge pressure, it will be put in Safety and a HI DIS PSI Alarm will be posted.</p> <p>Value: The value is the high discharge pressure setting for the Compressors.</p> <p>Time: The number of second(s) before the Alarm is posted.</p> <p>Lockout Delay: The compressor will Lockout if this Alarm occurs more than once in this many hours.</p> <p>Safety Down Time: The amount of time that the compressor will remain in safety when the alarm is posted.</p> <p>SEC to Ignore Safety: Will ignore safety for this number of seconds.</p> <p>Window to EXT. Safety Time (SEC): At startup, for the first window to extend Safety Time seconds, allow the Safety Time to be extended.</p> <p>Safety Time Extension (SEC): If Safety Time extension is allowed during startup, extend the Trip Delay by this many seconds.</p>
		LOCKOUT	<p>This Alarm uses the discharge pressure sensor to determine whether a compressor has high discharge pressure. If the compressor has high discharge pressure, it will LOCKOUT and a HI DIS PSI Alarm will be posted.</p> <p>Value: The value is the high discharge pressure setting for the Compressors.</p> <p>Time: The number of second(s) before the Alarm is posted and the compressor will LOCKOUT.</p> <p>SEC to Ignore Safety: Will ignore safety for this number of seconds.</p> <p>Window to EXT. Safety Time (SEC): At startup, for the first window to extend Safety Time seconds, allow the Safety Time to be extended.</p> <p>Safety Time Extension (SEC): If Safety Time extension is allowed at startup, extend the Trip Delay by this many seconds.</p>
71	HI DISC UNLD	ALARM	<p>This Setpoint will unload compressors with variable capacity to prevent a high discharge pressure safety.</p> <p>Value: The PSI below Setpoint #70 "HI DISC PSI" in which unloading will be active.</p> <p>Tripped Delay: The number of seconds the compressor will wait before unloading.</p>
72	HI DISC RELD	SETPOINT	<p>If the system has had a high discharge pressure unload, after the safety period, it will reload if the discharge pressure has gone below the reload Setpoint.</p> <p>Value: The number of PSI below Setpoint #70 "HI DISC PSI" that reload will be active, if unload was active.</p>

#	Name	Type	Description
73	HI DISC TEMP	ALARM	<p>This Alarm uses the discharge temperature sensor to determine whether a compressor has high discharge temperature. If the compressor has high discharge temperature, it will be put in Safety and a HI DISC TEMP Alarm will be posted.</p> <p>Value: The value is the high discharge temperature setting for the Compressors.</p> <p>Time: The number of second(s) before the Alarm is posted.</p> <p>Lockout Delay: The compressor will Lockout if this Alarm occurs more than once in this many hours.</p> <p>Safety Down Time: The amount of time that the compressor will remain in safety when the alarm is posted.</p> <p>SEC to Ignore Safety: Will ignore safety for this number of seconds.</p> <p>Window to EXT. Safety Time (SEC): At startup, for the first window to extend Safety Time seconds, allow the Safety Time to be extended.</p> <p>Safety Time Extension (SEC): If Safety Time extension is allowed during startup, extend the Trip Delay by this many seconds.</p>
		LOCKOUT	<p>This Alarm uses the discharge temperature sensor to determine whether a compressor has high discharge temperature. If the compressor has high discharge temperature, it will LOCKOUT and a HI DISC TEMP Alarm will be posted.</p> <p>Value: The value is the high discharge temperature setting for the Compressors.</p> <p>Time: The number of second(s) before the Alarm is posted and the compressor will LOCKOUT.</p> <p>SEC to Ignore Safety: Will ignore safety for this number of seconds.</p> <p>Window to EXT. Safety Time (SEC): At startup, for the first window to extend Safety Time seconds, allow the Safety Time to be extended.</p> <p>Safety Time Extension (SEC): If Safety Time extension is allowed at startup, extend the Trip Delay by this many seconds.</p>
74	DiscTmpUnld	ALARM	<p>This Setpoint will unload compressors with variable capacity to prevent a high discharge temperature safety.</p> <p>Value: The temperature below Setpoint #70 "HI DISC TEMP" in which unloading will be active.</p> <p>Tripped Delay: The number of seconds the compressor will wait before unloading.</p>
75	DiscTmpReld	SETPOINT	<p>If the system has had a high discharge pressure temperature unload, after the safety period, it will reload if the discharge temperature has gone below the reload Setpoint.</p> <p>Value: The number of degrees below Setpoint #73 "HI DISC TEMP" that reload will be active, if unload was active.</p>

#	Name	Type	Description
76	LO DISC SPHT	ALARM	<p>This alarm uses the discharge superheat calculation to determine when a compressor has low discharge superheat. If the compressor has low discharge superheat, it will be put in Safety and a LO DIS SHT Alarm will be posted.</p> <p>Value: The value is the Low Discharge Superheat setting for the Compressors.</p> <p>Time: The number of second(s) before the Alarm is posted.</p> <p>Lockout Delay: The compressor will Lockout if this Alarm occurs more than once in this many hours.</p> <p>Safety Down Time: The amount of time the compressor will remain in safety when the alarm is posted.</p> <p>SEC to Ignore Safety: Will ignore safety for this number of seconds.</p> <p>Window to EXT. Safety Time (SEC): At startup, for the first window to extend Safety Time seconds, allow the Safety Time to be extended.</p> <p>Safety Time Extension (SEC): If Safety Time extension is allowed during startup, extend the Trip Delay by this many seconds.</p>
		LOCKOUT	<p>This Alarm uses the discharge superheat calculation to determine whether a compressor has low discharge superheat. If the compressor has low discharge superheat, it will LOCKOUT and LO DIS SHT Alarm will be posted.</p> <p>Value: The value is the low discharge superheat setting for the Compressors.</p> <p>Time: The number of second(s) before the Alarm is tripped and the compressor will LOCKOUT.</p> <p>SEC to Ignore Safety: Will ignore safety for this number of seconds.</p> <p>Window to EXT. Safety Time (SEC): At startup, for the first window to extend Safety Time seconds, allow the Safety Time to be extended.</p> <p>Safety Time Extension (SEC): If Safety Time extension is allowed at startup, extend the Trip Delay by this many seconds.</p>
77	DisSprhtUnld	SETPOINT	<p>This Setpoint will unload compressors with variable capacity to prevent a low superheat safety.</p> <p>Value: The discharge superheat setting for the Compressors.</p> <p>Tripped Delay: The number of seconds the compressor will wait before unloading.</p>
78	DisSprhtReId	SETPOINT	<p>If the system has experienced a discharge superheat unload, after the safety period, it will reload if the discharge superheat has gone above the reload Setpoint.</p> <p>Value: The discharge superheat setting for the compressors to reload.</p>

#	Name	Type	Description
79	LOW DIFF PSI	ALARM	<p>This Alarm uses the differential pressure between the suction and the oil pressure to determine whether a compressor has low differential pressure. If the compressor has low differential pressure, it will be put in Safety and a LO DIF PSI Alarm will be posted.</p> <p>Value: The value is the low differential pressure setting for the Compressors.</p> <p>Time: The number of second(s) before the Alarm is posted.</p> <p>Lockout Delay: The compressor will Lockout if this Alarm occurs more than once in this many hours.</p> <p>Safety Down Time: The amount of time the compressor will remain in safety when the alarm is posted.</p> <p>SEC to Ignore Safety: Will ignore the safety for this number of seconds.</p> <p>Window to EXT. Safety Time (SEC): At startup, for the first window to extend Safety Time seconds, allow the Safety Time to be extended.</p> <p>Safety Time Extension (SEC): If Safety Time extension is allowed during startup, extend the Trip Delay by this many seconds.</p>
80	UnsafeDifPSI	LOCKOUT	<p>This Alarm uses the differential pressure between the suction and the discharge to determine whether a compressor has low differential pressure. If the compressor has low differential pressure, it will LOCKOUT and a LO DIF PSI Alarm will be posted.</p> <p>Value: The value is the unsafe differential pressure setting for the Compressors.</p> <p>Time: The number of second(s) before the Alarm is posted and the compressor will LOCKOUT.</p> <p>SEC to Ignore Safety: Will ignore safety for this number of seconds.</p> <p>Window to EXT. Safety Time (SEC): At startup, for the first window to extend Safety Time seconds, allow the Safety Time to be extended.</p> <p>Safety Time Extension (SEC): If Safety Time extension is allowed at startup, extend the Trip Delay by this many seconds.</p>
81	HI PSI SW	ALARM	<p>This Setpoint will shut down a compressor and post a HI PSI SW Alarm, if the Compressor High SI Off input is true.</p> <p>Time: The number of seconds before the Alarm is tripped.</p> <p>Lockout Delay: The compressor shall Lockout if this Alarm occurs more than once in this many hours.</p> <p>Safety Down Time: The compressor will be in safety for this amount of minutes when the HI PSI SW Alarm is posted.</p> <p>SEC to Ignore Safety: Will ignore safety for this number of seconds.</p> <p>Window to EXT. Safety Time (SEC): At startup, for the first window to extend Safety Time seconds, allow the Safety Time to be extended.</p> <p>Safety Time Extension (SEC): If Safety Time extension is allowed, extend the Trip Delay by this many seconds.</p>
		LOCKOUT	<p>This Setpoint will LOCKOUT a compressor and post a HI PSI SW if the High SI Off Fault SI is true.</p> <p>Time: The number of second(s) before the Alarm is tripped and the compressor will LOCKOUT.</p> <p>SEC to Ignore Safety: Will ignore safety for this number of seconds.</p> <p>Window to EXT. Safety Time (SEC): At startup, for the first window to extend Safety Time seconds, allow the Safety Time to be extended.</p> <p>Safety Time Extension (SEC): If Safety Time extension is allowed, extend the Trip Delay by this many seconds.</p>

#	Name	Type	Description
82	LO PSI SW	ALARM	<p>This Setpoint will shut down a compressor and post a LO PSI SW Alarm, if the Compressor Low SI Off input is true.</p> <p>Time: The number of seconds before the Alarm is tripped.</p> <p>Lockout Delay: The compressor shall Lockout if this Alarm occurs more than once in this many hours.</p> <p>Safety Down Time: The compressor will be in safety for this amount of minutes when the LO PSI SW Alarm is posted.</p> <p>SEC to Ignore Safety: Will ignore safety for this number of seconds.</p> <p>Window to EXT. Safety Time (SEC): At startup, for the first window to extend Safety Time seconds, allow the Safety Time to be extended.</p> <p>Safety Time Extension (SEC): If Safety Time extension is allowed, extend the Trip Delay by this many seconds.</p>
		LOCKOUT	<p>This Setpoint will LOCKOUT a compressor and post a LO PSI SW if the "Low SI Off" Fault SI is true.</p> <p>Time: The number of second(s) before the Alarm is tripped and the compressor will LOCKOUT.</p> <p>SEC to Ignore Safety: Will ignore safety for this number of seconds.</p> <p>Window to EXT. Safety Time (SEC): At startup, for the first window to extend Safety Time seconds, allow the Safety Time to be extended.</p> <p>Safety Time Extension (SEC): If Safety Time extension is allowed, extend the Trip Delay by this many seconds.</p>
83	PhasLossRset	ALARM	<p>This alarm will Temporarily shut down the entire unit when a phase loss has occurred.</p> <p>Value: the number of seconds after the input is energized before the unit will be disabled.</p> <p>Safety Down Time: The number of minutes the phase loss must be off before the unit is reactivated.</p>
		LOCKOUT/ SETPOINT	<p>This lockout/Setpoint will shut down the entire unit when a phase loss has occurred.</p> <p>Value: the number of seconds after the input is energized before the unit will be locked out.</p> <p>Note: If this value is inactive then the Setpoint will be 2 seconds.</p>
84	SPARE		NOT USED

#	Name	Type	Description
85	HiSupplyTmp	ALARM	<p>This alarm will temporarily disable the heating when the supply temperature sensor reaches Setpoint.</p> <p>Value: The value is the high supply temperature setting for the heating.</p> <p>Time: The number of second(s) before the Alarm is posted.</p> <p>Safety Down Time: The amount of time that the heating will remain in safety when the alarm is posted.</p> <p>Window to EXT. Safety Time (SEC): At startup, for the first window to extend Safety Time seconds, allow the Safety Time to be extended.</p> <p>Safety Time Extension (SEC): If Safety Time extension is allowed during startup, extend the Trip Delay by this many seconds.</p>
		LOCKOUT	<p>This alarm will disable the heating when the supply temperature sensor reaches Setpoint.</p> <p>Value: The value is the high supply temperature setting for the heating.</p> <p>Time: The number of second(s) before the Alarm is posted.</p> <p>Safety Down Time: The amount of time that the heating will remain in safety when the alarm is posted.</p> <p>SEC to Ignore Safety: Will ignore safety for this number of seconds.</p> <p>Window to EXT. Safety Time (SEC): At startup, for the first window to extend Safety Time seconds, allow the Safety Time to be extended.</p> <p>Safety Time Extension (SEC): If Safety Time extension is allowed during startup, extend the Trip Delay by this many seconds.</p>
86	FREEZE TEMP	ALARM	<p>If the supply air temperature goes below this value for the FREEZE TEMP's time then the alarm is posted.</p> <p>Value: The value is the supply air temperature to cause the alarm</p> <p>Lockout Delay: The compressor shall Lockout if this Alarm occurs more than once in this many hours.</p> <p>Safety Down Time: The amount of time that the heating will remain in safety when the alarm is posted.</p> <p>Window to EXT. Safety Time (SEC): At startup, for the first window to extend Safety Time seconds, allow the Safety Time to be extended.</p> <p>Safety Time Extension (SEC): If Safety Time extension is allowed during startup, extend the Trip Delay by this many seconds.</p>
		LOCKOUT	<p>Value: The value is the supply air temperature to cause the lockout</p> <p>Time: The number of second(s) before the Alarm is posted.</p> <p>Safety Down Time: The amount of time that the heating will remain in safety when the alarm is posted.</p> <p>SEC to Ignore Safety: Will ignore safety for this number of seconds.</p> <p>Window to EXT. Safety Time (SEC): At startup, for the first window to extend Safety Time seconds, allow the Safety Time to be extended.</p> <p>Safety Time Extension (SEC): If Safety Time extension is allowed during startup, extend the Trip Delay by this many seconds.</p>
87-88	SPARE		
89	CFG TEST = 0	SETPOINT	<p>If this value is "0" this Setpoint prevents lockout of the controller when communication is lost. This is primarily used for testing purposes.</p>
90	HPLowAmbDsbl	TARGET	<p>This Setpoint will prevent the compressor from running in heat pump when the ambient temperature is below this Setpoint's value.</p> <p>Value: the ambient temperature.</p>
91	RevValveDely	SETPOINT	<p>This Setpoint will delay the rev valve when there is a call for heat pump. It also delays the rev valve when it goes from heat pump to cooling.</p> <p>Value: The number in seconds the compressor is delayed.</p>

#	Name	Type	Description
92	HPAmbDsblDef	SETPOINT	This Setpoint will prevent the system from going into defrost when the ambient is above the setting. Value: The ambient temperature settings to disable defrost.
93	DEF TERM TMP	SETPOINT	This Setpoint will terminate the defrost cycle when the input reaches this setting during a defrost. Value: the temperature where the defrost is terminated.
94	MaxDefRunTim	SETPOINT	Once a defrost is enabled this Setpoint limits the amount of time the system will remain in defrost. Value: the maximum number of minutes the system can remain in the defrost cycle.
95	WtdDefDur % The % of stpt 94	SETPOINT	This Setpoint is the target defrost time based on the percentage of the Maximum Defrost Run Time. Value: the percentage of the MaxDefRunTime that the system will work to remain in defrost. Ex: Stpt 94 = 10 mins with stpt 95 = 90% duration is 9-10 mins needed.
96	BtweenDefAdj	SETPOINT	This Setpoint adjusts the delay between defrosts based on whether the system terminated early on temperature or later on time. Value: duration of seconds to adjust the time between defrosts. Is added to thr setpoint 97 dly between defrost. If we don't reach 90% and come out of defrost before, and if we go all the way to 100% and come out of defrost before, and if we go all the way to 100% than subtract.
97	DelayBtwnDef	SETPOINT	Upon startup, this Setpoint is the initial time in minutes between defrost cycles.
98	HPCndTrgOfst	TARGET	When in heat pump enabled, this target modifies the condenser fan cycling (outdoor coil) target pressure. Value: the pressure to offset Setpoint #17 "Condenser Target PSI" when the unit is in heat pump mode and the reversing valve is on. Zone: the pressure to offset Setpoint #17 "Condenser Target PSI" by when the unit is defrosting.
99	MaxTrgtReset	TARGET	This Setpoint limits the target reset allowed by the BMS. Value: the max/min cooling target reset allowed. Zone: the max/min heating target reset allowed. Max ROC: the max/min dehumidification target reset percentage allowed.
100-113	SPARE		
114	PRECOOL TARG	TARGET	When in Precooling is active, the system will maintain this value for the precooling control sensor selected. Value: The temperature that Precooling Capacity Control will maintain. Zone: Will adjust the capacity control to maintain the temperature and target range for Precooling. MAX ROC Value: The MAX Rate of Change that the capacity control will allow to determine loading or unloading. ROC Interval: The Time Interval over which the rate of change is calculated. Adjust multiplier/divider value: Scales any calculated changes to the cooling capacity.

#	Name	Type	Description
115	PRECOOL ADJ	DELAY	<p>This Setpoint determines how quickly to adjust the precooling capacity. The farther the sensor is from target the quicker the precool Adjust will work to reach the Setpoint.</p> <p>Value: The adjustment delay for the precooling capacity control.</p> <p>MIN Adjust % Value: Precooling capacity will not be adjusted less than this value.</p> <p>MAX Adjust % Value: Precooling capacity will not be adjusted more than this value.</p> <p>MIN Capacity % Value: Precooling capacity will not be less than this value.</p> <p>MAX Capacity % Value: Precooling capacity will not be more than this value.</p> <p>Delay multiplier/divider value: Scales any calculated changes to the precooling step delay.</p>
116-119	SPARES		
120	NO FLOW	SETPOINT	If a proof of air flow switch is present, then NO FLOW should be programmed as a Setpoint. Creates an alarm if air flow has not been proved for a number of second equal to the value of the Setpoint.
121-131	SPARES		
132	EXV TARGET	TARGET	<p>EXV control is bases on superheat. Valve is the target the MicroMag will control from.</p> <p>Zone: is the dead band around the superheat target.</p> <p>Max Roc Value: The max froc that the EXV control will allow to determine opening or closing of the EXV.</p> <p>ROC Interval: The time interval the roc is calculated over.</p> <p>Adjust Mult/Div: Scales any calc. changes to EXV value based on controlling SI'S proximity to the target.</p>
133	EXV ADJUST	DELAY	<p>Determines how quickly to adjust the EXV valve percentsage. The farther the superheat is from the tasrget the quicker the step delay will work to reach setpoint.</p> <p>Min Adjust % Value: EXV value % will not be adjusted fgreaer than this value.</p> <p>Max Adjust Valve %: EXV valve % will not be adjusted gresater than this value.</p> <p>Min Cap %: EXV min % position.</p> <p>Max Cap %: EXV max % position.</p> <p>Delay M/O: Scales calc changes to EXV step delay.</p>
134	EXV LO SPRHT	TIME	If calc superheat remains below this value a safety trip occurs.
135	EXV MOP TARG	TARGET	<p>Value is max suct PSI that EXV control will allow before closing off valve.</p> <p>Zone: DB around target PSI.</p> <p>ROC: Setting are the same.</p> <p>Adjust M/O: Scales calc changes to EXV % based on MOP target controlling PSI's proximity.</p>

#	Name	Type	Description
136	FIRE ALARM	SETPOINT	This alarm will temporarily shut down the entire unit when a fire alarm trip has occurred. Value: the number of seconds after the input is energized before the unit will be disabled. Safety Down Time: The number of minutes the smoke alarm must be off before the unit is reactivated.
137	CONDSATN ALM	SETPOINT	
138-142	SPARES		NOT USED
143	HGB CONTROL V18.00 F and later	Target	Offset to control the HGB RO base on temperature. The STPT_HGB_CONTROL has to be set as Target Type , and the Select Value in TEMP The Value needs to be enter in a negative number, to set the offset to turn on the HGB RO If the cooling_target_SI is less than the cooling target setpoint plus the STPT_HGB_CONTROL value, the HGB RO will turn ON Zone value will set the offset to turn off the HGB RO If the cooling_target_SI is greater than the cooling target setpoint plus the STPT_HGB_CONTROL zone value, the HGB RO will turn OFF. If the LLSRO is OFF the HGB RO will be OFF as well
144	PrcsPumpTarg	Target	Value field - represents the target to control to. Zone Value – Zone built around target MAX ROC Value – Compares the control value rate of change. Maximum positive & negative Rate of Change allowed before preventing the pump from unloading or loading. If the ROC is greater than this value the pump state is set to HOLDING. ROC Interval Value – Amount of time in seconds to look at the ROC. Adj Mult/Div – Changes how aggressive the changes are to the wanted % each time capacity changes. <ul style="list-style-type: none"> • This setpoint must have the correct “Select Value: # decimals & print char” selected. If you’re controlling to temperature you must select “TEMP”. If you’re controlling to PSI you must select “PSI GAGE” or “PSI ABS”. • For pressure differential you must have both an input and output sensor selected under the process control section in config. • For temperature control you will place the controlling sensor in the “Pump Input SI” box and leave the “Pump Output SI” box to “Not Used”
145	PrcsPumpAdj	Delay	Value field represents the time delay between adjustments to the AO Min ADJ % - Minimum adjust allowed to capacity changes. Max ADJ % - Maximum adjust allowed to capacity changes. Min Capacity% - Indicates the minimum speed allowed. This is also the speed set when the pump is first turned on. Max Capacity% - Indicates the maximum speed allowed. Adj Mult/Div – Changes how aggressive the changes are to the process pump step delay count down.
146	EXV LOAD ADJ		NOT USE IN MICROMAG CHILLER
147	DisPsiHtTape		NOT USE IN MICROMAG CHILLER
148	OIL LEVEL		NOT USE IN MICROMAG CHILLER

#	Name	Type	Description
149	LeadPmpRotat	Target	<p>If Setpoint #149 value is zero, then rotation of the pumps will occur whenever the lead pump is turned off. If no pump rotations have occurred within the amount of days specified in the zone field the controller will shut down the chiller and do a forced pump rotation at midnight the day a forced rotation takes place on. If the zone field is 0 no forced rotation will take place.</p> <p>If Setpoint #149 value is non-zero, then rotation of the pumps is inactive and the value will specify the lead pump. This Setpoint can be changed in a live unit and the appropriate action will be taken.</p> <p>Zone – Determines the number of days in between a forced pump rotation if no automatic rotations have occurred.</p>
150-200	SPARES		NOT USED

23.5. Revision Page

Date	Author	Description of Changes
03-24-16	DEW	Created MicroMag Chiller Manual Rev1.0
03-29/4-6-16	DEW	Updates from Justin
04-21-16	DEW	Edits from Justin
05-05-06-16	DEW	Edits from Brian
05-17-16	DEW	Edits from Brian
10-25-16	DEW	Update Graph Section
11-18-16	DEW	Update expansion boards
02/16/17	DEW	Update setpoint Multiplier
06-16-17	DEW	Add BMS Alarm Chart
05-30-18	DEW	Add New Variable Speed Process Pump Control
01-14-19	DEW	Make changes to BMS Section as per Max
05-15-19	DEW	Made changes to setpoints - 146-148
12-06-19	DEW	Show Authorization page before Menus- example how to change setpoints
05-01~28-2020	DEW	BACnet MSV UNIT STATE MSV:0 as FH
06-01-2020	DEW	Convert to Indesign Blk, add BMS Section
06-17-2020	DEW	Add Chilled Water Pump info Lead-Lag, add setpoint 149
06-02-2021	DEW	Add Admin level to Authorization Function
06-16-28-2021	DEW	Changes from MicroMag Getting Started Manual Ver 1.0



Providing HVAC/R Control Solutions Worldwide

5580 Enterprise Pkwy. Fort Myers, FL 33905

Office: (239) 694-0089

Fax: (239) 694-0031

www.mcscontrols.com