

MAG-KEYPAD-DOOR

MICRO CONTROL SYSTEMS Inc.	
Date:	10/23/15 Page 1 of 1
Drawn by:	M. Schreiber
Rev. #:	D
Dwg. Name:	MAG-KEYPAD-DOOR
Part #:	14-099-D

Metal Thickness - 0.093"
 Finish - Gray Powder Coat
 038/70046
 Metal Material Type: 5052-H32 Aluminum

BILL OF MATERIALS						
PART NO.	QTY	PART NAME	MANUFACTURER	PART SYMBOL	PART NUMBER	SPECIFICATIONS
1	1	MAG-KEYPAD-DOOR	-	-	-	7.25" x 8.5" x 0.5" Metal Thickness is 0.093"
2	-	Drylac Powder Coating Paint	Tiger Drylec	-	038/70046	RAL 7040 Gray
3	16	Studs for Mounting Keypad and MAG-KEYPAD-DOOR	PEM	(A8)	FHA-632-8	#6-32 x (0.500" Length)

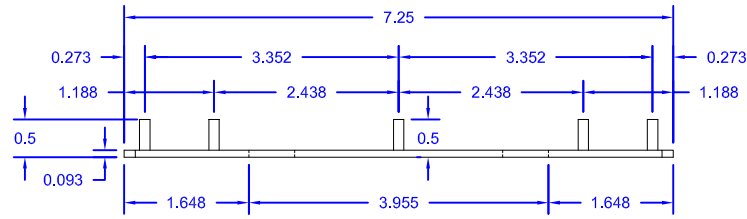

TOP SIDE
VIEW OF MAG-KEYPAD-DOOR

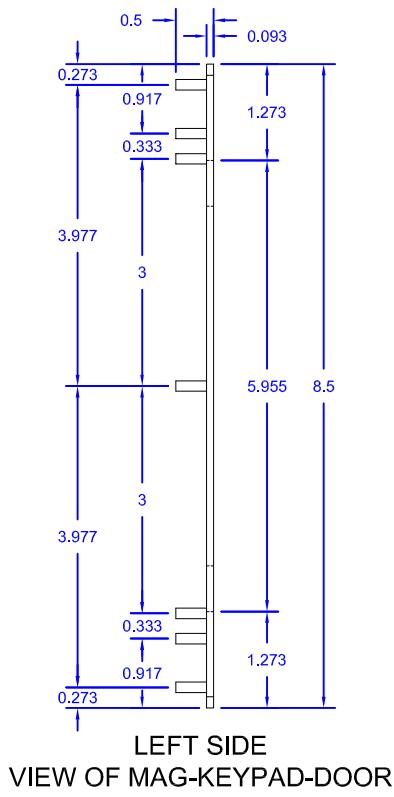

LEFT SIDE
VIEW OF MAG-KEYPAD-DOOR

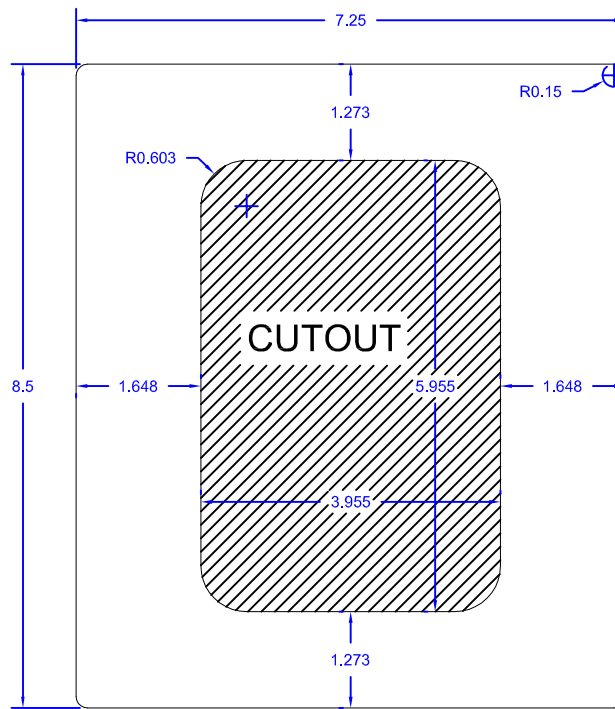

FRONT SIDE
VIEW OF MAG-KEYPAD-DOOR

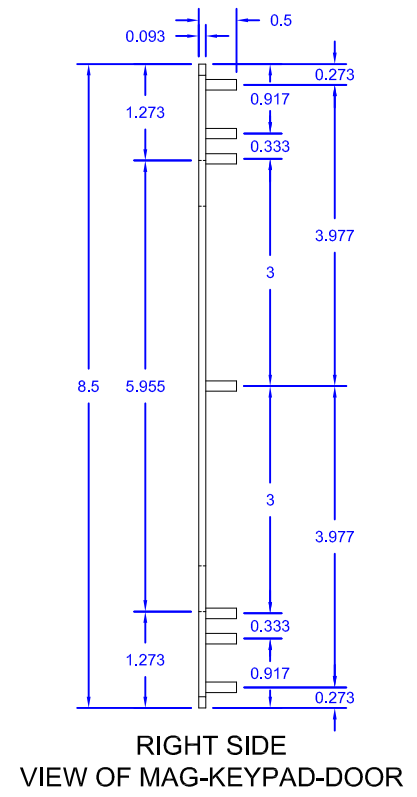

RIGHT SIDE
VIEW OF MAG-KEYPAD-DOOR

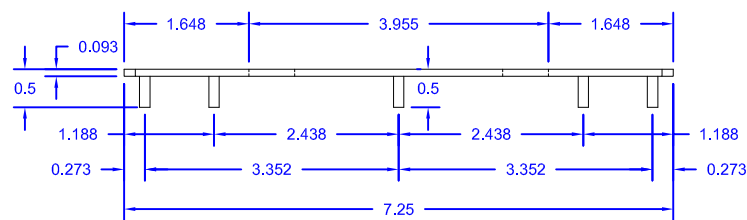

BOTTOM SIDE
VIEW OF MAG-KEYPAD-DOOR

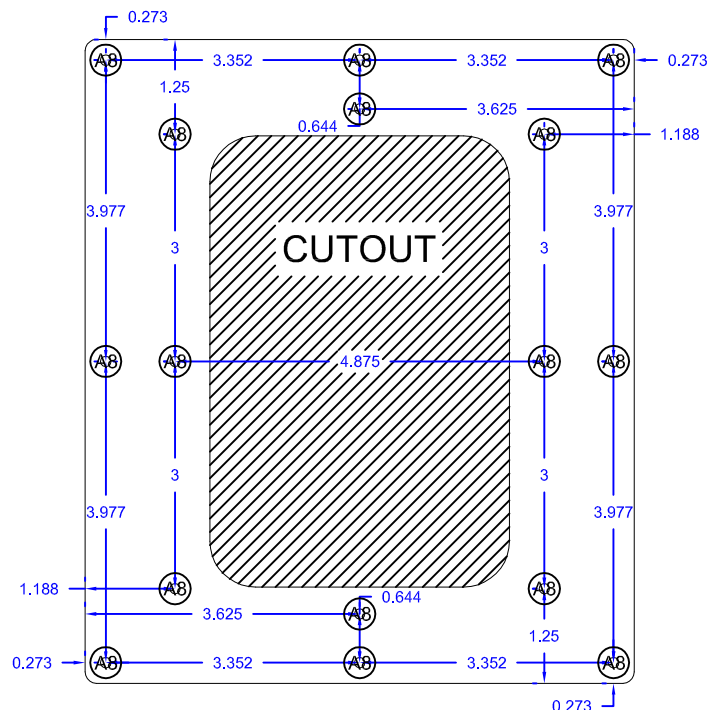

BACK SIDE
VIEW OF MAG-KEYPAD-DOOR

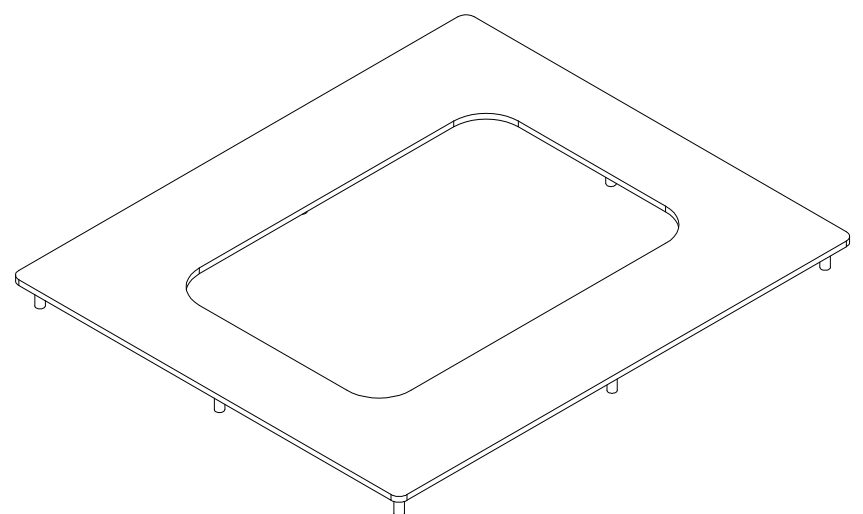
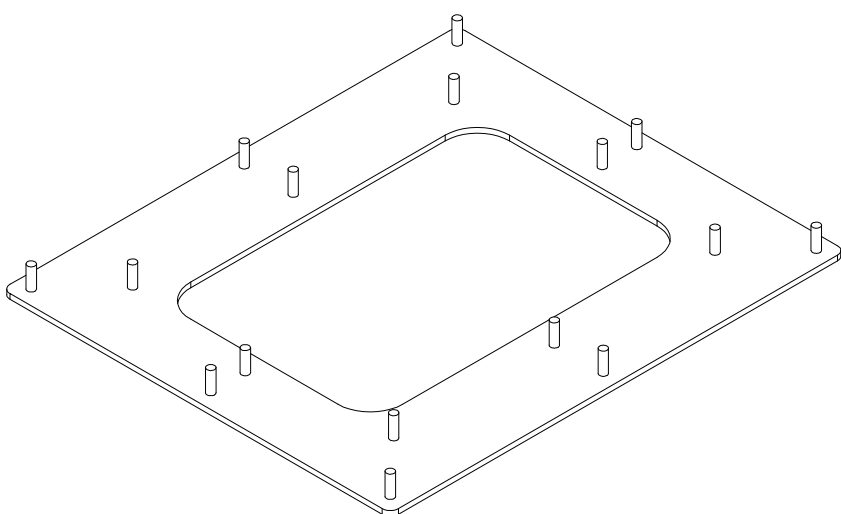

SOUTHWEST ISOMETRIC
VIEW OF MAG-KEYPAD-DOOR