

No.	Name	Note	No.	Name	Note
1	Angle valve	1/4" Flare	13	Angle valve	1/4" Flare
2	Discharge flange	4"	14	Refrigerant service valve	1/4" Flare
3	Solenoid valve	50%(NC)	15	Solenoid valve	Stepless(NC or NO), Option
4	Solenoid valve	75%(NC)	16	Liquid injection connector	5/8" Flare, Option
5	Solenoid valve	35%(NC)	17	Suction flange	5"
6	Liquid(oil or refrigerant) injection connector	3/8" Flare, Option	18	Cable box	Standard
7	Capillary		19	Service flange	
8	Check valve	4"	20	Oil drain valve	Option
9	Oil flow sight glass		21	Discharge temp. sensor	110°C
10	Service flange		22	Safety Valve	1" NPT, Option
11	Stop pin		23	Economizer port	1 1/8", Solder
12	Oil inlet Connector	3/4" Flare			

***All stop valves are optional.**

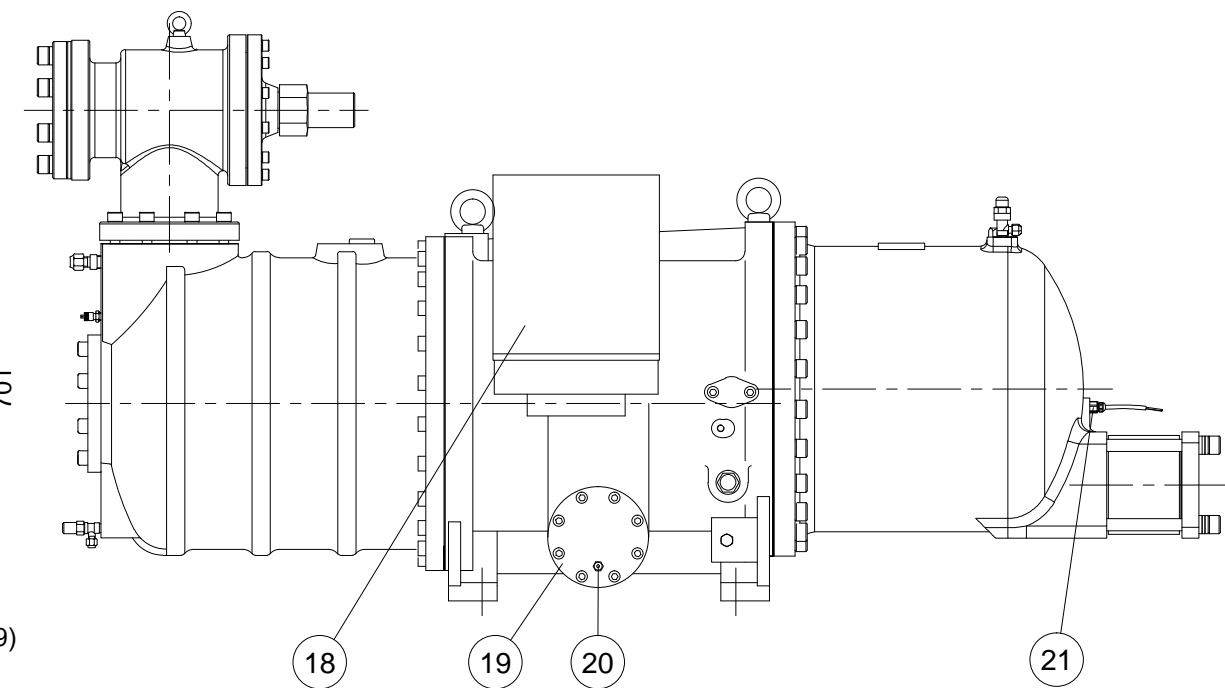

Dimensional Outline Drawing & Component Description for Stepless or Modulating-Type Capacity Control Application	
Hanbell Model	RC2-790AF
Date	06/27/2024
Drawn By	ILM

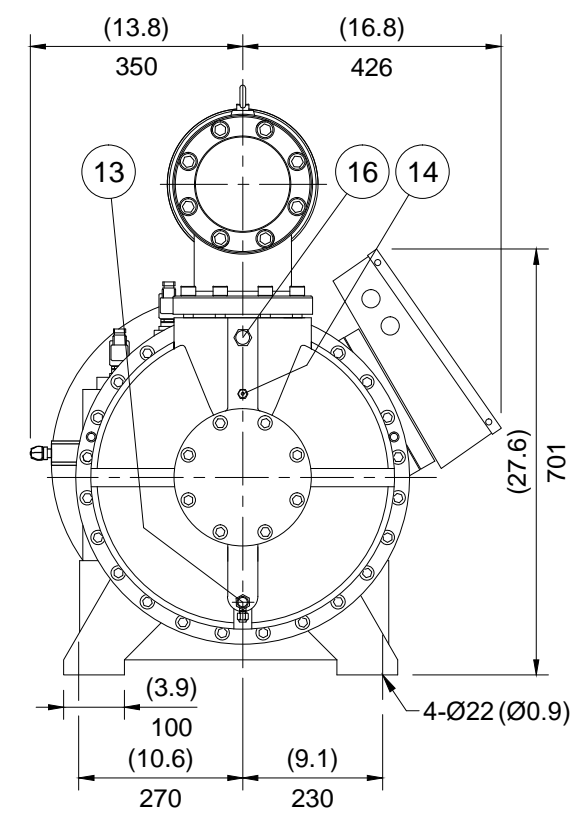
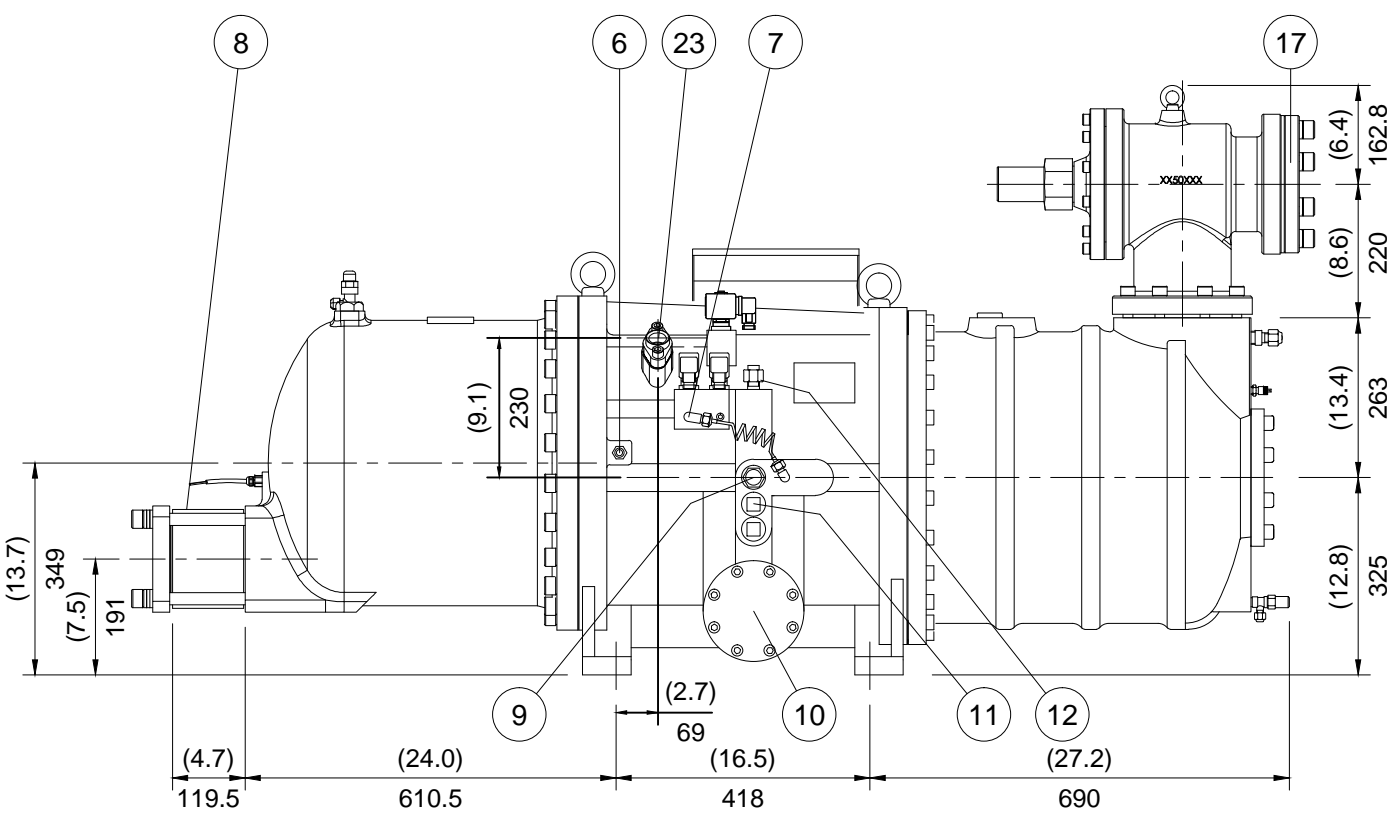

Micro Control Systems, Inc.
 5877 Enterprise Parkway
 Fort Myers, Florida 33905
 Tel. (239) 694-0089 Fax (239) 694-0031
 E-mail: compressors@mcscontrols.com

Model	RC2-790AF
Name	Compressor outline
	HANBELL
	Ver. 05

UNIT
 SI: mm Imperial: (in)