

No.	Name	Note	No.	Name	Note
1	Angle valve	1/4" Flare	16	Angle valve	1/4" Flare
2	Discharge flange	4"	17	Refrigerant service valve	1/4" Flare
3	Solenoid valve	50%(NC)	18	Solenoid valve	Stepless(NC or NO)
4	Solenoid valve	75%(NC)	19	Liquid injection connector	5/8" Flare, Option
5	Solenoid valve	30%(NC)	20	Suction flange	5"
6	Liquid(oil or refrigerant) injection connector	3/8" Flare, Option	21	Cable box	Standard
7	Capillary		22	Service flange	
8	Check valve	4"	23	Oil drain valve	
9	Oil flow sight glass		24	Oil level switch	
10	Oil heater	150W/300W	25	Discharge temp. sensor	110°C
11	Oil filter cartridge		26	Safety Valve	1" NPT, Option
12	Oil pressure differential switch	Connector, Option	27	Economizer port	1 1/8", Solder
13	Oil connector(out)	3/4" Flare, Option	28	Oil level sight glass	
14	Stop pin	Option	29	Over flow port	Option
15	Oil connector(in)	3/4" Flare, Option			

*All stop valves are optional.

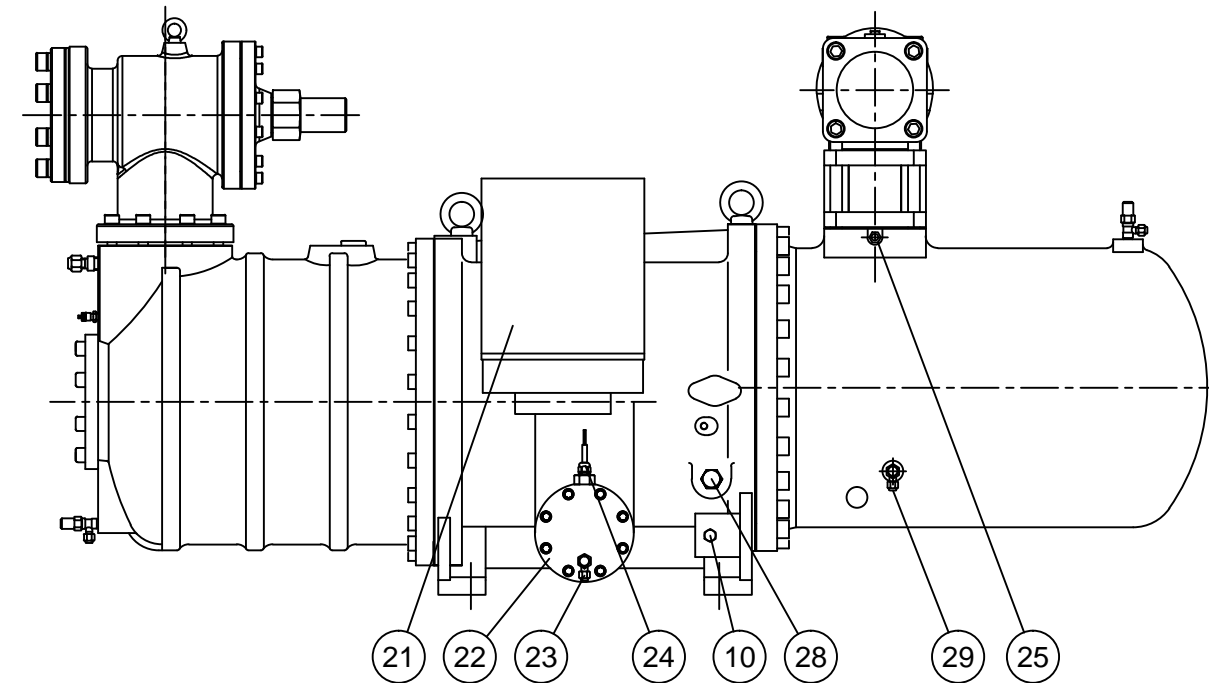

Dimensional Outline Drawing & Component Description for Stepless or Modulating-Type Capacity Control Application	
Hanbell Model	RC2-830A
Date	06/27/2024
Drawn By	ILM

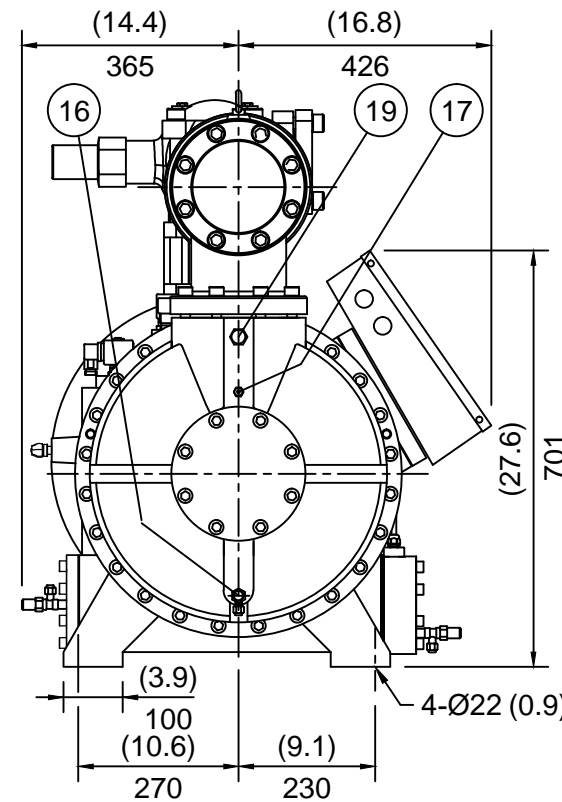
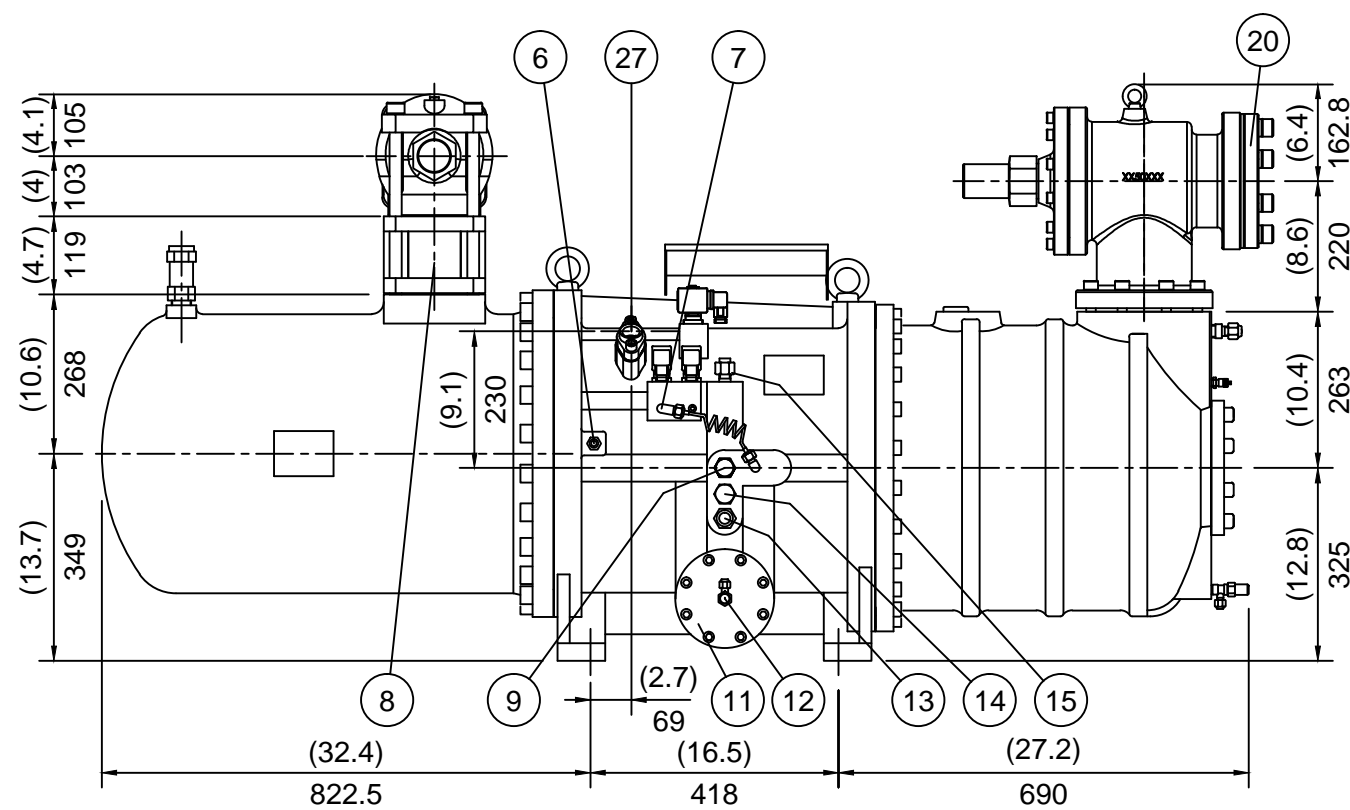

Micro Control Systems, Inc.
 5877 Enterprise Parkway
 Fort Myers, Florida 33905
 Tel. (239) 694-0089 Fax (239) 694-0031
 E-mail: compressors@mcscontrols.com

Model	RC2-830A
Name	Compressor outline
	Ver. 06

UNIT
 SI: mm Imperial: (in)