

MCS-WIRELESS-MODEM-B - MCS-WIRELESS-MODEM-INT-B QUICK START SETUP

1. WIRING MCS-WIRELESS-MODEM-B (or MCS-WIRELESS-MODEM-INT-B)

MCS-WIRELESS MODEM-B / INT-B ships as shown, use power plug or cut off plug and wire to a 12 volt power supply (not included).

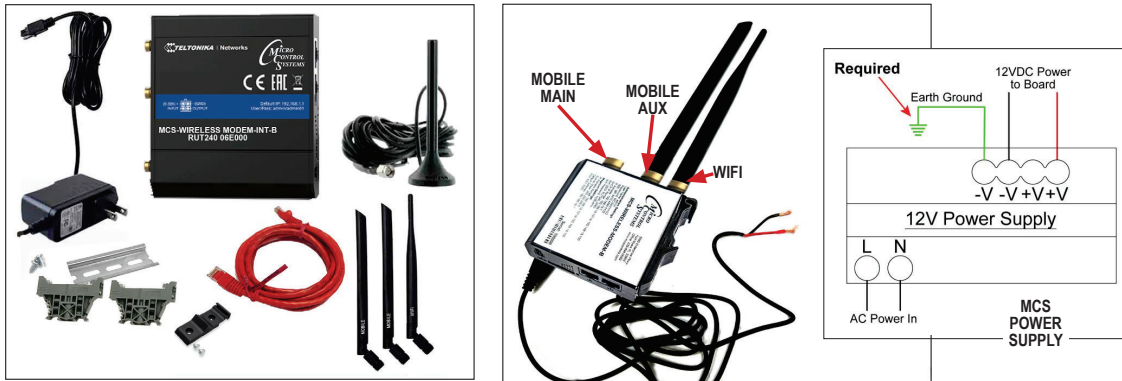

1. If using a 12 volt power supply, cut the wire at the plug end, exposing the red and black wires.
2. Connect the red wire to the +V connection of the power and black to the -V connection.

DUAL BAND ANTENNA

MCS recommends using the DUAL BAND ANTENNA BOOSTER for better reception. Attach the Dual Band Antenna, thumb tight only to Mobile Main Antenna connection.

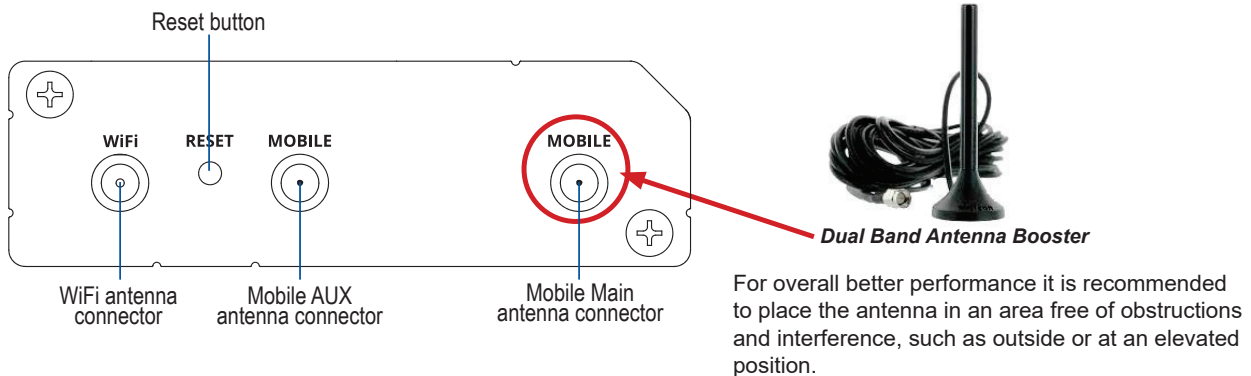

2. CONNECT TO THE MCS-MAGNUM

Connect the orange Crossover CAT 5 cable from MCS-WIRELESS-MODEM-B to the Ethernet port on the MAGNUM and the other end of the cable to the LAN port on the MCS-WIRELESS-MODEM-B or MCS-WIRELESS-MODEM-INT-B.

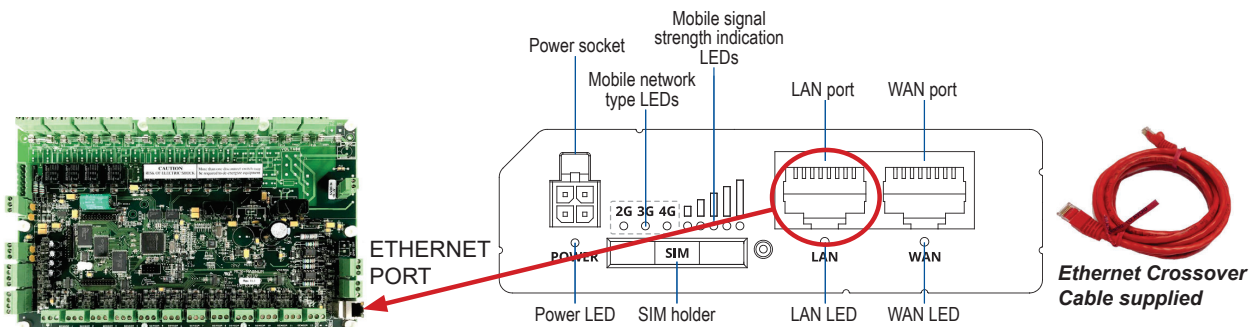

3. HARDWARE INSTALLATION

1. Push the SIM button with the SIM needle supplied.
2. Pull out the SIM holder.
3. Insert your SIM card into the SIM holder. **(SIM card is not supplied.)**

The SIM card must have Data and SMS)

Check with www.mcscontrols.com for the latest phone carrier for your area that can be used for these modems. See partial list on back.

4. Slide the SIM holder back into the router.
5. Attach Dual Band Antenna or Mobile and WiFi antennas, depending on installation.
6. Connect the power adapter to the socket on the front of the device. Then plug the other end of the power adapter into a power outlet.

Note: MCS-WIRELESS-MODEM-B or MCS-WIRELESS-MODEM-INT-B can be powered using a 12vdc power supply (see wiring).

7. Use the supplied Din Rail mounting kit if installing in an enclosure.

4. NETWORK ADDRESS ON MCS-MAGNUM

THE IP ADDRESS FOR YOUR NEW MCS-WIRELESS-MODEM-B HAS BEEN FACTORY SET AND IS SUPPLIED WITH THE UNIT ON THE LABEL OF THE MODEM.

YOU MUST SET THE NETWORK ADDRESS ON YOUR CONTROLLER TO MATCH THIS FACTORY ADDRESS.

1. The MAGNUM is set up for TCP/IP port starting at 5001 ~ 5020.
2. The IP on your label will show the factory setting for the modem.
3. When you are installing the Modem you will need to search for the MAGNUM port in the range of 5001 ~ 5020.
4. If you have multiple MAGNUMs, each MAGNUM must be assigned an IP address different from

MAGNUM IP must be within the specified IP address range on the label.



each other.

- Each IP address must get forwarded to separate TCP/IP ports. See the diagram for multiple MAGNUMS.

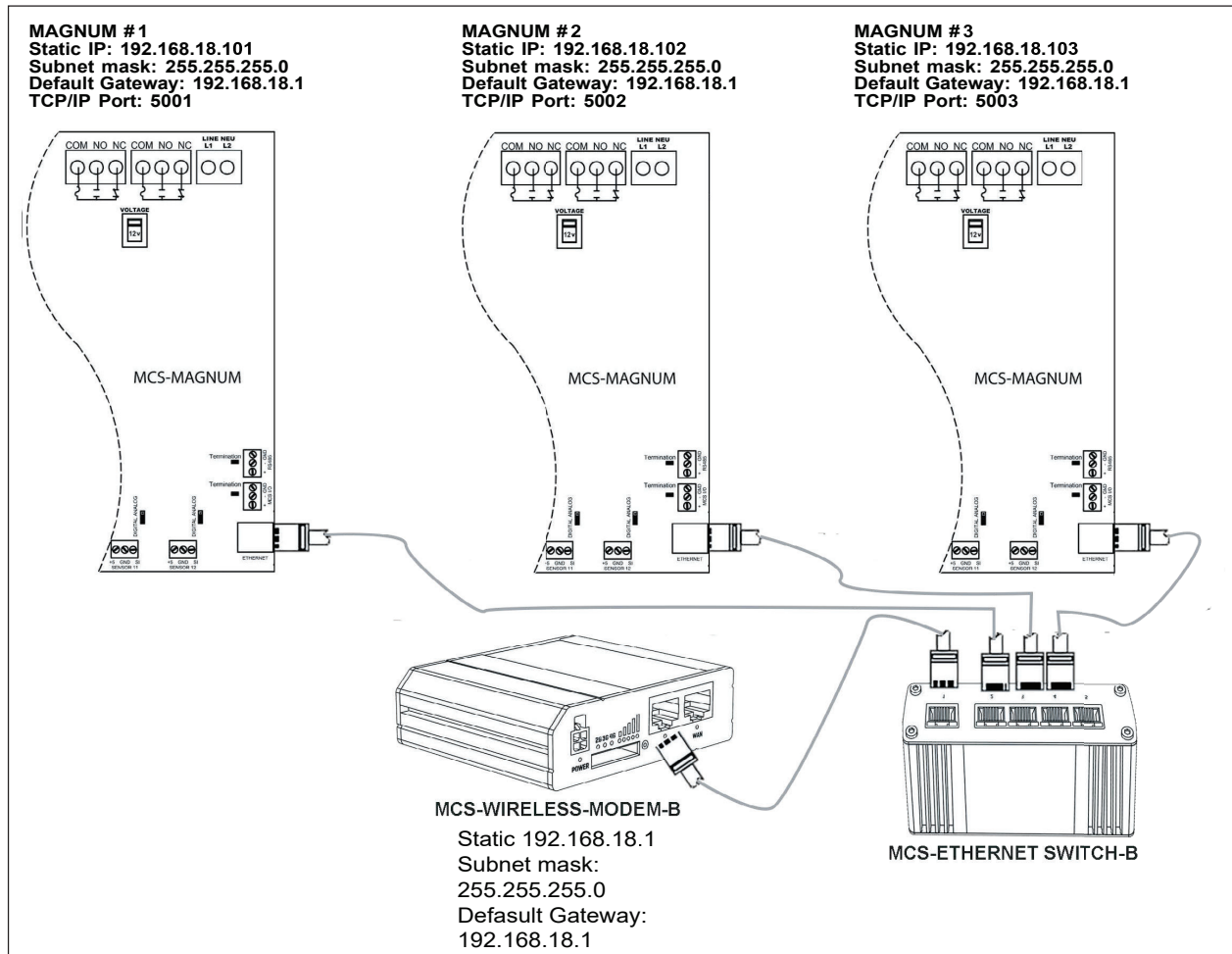

- For example: 192.168.18.101 will get forwarded to 5001

5. INSTALL OPEN VPN client on your machine

- Open a browser on your computer, and go to the link below.
<https://openvpn.net/vpn-client/>
- Download the VPN CLIENT and install on your computer.
- Attach the USB drive, that was included.
- Open the USB drive, drop or drag the supplied file into this window.

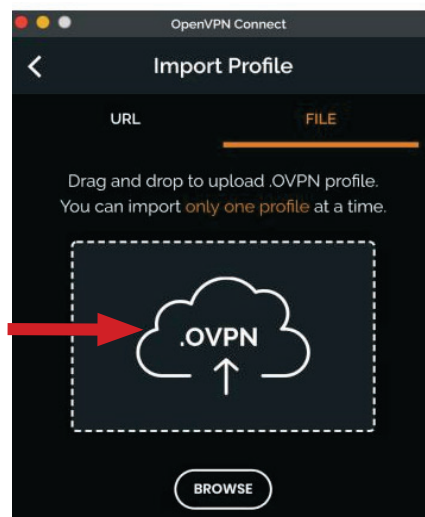

5. Open MCS-CONNECT on your computer.
6. Click on '**SETUP**' > '**NETWORK OPTIONS**'
7. MCS-Connect will show a new device in the **Network Options screen**.

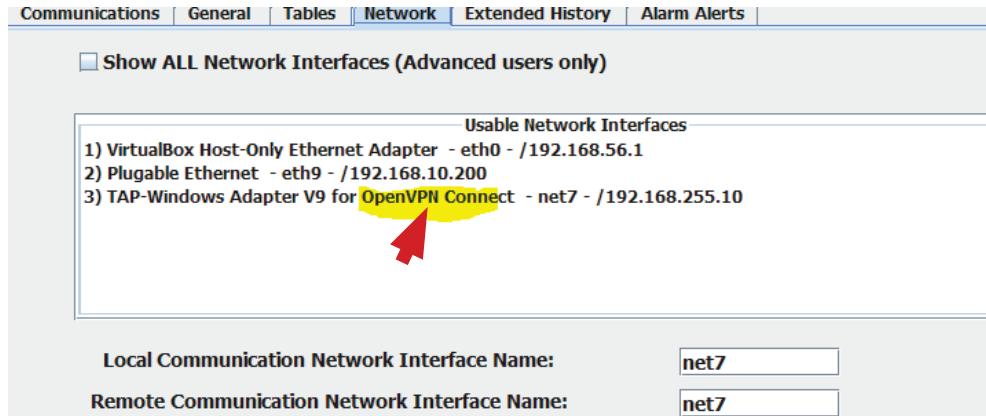

8. Look for the one that says '**OpenVPN**', and select it.
9. Now try to connect to the Magnum over Remote Ethernet with the settings below.

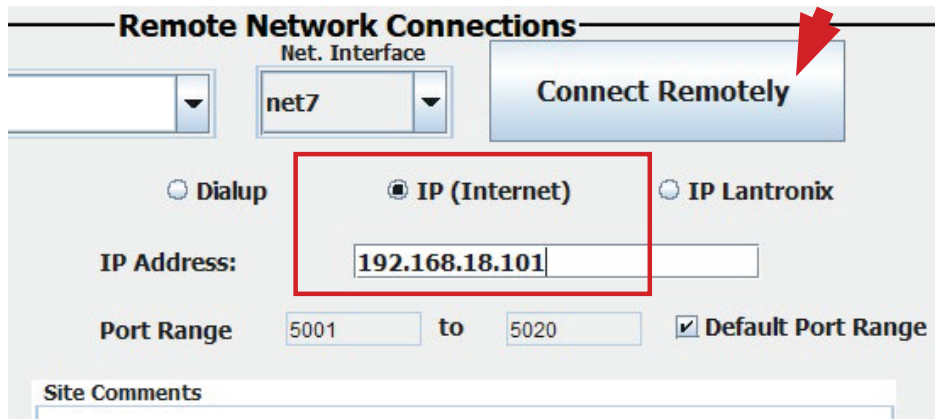

LIST OF WHERE MODEM-B WORKS

There are some operators which have their own compliance requirements and, for a device to be able to operate in that carrier's network, it should be certified by that carrier. List below shows carriers that support the MCS-WIRELESS-MODEM-B and MCS-WIRELESS-MODEM-INT-B. Check for latest carriers:

<https://mcscontrols.com/communications.html#wirelessInt>

Carriers International

Saudi Arabia

Carriers: Mobily, STC, Zain
UMTS: B1
LTE: B1, B3, B38, B40

UAE

Carriers: DU, ETISALAT
UMTS: B1
LTE: B3, B7, B20

Baharain

Carriers: Batelco, Viva, Zain
UMTS: B1
LTE: B3

Qatar

Carriers: Ooredoo, Vodafone
LTE: B3, B7, B20

Jordan

Carriers: Orange, Uminiah, Zain
UMT: B1
LTE: B3

Oman

Carriers: Omantel, Ooredoo
UMTS: B1, B8
LTE: B3, B40

Kuwait

Carriers: Ooredoo, Vivo, Zain
UMTS: B1
LTE: B3, B20

Carriers in US

AT&T, T-MOBILE and BELL



Click for latest information for setup